



03

www.cermag.com

Zappe e Coltelli Denti per Erpici Molle per Vibrocoltivatori

*COUTEAUX - DENTS DE RECHANGE POUR HERSES ROTATIVES -
RESSORTS POUR CULTIVATEURS*

BLADES - SPARE TINES FOR ROTARY HARROWS - CULTIVATOR SPRINGS

MESSER-SCHLEGELMESSER - KREISELEGGENZINKEN - KULTIZINKEN

*HOJAS - DIENTES PARA GRADAS DE DIENTES -
MUELLES PARA VIBROCULTIVADORES*



Zappe - Coltelli - Denti - Lame - Molle

BLADES - SPARE TINES FOR ROTARY HARROWS - CULTIVATOR SPRINGS



03

03

ZAPPE e COLTELLI COUTEAUX - BLADES - MESSERN - AZADILLAS y HOJAS

ARTICOLO	MODELLO	LATO	DISEGNO		MISURE x = mm y = mm z = mm	Ø FORO mm	INTERASSE mm	PIATTO mm	PESO g	FORMA	OEM
											

BADALINI

55001 55002	Multifresa F.777	Dx Sx			x = 55 y = 138	10,5	30	50x6	360	Curva	-
------------------------------	------------------	----------	-----------------------------------------------------------------------------------	-----------------------------------------------------------------------------------	-------------------	------	----	------	-----	-------	---

BARBIERI

56927 56928	Giaguaro FB1600 AR/EL	Dx Sx			x = 75 y = 200 z = 20	10,5	76	40x6	380	Curva	-
56929 56930	RL F1 Squadra	Dx Sx			x = 63 y = 188	10,5	38	50x6	470	Squadro	-
56931 56932	RLG3 Gazzella Arco	Dx Sx			x = 62 y = 225	10,5	68	45x5	380	Curva	-
56933 56934	RLF1 S.1500 Rinf. Arco	Dx Sx			x = 80 y = 230	10,5	76	60x6	650	Curva	-
56935 56936	RL C1 Condor Arco	Dx Sx			x = 65 y = 220	10,5	76	40x6	400	Curva	-
56937 56938	RL A1 Airone-Ghepard Arco	Dx Sx			x = 62 y = 182	8,5	68	35x5	260	Curva	-
56939 56940	RL A3 Airone Arco	Dx Sx			x = 60 y = 195	8,5	68	35x5	270	Curva	-
56941 56942	RL F1 S.1500 Zebra Arco	Dx Sx			x = 65 y = 223	10,5	76	50x6	580	Curva	-
56943 56944	B 80 Super RL G1 Arco	Dx Sx			x = 63 y = 205	10,5	68	40x5	310	Curva	-
56945 56946	Cortina Arco	Dx Sx			x = 60 y = 195	8,5	68	40x5	330	Curva	-
56949 56950	MCG/18 Pantera Arco	Dx Sx			x = 104 y = 176	10,5	42	60x6	600	Curva	-
55172 55609	MCG/10 Pioneer S. 1200 Angol.	Dx Sx			x = 70 y = 195	10,5	80	45x5	330	Curva	-

segue **ZAPPE e COLTELLI**
COUTEAUX - BLADES - MESSERN - AZADILLAS y HOJAS

ARTICOLO	MODELLO	LATO	DISEGNO		MISURE x = mm y = mm z = mm	Ø FORO mm	INTERASSE mm	PIATTO mm	PESO g	FORMA	OEM

BCS

55007 55523	715 Grillino B4	Dx Sx			x = 55 y = 165 z = 20	8,5	55	25x6	200	Curva	582 43432 582 43431
55008 55524	705 Standard	Dx Sx			x = 72 y = 190 z = 20	10,5	66	30x6	300	Curva	580 42306 580 42307
55009 55525	705 Paternò	Dx Sx			x = 75 y = 144 z = 30	10,5	41	50x6	370	Curva	582 42304 580 42305
55011 55526	735	Dx Sx			x = 56 y = 130	10,5	27	40x6	255	Curva	580 48433 580 43434
55760 55776	715 Lungo tipo America	Dx Sx			x = 55 y = 185 z = 20	8,5	55	25x6	240	Curva	580 43433 580 43434
56951 56952	725 Arco	Dx Sx			x = 56 y = 115 z = 15	10,5	27	40x6	280	Curva	580 48425 580 48426
56953 56954	745 Sicilia AR/EL.	Dx Sx			x = 74 y = 173 z = 25	12,5	46	60x8	650	Curva	580 48460 580 48461
56955 56956	732-Fresa 20 AR/EL.	Dx Sx			x = 55 y = 193 z = 18	8,5	55	30x6	270	Curva	580 59275 580 59276
56957 56958	Fresa 20 Corta AR/EL.	Dx Sx			x = 55 y = 170 z = 18	8,5	55	30x6	250	Curva	580 59277 580 59278

BENASSI

55762 55763	RT 12/4	Dx Sx			x = 55 y = 165	8,5	68	30x5	170	Curva	6CM0300 6CM0301
55021 55764	BL 50-55	Dx Sx			x = 60 y = 192	8,5	68	35x5	260	Curva	6CM012 6CM013
55024 55765	RL 95 nuovo tipo	Dx Sx			x = 70 y = 235	10,5	80	50x6	540	Curva	6CM020 6CM021
55025 55766	Serie 300/304	Dx Sx			x = 60 y = 205	10,5	68	45x6	440	Curva	6CM010 6CM011
55027 55767	BL 75 nuovo tipo	Dx Sx			x = 60 y = 195	8,5	68	40x5	300	Squadro	6CM004 6CM005
55029 55769	RT 401	Dx Sx			x = 47 y = 164	8,5	68	30x4	150	Squadro	6CM006 6CM007
56945 56946	Z3 - BL75-85 Arco	Dx Sx			x = 60 y = 195	8,5	68	40x5	330	Curva	6CM002 6CM003
57001 57002	BL30 Princess Arco	Dx Sx			x = 65 y = 197	8,5	68	30x4	210	Curva	644011 644012
57031 57032	BL30 Princess Arco	Dx Sx			x = 74 y = 215 z = 55	10,5	70	40x5	330	Curva	644015 644016































Zappe - Coltelli - Denti - Lame - Molle

BLADES - SPARE TINES FOR ROTARY HARROWS - CULTIVATOR SPRINGS



03

03











segue ZAPPE e COLTELLI COUTEAUX - BLADES - MESSERN - AZADILLAS y HOJAS

ARTICOLO	MODELLO	LATO	DISEGNO		MISURE x = mm y = mm z = mm	Ø FORO mm	INTERASSE mm	PIATTO mm	PESO g	FORMA	OEM
											
55771 55772	BM 10	Dx Sx			x = 70 y = 220	10,5	58	30x8	450	Curva	101909 101910
55040 55535	Serie 310 e 320 unificato	Dx Sx			x = 102 y = 255	12,5	90	50x7	750	Curva	12031 12032
55041 55536	Serie 315	Dx Sx			x = 90 y = 145	10,5	28	50x6	410	Curva	13014 13015
55044 55537	Serie 306	Dx Sx			x = 72 y = 170 z = 12	8,5	55	30x6	270	Squadro	F015517 F015518
56959 56960	S.318-1681DX/1681SX Arco	Dx Sx			x = 70 y = 145	10,5	28	45x6	350	Curva	-
56961 56962	S.300 Arco	Dx Sx			x = 75 y = 220	8,5	81	30x6	350	Curva	671013 671014
56963 56964	S.310/S - 12522/3 Arco	Dx Sx			x = 80 y = 245	12,5	90	50x6	570	Curva	-
56965 56966	S.309 17002D/17003S AN./EL.	Dx Sx			x = 65 y = 168 Z = 12	9	55	30x6	260	Squadro	-
56967 56968	S.307 Arco	Dx Sx			x = 75 y = 185	8,5	81	30x6	320	Curva	01353362 01353262
56969 56970	410-411 - 15602DX/15603SX ANG./ELIC.	Dx Sx			x = 65 y = 194 z = 18	8,5	55	35x6	320	Curva	-
56971 56972	Motozappa 201/202E Arco	Dx Sx			x = 60 y = 197	8,5	65	30x4	160	Curva	-
55008 55524	S.305 HP 7,5 Arco - ELIC.	Dx Sx			x = 72 y = 190 z = 20	10,5	66	30x6	300	Curva	-
56973 56974	Motocoltivatore 401 Arco / ELIC.	Dx Sx			x = 52 y = 170 z = 15	8,5	58	25x5	180	Curva	-
56975 56976	BM12 E 412 Arco	Dx Sx			x = 90 y = 176	12,5	41	40x8	500	Curva	-

segue **ZAPPE e COLTELLI**
COUTEAUX - BLADES - MESSERN - AZADILLAS y HOJAS

ARTICOLO	MODELLO	LATO	DISEGNO		MISURE x = mm y = mm z = mm	Ø FORO mm	INTERASSE mm	PIATTO mm	PESO g	FORMA	OEM
											





BREVIGLIERI

55045 55538	MM Bietole	Dx Sx			x = 50 y = 190	8,5	70	30x6	290	Squadro	11076
55047 55540	B3 - B4	Dx Sx			x = 100 y = 220 z = 22	14,5	46	80x8	1080	Curva	30329
55048 55541	B1	Dx Sx			x = 115 y = 185 z = 20	12,5	40	70x6	660	Curva	10279
56165 56166	B2 - B12 - BV2	Dx Sx			x = 130 y = 210	12,5	57	80x7	1000	Curva	0839
55052 55545	Multipla MB	Dx Sx			x = 60 y = 133	10,5	35	50x6	340	Squadro	S/10021













BRUMI

55060 55061	Diesel	Dx Sx			x = 70 y = 220	10,5	70	40x6	410	Curva	-
------------------------------	--------	----------	-------------------------------------------------------------------------------------	-------------------------------------------------------------------------------------	-------------------	------	----	------	-----	-------	---

CARRARO

55180 55187	Carrarino HP	Dx Sx			x = 61 y = 195 z = 20	8,5	55	30x6	320	Curva	-
56551 56552	Super HP	Dx Sx			x = 90 y = 185	12,5	45	50x6	-	Curva	-

CASORZO

56979 56980	Normale SU3-CU6 AR/EL.	Dx Sx			x = 62 y = 205 z = 15	8,5	72	35x6	340	Curva	-
56983 56984	Meridione SU4 V.T.Arco	Dx Sx			x = 67 y = 220	8,5	72	35x6	350	Curva	-
56985 56986	Vigneto CU6 Corta Ang. Elic.	Dx Sx			x = 60 y = 195 z = 15	8,5	72	35x6	340	Curva	-
56987 56988	Vigneto Lunga SU4 Ang. Elic.	Dx Sx			x = 60 y = 220 z = 15	8,5	72	35x6	400	Curva	-
56989 56990	Pony Arco	Dx Sx			x = 80 y = 194	8,5	72	30x6	300	Curva	-
56991 56992	CU 125 Arco Elic.	Dx Sx			x = 52 y = 195 z = 15	8,5	72	30x6	300	Curva	-

Zappe - Coltelli - Denti - Lame - Molle

BLADES - SPARE TINES FOR ROTARY HARROWS - CULTIVATOR SPRINGS







03

03









segue ZAPPE e COLTELLI COUTEAUX - BLADES - MESSERN - AZADILLAS y HOJAS

ARTICOLO	MODELLO	LATO	DISEGNO	MISURE x = mm y = mm z = mm	Ø FORO mm	INTERASSE mm	PIATTO mm	PESO g	FORMA	OEM
----------	---------	------	---------	--------------------------------------	-----------------	-----------------	--------------	-----------	-------	-----













CELLI

55103 55563	Tipo «E» - HV - HF Tipo «B» - HP25/55 interfilare	Dx Sx	 	x = 135 y = 180 z = 20	14,5	57	80x7	1040	Squadro	322516 422512 328617 422513
55104 55564	Tipo «E» - HV - HF	Dx Sx	 	x = 135 y = 195 z = 20	14,5	57	80x7	960	Curva	422514 422515
55109 55567	Tipo «B» HP 25/55 interfil.	Dx Sx	 	x = 135 y = 195 z = 20	14,5	57	80x6	850	Curva	322515 322519

DONDI

55047 55540	B	Dx Sx	 	x = 100 y = 220 z = 22	14,5	46	80x8	1140	Curva	-
55122 55582	0x7 per DCM/DCSM	Dx Sx	 	x = 105 y = 190 z = 20	12,5	40	70x7	800	Curva	-
55231 55643	B1/N Ultimo Tipo B1 Arco Elic.	Dx Sx	 	x = 120 y = 195 z = 15	14,5	46	80x8	1160	Curva	-
55169 55606	M per DM Arco Elic.	Dx Sx	 	x = 113 y = 205 z = 22	12,5	54	70x6	720	Curva	-



EUROSYSTEMS

56971 56972	Euro 5 Arco	Dx Sx	 	x = 60 y = 197	8,5	65	30x4	160	Curva	-
56995 56996	Euro 6 Arco/Elic.	Dx Sx	 	x = 69 y = 169 z = 17	8,5	73	35x5	270	Curva	-
56997 56998	Euro 102D Arco	Dx Sx	 	x = 81 y = 205	10,5	73	40x6	400	Curva	-
56999 57000	Euro 3 - 50 Arco/Elic.	Dx Sx	 	x = 78 y = 198 z = 15	8,5	65	30x5	230	Curva	-
55135 55777	P 75 Arco	Dx Sx	 	x = 78 y = 183	10,5	65	25x5	190	Curva	-
55319 55684	MTZ 34F	Dx Sx	 	x = 80 y = 217	10,5	73	40x6	440	Curva	-



segue **ZAPPE e COLTELLI**
COUTEAUX - BLADES - MESSERN - AZADILLAS y HOJAS

ARTICOLO	MODELLO	LATO	DISEGNO	MISURE x = mm y = mm z = mm	Ø FORO mm	INTERASSE mm	PIATTO mm	PESO g	FORMA	OEM
----------	---------	------	---------	--------------------------------------	-----------------	-----------------	--------------	-----------	-------	-----

















FALC

55104 55564	Interfilatore Arco Elic.	Dx Sx	 	x = 134 y = 195 z = 12	14,5	57	80x7	980	Curva	-
------------------------------	--------------------------	----------	---------------------------------------------------------------------------------------------------------------------------------------------------------------------	------------------------------	------	----	------	-----	-------	---



FALCONERO

55104 55564	Manta Arco Elic.	Dx Sx	 	x = 134 y = 195 z = 12	14,5	57	80x7	980	Curva	-
------------------------------	------------------	----------	---------------------------------------------------------------------------------------------------------------------------------------------------------------------	------------------------------	------	----	------	-----	-------	---



FERRARI

55134 55139	Tipo 71/90	Dx Sx	 	x = 72 y = 190 z = 20	10,5	65	30x6	300	Curva	-
55140 55141	Nuovo tipo 72 - Fresa cm. 90	Dx Sx	 	x = 72 y = 145	10,5	25	50x6	340	Curva	-
57609 57610	72 Super Arco Elicoidale	Dx Sx	 	x = 92 y = 163	10,5	25	50x6	430	Curva	-
55138 55132	Tipo 92/91	Dx Sx	 	x = 88 y = 195	10,5	65	35x6	350	Curva	-
55135 55777	Tipo 300	Dx Sx	 	x = 78 y = 183	10,5	65	25x5	190	Curva	-
55136 55133	MC 68 - Arco	Dx Sx	 	x = 100 y = 145	10,5	25	50x6	460	Curva	-
56955 56956	320-330-340 Arco Elicoidale	Dx Sx	 	x = 55 y = 193 z = 18	8,5	55	30x6	270	Curva	-
55319 55684	MTZ 34F	Dx Sx	 	x = 80 y = 217	10,5	73	40x6	440	Curva	-

FORIGO-ROTERTALIA

57146 57145	G35 Arco Elic.	Dx Sx	 	x = 125 y = 180 z = 15	14,5	46	80x7	910	Curva	-
------------------------------	----------------	----------	-------------------------------------------------------------------------------------------------------------------------------------------------------------------------	------------------------------	------	----	------	-----	-------	---

FORT

56949 56950	Corsare F/700 Arco	Dx Sx	 	x = 104 y = 176	10,5	42	60x6	600	Curva	-
------------------------------	--------------------	----------	-------------------------------------------------------------------------------------------------------------------------------------------------------------------------	--------------------	------	----	------	-----	-------	---

































Zappe - Coltelli - Denti - Lame - Molle

BLADES - SPARE TINES FOR ROTARY HARROWS - CULTIVATOR SPRINGS

03

03













segue ZAPPE e COLTELLI
COUTEAUX - BLADES - MESSERN - AZADILLAS y HOJAS

ARTICOLO	MODELLO	LATO	DISEGNO		MISURE x = mm y = mm z = mm	Ø FORO mm	INTERASSE mm	PIATTO mm	PESO g	FORMA	OEM
											
55161 55603	Fresa 19	Dx Sx			x = 71 y = 175 z = 10	10,5	70	40x6	340	Curva	00014191 00014193
55163 55605	Fresa 60 (ultimo tipo)	Dx Sx			x = 102 y = 205 z = 10	12,5	53	60x6	590	Curva	00020136 00020137
55169 55606	Fresa 27/28/40	Dx Sx			x = 110 y = 190 z = 22	12,5	54	70x6	710	Curva	00009506 00009507
55170 55607	Fresa 29/50 asola	Dx Sx			x = 105 y = 190 z = 10	12,5	42	60x6	600	Curva	00009417 00009418
55171 55608	Fresa 22 (nuovo tipo)	Dx Sx			x = 80 y = 185	10,5	33	45x5	340	Curva	00009402 00009401
55172 55609	Fresa 21	Dx Sx			x = 70 y = 195	10,5	80	45x5	330	Curva	00008834 00008833
55174 55610	Fresa 22M (vecchio tipo)	Dx Sx			x = 100 y = 165 z = 15	10,5	42	60x6	540	Curva	00004312 00004265
55175 55611	Fresa 22M (nuovo tipo)	Dx Sx			x = 95 y = 200 z = 20	10,5	42	45x5	400	Curva	00014486 00014487
55176 55612	Fresa 21M	Dx Sx			x = 85 y = 152	10,5	39	50x5	320	Curva	00013545 00013546
55178 55614	Fresa 80	Dx Sx			x = 112 y = 178 z = 25	12,5	39	70x6	750	Curva	00011098 00011106
55732 55733	Fresa 80 - 40 SV	Dx Sx			x = 112 y = 170 z = 25	12,5	40	70x6	580	Curva	00017011 00017012
55516 55517	Fresa 42	Dx Sx			x = 57 y = 120	10,5	33	45x5	196	Squadro	00008831 00008832
55721 55722	Fresa 28 1° tipo	Dx Sx			x = 110 y = 240	10,5	99	60x6	675	Curva	00000434 00000435
55717 55718	Fresa 22-23 (vecchio tipo)	Dx Sx			x = 75 y = 185	8,5	33	35x6	250	Curva	00000469 00000470
56949 56950	Fresa 29 - HP 16-18 5323/4 Arco	Dx Sx			x = 104 y = 176	10,5	42	60x6	600	Curva	00005324 00005323









segue **ZAPPE e COLTELLI**
COUTEAUX - BLADES - MESSERN - AZADILLAS y HOJAS

ARTICOLO	MODELLO	LATO	DISEGNO	MISURE x = mm y = mm z = mm	Ø FORO mm	INTERASSE mm	PIATTO mm	PESO g	FORMA	OEM
----------	---------	------	---------	--------------------------------------	-----------------	-----------------	--------------	-----------	-------	-----

GRILLO

55009 55525	Paternò 131 NT	Dx Sx			x = 72 y = 145 z = 30	10,5	41	50x6	370	Curva	-
55007 55523	Grilletino B4 Arco Elic.	Dx Sx			x = 55 y = 165 z = 20	8,5	55	25x6	200	Curva	-
57001 57002	Princess Arco	Dx Sx			x = 65 y = 197	8,5	68	30x4	210	Curva	-
55008 55524	GN10 Standard (131) Arco Elic.	Dx Sx			x = 72 y = 190 z = 20	10,5	66	30x6	290	Curva	-
57003 57004	Grillino C. Guelfo (127) Arco Elic.	Dx Sx			x = 70 y = 140 z = 30	8,5	21	35x6	220	Curva	-
57005 57006	Motozappa 9000-9000R Arco Elic.	Dx Sx			x = 65 y = 220 z = 24	10,5	76	45x6	470	Curva	-
57007 57008	Motozappa 11000 Lunga Arco El.	Dx Sx			x = 67 y = 205 z = 21	10,5	66	35x6	340	Curva	-
55180 55187	Motocolt. 126/127 Rinf.x4 Arco El.	Dx Sx			x = 61 y = 195 z = 20	8,5	55	30x6	320	Curva	-
57009 57010	Motozappa 12000 Arco	Dx Sx			x = 69 y = 210	10,5	66	40x6	400	Curva	-
57011 57012	Super Mini Grillo Arco Elic.	Dx Sx			x = 54 y = 170 z = 10	8,5	50	30x4	170	Curva	-

HOWARD - ROTAVATOR

55201 55620	Mod. U Francese 63592/3900/01	Dx Sx			x = 140 y = 180	13,5	57	80x7	1070	Squadro	-
55426 55427	Modello HL-P Francese 9900/01	Dx Sx			x = 140 y = 175	11,5	57	75x6	820	Curva	-
55202 55625	Modello HL-P Francese 9900/01	Dx Sx			x = 140 y = 170	11,5	57	75x6	820	Squadro	-
55204 55627	Modello U 4998-4999	Dx Sx			x = 132 y = 175 z = 10	13,5	57	80x7	910	Curva	-



Zappe - Coltelli - Denti - Lame - Molle

BLADES - SPARE TINES FOR ROTARY HARROWS - CULTIVATOR SPRINGS



03

03











segue ZAPPE e COLTELLI COUTEAUX - BLADES - MESSERN - AZADILLAS y HOJAS

ARTICOLO	MODELLO	LATO	DISEGNO		MISURE x = mm y = mm z = mm	Ø FORO mm	INTERASSE mm	PIATTO mm	PESO g	FORMA	OEM
											







KUHN

55213 55214	Type EL 45	Dx Sx			x = 135 y = 165	11,5	57	75x6	750	Squadro	-
------------------------------	------------	----------	-----------------------------------------------------------------------------------	-----------------------------------------------------------------------------------	--------------------	------	----	------	-----	---------	---





KVERNELAND - MALETTI

55229 55641	Pe M	Dx Sx			x = 110 y = 205 z = 15	14,5	46	70x8	1030	Curva	010077/8
55231 55643	B	Dx Sx			x = 120 y = 195 z = 15	14,5	46	80x8	1160	Curva	0500079/80
55235 55790	PL	Dx Sx			x = 105 y = 180 z = 20	14,5	46	60x7	760	Curva	-
55794 55795	L	Dx Sx			x = 90 y = 248	12,5	105	40x8	650	Curva	-
55047 55540	B (908/909) Arco Elic.	Dx Sx			x = 100 y = 220 z = 22	14,5	46	80x8	1170	Curva	-

LAMPACRESCIA 2

55007 55523	Kombi Arco Elic.	Dx Sx			x = 55 y = 165 z = 20	8,5	55	25x6	200	Curva	-
55364 55372	DL 10 Super Arco	Dx Sx			x = 74 y = 217	10,5	70	45x6	450	Curva	-
57023 57024	DL 10 Super Interna Arco	Dx Sx			x = 70 y = 195	10,5	70	45x6	400	Curva	-

MAB

55218 55219	Formica 3T esterna	Dx Sx			x = 68 y = 222	10,5	85	40x5	340	Curva	-
55220 55215	Curva lunga	Dx Sx			x = 67 y = 232	10,5	85	40x6	460	Curva	-

segue **ZAPPE e COLTELLI**
COUTEAUX - BLADES - MESSERN - AZADILLAS y HOJAS

ARTICOLO	MODELLO	LATO	DISEGNO		MISURE x = mm y = mm z = mm	Ø FORO mm	INTERASSE mm	PIATTO mm	PESO g	FORMA	OEM

MASCHIO

55241 55648	BI/B/C/SC (01110428/9)	Dx Sx			x = 140 y = 215 z = 25	14,5	56	80x8	1330	Squadro	011104289
55242 55649	BI/B/C/SC (01110426/7)	Dx Sx			x = 142 y = 225 z = 18	14,5	56	80x8	1250	Curva	011104267
55243 55650	NC-PS-Z (02108430/1)	Dx Sx			x = 135 y = 180 z = 18	14,5	56	80x6	880	Squadro	021084301
55244 55651	NC-PS-Z (02108432/3)	Dx Sx			x = 135 y = 186 z = 14	14,5	56	80x6	850	Curva	021084323
55248 55652	A/E/KS (19100415/6)	Dx Sx			x = 115 y = 190 z = 20	12,5	44	60x6	660	Squadro	191004156
55249 55653	A/E/KS (19100417/8)	Dx Sx			x = 115 y = 194 z = 12	12,5	44	60x6	620	Curva	191004178
55796 55797	K	Dx Sx			x = 57 y = 174	10,5	56	60x6	370	Curva	21100412 21100413
55254 55658	Type U (29100405/6)	Dx Sx			x = 130 y = 210 z = 18	14,5	48	80x6	960	Curva	291004056
56574 56575	U nuovo tipo	Dx Sx			x = 130 y = 210 z = 18	14,5	48	80x7	1100	Curva	29100405 29100406
56576 56577	U nuovo tipo	Dx Sx			x = 130 y = 200 z = 14	14,5	48	80x7	1150	Squadro	29100407 29100408

MEAT

55052 55545	FP	Dx Sx			x = 60 y = 135	10,5	35	50x6	340	Squadro	-
55325 55331	FA Arco	Dx Sx			x = 88 y = 190	12,5	42	60x6	550	Curva	-

MERITANO

57015 57016	Tipo Pesante Arco ELic.	Dx Sx			x = 106 y = 190 z = 22	14,5	50	80x8	1050	Curva	-
57017 57018	Tipo Pesante Arco ELic.	Dx Sx			x = 106 y = 205 z = 22	14,5	50	80x8	1150	Curva	-



Zappe - Coltelli - Denti - Lame - Molle

BLADES - SPARE TINES FOR ROTARY HARROWS - CULTIVATOR SPRINGS





03

03









segue ZAPPE e COLTELLI COUTEAUX - BLADES - MESSERN - AZADILLAS y HOJAS

ARTICOLO	MODELLO	LATO	DISEGNO		MISURE x = mm y = mm z = mm	Ø FORO mm	INTERASSE mm	PIATTO mm	PESO g	FORMA	OEM
											



Segue MERITANO

57019 57020	MDV Arco ELic.	Dx Sx			x = 120 y = 210 z = 24	14,5	50	80x8	1200	Curva	-
57021 57022	TL Arco ELic.	Dx Sx			x = 115 y = 180 z = 22	14,5	50	80x7	900	Curva	-















MURATORI

55269 55268	MS3P-140-160 - MS2-100-120	Dx Sx			x = 110 y = 178	12,5	46	70x7	800	Squadro	12000700D 12000800S
55273 55804	MS2-140-160 - MS3P-180	Dx Sx			x = 113 y = 190 z = 10	14,5	46	70x7	800	Curva	-
55805 55806	MS3P	Dx Sx			x = 110 y = 190	12,5	46	60x6	680	Curva	12000101D 12000201S
55814 55815	MS3P Arco Elic. 12000500/600	Dx Sx			x = 113 y = 190 z = 10	12,5	46	70x7	800	Curva	-

NARDI

55295 55669	5C / 5012 N.T.	Dx Sx			x = 115 y = 175	12,5	55	75x7	840	Curva	-
------------------------------	----------------	----------	-------------------------------------------------------------------------------------	-------------------------------------------------------------------------------------	--------------------	------	----	------	-----	-------	---



NIBBI BRUNO - YABE

55305 55675	G 119	Dx Sx			x = 90 y = 195 z = 25	12,5	42	60x6	570	Curva	-
55306 55676	Artiglio «E» N.T. 519	Dx Sx			x = 68 y = 180	8,5	37	35x6	330	Squadro	-
55307 55677	719 N.T.	Dx Sx			x = 56 y = 160	8,5	37	30x6	250	Squadro	-
55308 55678	G 519 ultimo tipo	Dx Sx			x = 72 y = 161	8,5	42	50x5	400	Curva	-
56173 56174	G 519 ultimo tipo	Dx Sx			x = 72 y = 161	10,5	42	50x5	340	Curva	-
56971 56972	Arco	Dx Sx			x = 60 y = 197	8,5	65	30x4	160	Curva	-
56973 56974	Motocoltivatore TOP MAX 305 Arco / ELIC.	Dx Sx			x = 52 y = 170 z = 15	8,5	58	25x5	180	Curva	-





segue **ZAPPE e COLTELLI**
COUTEAUX - BLADES - MESSERN - AZADILLAS y HOJAS

ARTICOLO	MODELLO	LATO	DISEGNO	MISURE x = mm y = mm z = mm	Ø FORO mm	INTERASSE mm	PIATTO mm	PESO g	FORMA	OEM
----------	---------	------	---------	--------------------------------------	-----------------	-----------------	--------------	-----------	-------	-----









NIBBI DECIMO

55370 55373	Grifo Extra Arco	Dx Sx			x = 72 y = 167	10,5	35	50x6	400	Curva	-
------------------------------	------------------	----------	-----------------------------------------------------------------------------------	-----------------------------------------------------------------------------------	-------------------	------	----	------	-----	-------	---













OMMAS

56975 56976	FS M/5 Interfilare Arco	Dx Sx			x = 90 y = 176	12,5	41	40x8	500	Curva	-
55273 55804	140 Prestige Arco Elic.	Dx Sx			x = 113 y = 190 z = 10	14,5	46	70x7	800	Curva	-

PASBO

55315 55683	G14 - T/Grottaglie	Dx Sx			x = 80 y = 227	10,5	73	50x6	500	Curva	-
55319 55684	G72 - 83 - 84	Dx Sx			x = 80 y = 217	10,5	73	40x6	420	Curva	-
55321 55686	G51 - G2 - G62	Dx Sx			x = 65 y = 195	8,5	73	35x6	320	Curva	-
55325 55331	592 - 917 - 598	Dx Sx			x = 88 y = 190	12,5	42	60x6	550	Curva	-

PASQUALI

55327 55324	914 - 588	Dx Sx			x = 55 y = 159	10,5	32	50x6	335	Curva	-
55325 55331	592 - 917 - 598	Dx Sx			x = 88 y = 190	12,5	42	60x6	550	Curva	-
55807 55808	557	Dx Sx			x = 88 y = 162	12,5	42	60x6	450	Curva	-
55809 55810	495 - 498 - 532 - 938	Dx Sx			x = 50 y = 172	8,5	68	25x5	170	Curva	-
56955 56956	Motocoltivatore XB40-SB30 Arco Elic.	Dx Sx			x = 55 y = 193 z = 18	8,5	55	30x6	270	Curva	-
55009 55525	532 Tipo Nuovo Arco Elic.	Dx Sx			x = 75 y = 144 z = 30	10,5	40	50x6	370	Curva	-



Zappe - Coltelli - Denti - Lame - Molle

BLADES - SPARE TINES FOR ROTARY HARROWS - CULTIVATOR SPRINGS





















03

03













segue ZAPPE e COLTELLI COUTEAUX - BLADES - MESSERN - AZADILLAS y HOJAS

ARTICOLO	MODELLO	LATO	DISEGNO		MISURE x = mm y = mm z = mm	Ø FORO mm	INTERASSE mm	PIATTO mm	PESO g	FORMA	OEM
											



SEP

55362 55376	1300 - 1500 - 2000	Dx Sx			x = 55 y = 140	10,5	27	40x6	260	Curva	-
55364 55372	130 - 125	Dx Sx			x = 74 y = 217	10,5	70	45x6	450	Curva	-
55365 55369	100 - 70	Dx Sx			x = 70 y = 200	10,5	70	35x6	340	Curva	-
55366 55811	90	Dx Sx			x = 65 y = 188	8,5	70	30x6	270	Curva	-
55007 55523	1000	Dx Sx			x = 55 y = 165 z = 20	8,5	55	25x6	200	Curva	-
57023 57024	Motozappa 115 Arco	Dx Sx			x = 70 y = 195	10,5	70	45x6	400	Curva	-
57025 57026	Motozappa 140 Angolata	Dx Sx			x = 70 y = 175	10,5	35	50x6	400	Curva	-
57027 57028	Motozappa 138 Arco	Dx Sx			x = 82 y = 240	10,5	90	60x6	660	Curva	-
57029 57030	430/450 Arco Elic.	Dx Sx			x = 77 y = 211 z = 60	8,5	70	40x4	280	Curva	-
57031 57032	S/506 113 Arco Elic.	Dx Sx			x = 74 y = 215 z = 55	10,5	70	40x5	330	Curva	-



SICMA (MIGLIANICO)

57033 57034	ZLL SB Arco Elic.	Dx Sx			x = 110 y = 180 z = 10	12,5	42	60x6	600	Curva	4811281 4811282
57035 57036	SM Arco Elic.	Dx Sx			x = 135 y = 190 z = 14	14,5	55	80x7	950	Curva	4818222 4818223
57037 57038	SM Ang. Elic.	Dx Sx			x = 135 y = 190 z = 14	14,5	55	80x7	1000	Squadro	4818224 4818225
57039 57040	ST-SD-HS Arco Elic.	Dx Sx			x = 135 y = 175 z = 14	14,5	55	80x7	900	Curva	4812425 4812426
57041 57042	ST-SD-HS Ang. Elic.	Dx Sx			x = 135 y = 170 z = 14	14,5	55	80x7	970	Squadro	48124427 48124428
57043 57044	ST-SD-HS Arco Elic.	Dx Sx			x = 105 y = 160 z = 8	12,5	42	60x6	670	Squadro	4811283 4811284







segue **ZAPPE e COLTELLI**
COUTEAUX - BLADES - MESSERN - AZADILLAS y HOJAS

ARTICOLO	MODELLO	LATO	DISEGNO		MISURE x = mm y = mm z = mm	Ø FORO mm	INTERASSE mm	PIATTO mm	PESO g	FORMA	OEM
											





















SICMA (OSTRA VETERE)

55201 55620	Bronty-Ripuntatore Rompitraccia	Dx Sx			x = 140 y = 180	13	57	80x7	1070	Squadro	-
------------------------------	---------------------------------	----------	-----------------------------------------------------------------------------------	-----------------------------------------------------------------------------------	--------------------	----	----	------	------	---------	---



SOVEMA

55814 55815	SP - SPC - SE - SEC - S - SPS	Dx Sx			x = 110 y = 187 z = 7	12,5	46	70x7	780	Curva	-
55273 55804	SE - SEC - SEC3 - S (160)	Dx Sx			x = 113 y = 190 z = 10	14,5	46	70x7	800	Curva	-
55805 55806	Arco Elic.	Dx Sx			x = 110 y = 190	12,5	46	60x6	680	Curva	-

VALPADANA

55370 55373	VMC 14 - VMC 160	Dx Sx			x = 72 y = 167	10,5	35	50x6	400	Curva	-
55362 55376	VMC 8	Dx Sx			x = 55 y = 140	10,5	27	40x6	260	Curva	-
55364 55372	VMC 150	Dx Sx			x = 74 y = 217	10,5	70	45x6	450	Curva	-
55365 55369	VMC 140	Dx Sx			x = 70 y = 200	10,5	70	35x6	340	Curva	-
57045 57046	VMC 15 Arco	Dx Sx			x = 82 y = 190	10,5	35	50x6	470	Curva	-
57047 57048	MC 18-4 RM20 Arco	Dx Sx			x = 96 y = 220	10,5	45	60x6	600	Curva	-
57049 57050	VMC 10-12 Arco	Dx Sx			x = 83 y = 142	10,5	35	50x6	340	Curva	-
57051 57052	VMC 18 Nuovo Tipo Arco	Dx Sx			x = 96 y = 213	10,5	46	60x6	640	Curva	-
57053 57054	VMC 8 Angolata	Dx Sx			x = 54 y = 160	10,5	27	40x6	320	Curva	-
57055 57056	Valpadana 4RM-180 Arco	Dx Sx			x = 89 y = 185	10,5	42	60x6	560	Curva	-

ZAPPATOR

55244 55651	Interfilare Arco Elic.	Dx Sx			x = 135 y = 186 z = 14	14,5	56	80x6	850	Curva	-
------------------------------	------------------------	----------	-------------------------------------------------------------------------------------	-------------------------------------------------------------------------------------	------------------------------	------	----	------	-----	-------	---

Zappe - Coltelli - Denti - Lame - Molle

BLADES - SPARE TINES FOR ROTARY HARROWS - CULTIVATOR SPRINGS

03

BULLONI COMPLETI CON VITI A FILETTO PARZIALE CLASSE 8.8

BULLONERIE - BOLTS AND NUTS - PEZIELLE - TORNILLOS

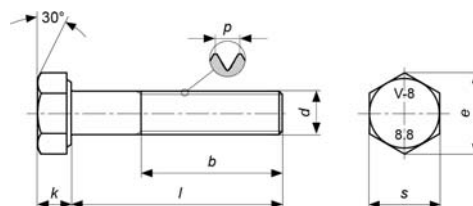
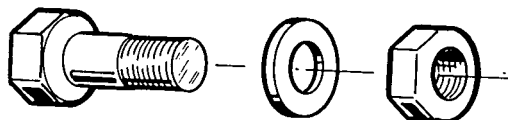











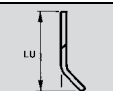

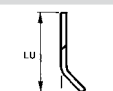

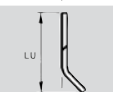

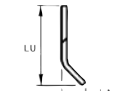

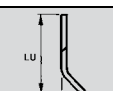

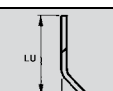

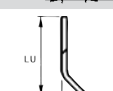

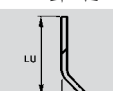

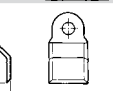
ARTICOLO	d	l mm	b mm	p mm	s mm	e min mm	k mm	TIPO ZAPPA
55460	M8	30	23	1,25	12	14,6	5,12	—
55461	M10	30	16	1,5	17	19,12	6,52	—
56175	M10	35	21	1,25	17	19,1	6,27	—
55463	M12	35	19	1,25	19	21,5	7,59	—
57600	M12	40	19	1,25	19	21,5	7,59	—
55464	M14	35	19,6	1,5	22	24,9	8,78	—
55087	M14	40	22	1,5	22	24,9	8,78	—
55173	M14	50	22	1,5	22	24,9	8,87	—
55465	M16	45	27	1,5	24	26,9	10,05	—
56407	M16	50	36	1,5	24	26,9	9,95	—
55088	10,9	31	20	1,25	16	17,7	6,97	Howard «P»
55089	12,47	37	24	1,25	19	21,5	7,83	Howard «U»

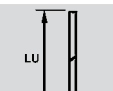

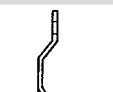
COLTELLI PER TRINCIA

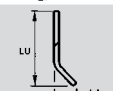
LAMES POUR DEBROUSSAILLEUSES - FORESTRY BRUSH CUTTER - SCHLEGELMESSER - CUCHILLAS PARA DESMALEZADORAS

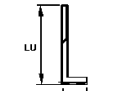
ARTICOLO	DESCRIZIONE	DISEGNO		MISURE LA = mm LU = mm	FORO mm	PIATTO mm	BOCCOLA ARTICOLO	GRILLO ARTICOLO	
									
ACMA									
56208	Coltello a Y TL leggero			LA = 42 LU = 114	14,5	35x5			
56213	coltello a Y leggero			LA = 25 LU = 80	14,5	35x5	57126		
55825	Coltello a Y TMF TMS			LA = 60 LU = 140	25,5	60x8	56584 56583 56325		
55313	Coltello a Y tipo lungo			LA = 55 LU = 205	25,5	60x10	56584		
AGRAM									
55832	Coltello a Y			LA = 47 LU = 215	29	65x7	55831		
AGRICOM									
56205	Coltello universale a Y			LA = 60 LU = 140	16,5	60x8			
55825	Coltello universale a Y			LA = 60 LU = 140	25,5	60x8	56584 56583 56325		
56206	Coltello a Y tipo corto			LA = 45 LU = 120	16,5	40x8			
56207	Coltello testa interfila a ZETA			LA = 50 LU = 240	25,5	60x8			
56307	Coltello interfila diritto			LA = LU = 225	25,5	60x8			
57116	Ruota interfila coltello rotazione SX			LA = LU = 235	25,5	-			
55828	Coltello a Y			LA = 55 LU = 204	25,5	60x8	56323		
56244	Coltello a L			LA = 55 LU = 192	25,5	60x8	56323		

Zappe - Coltelli - Denti - Lame - Molle

BLADES - SPARE TINES FOR ROTARY HARROWS - CULTIVATOR SPRINGS

03

03

segue COLTELLI PER TRINCIA

LAMES POUR DEBROUSSAILLEUSES - FORESTRY BRUSH CUTTER - SCHLEGELMESSER - CUCHILLAS PARA DESMALEZADORAS

ARTICOLO	DESCRIZIONE	DISEGNO		MISURE LA = mm LU = mm	FORO mm	PIATTO mm	BOCCOLA ARTICOLO	GRILLO ARTICOLO
56254	B659-C Coltello con asola tipo corto			LA = 40 LU = 82	30x14	40x5	56338	56342 57121 56347
56768	665-C coltello con asola dritto			LA = LU = 82	30x14	40x5		56342
56208	ELL - LM Coltello a Y			LA = 42 LU = 114	14,5	35x5		
56209	ELP - SICURA coltello a Y			LA = 47 LU = 117	20,5	40x8	57127	
56210	RMU coltello a L			LA = 50 LU = 145	25,5	60x10		
56211	RMU coltello universale a Y			LA = 55 LU = 150	25,5	60x10	56740	
56213	LM3 coltello a Y			LA = 25 LU = 80	14,5	35x5	57126	
57057	Coltello dritto			LA = LU = 150	25,5	60x10		
57058	Expert coltello Y			LA = 55 LU = 120	14,5	40x10		
56207	Coltello testa interfila a ZETA			LA = 50 LU = 240	25,5	60x8		
57116	Ruota interfila coltello rotazione SX			LA = LU = 235	25,5	-		
55310	Iron Coltello			LA = 66 LU = 245	25,5	60x8	56324	
56169	Coltello con asola Y tipo A - Green Shark			LA = 45 LU = 80	30x14	40x8	56338	56342
56766	RMU Coltello dritto tipo nuovo			LA = LU = 150	25,5	60x8	56583 56325 57132	
56343	Spatola TKA-TKB			LA = 70 LU = 80	14x25	36x7		56342

segue **COLTELLI PER TRINCIA**
LAMES POUR DEBROUSSAILLEUSES - FORESTRY BRUSH CUTTER - SCHLEGELMESSER - CUCHILLAS PARA DESMALEZADORAS

ARTICOLO	DESCRIZIONE	DISEGNO		MISURE LA = mm LU = mm	FORO mm	PIATTO mm	BOCCOLA ARTICOLO	GRILLO ARTICOLO	
AGROTEC									
56254	B659-C Coltello con asola tipo corto			LA = 40 LU = 82	30x14	40x5	56338	56342 57121 56347	
56768	665-C coltello con asola dritto			LA = LU = 82	30x14	40x5		56342	
ASSALONI									
56314	Dente			LA = 52 LU = 160 SP = 10	20,5	40x10	56316		
BCS									
56343	Spatola TKA-TKB			LA = 70 LU = 80	14x25	36x7		56342 57125	
57390	Coltello a Y 33581			LA = 36 LU = 102	12,50	30x4			
BECCHIO - BERFRALK									
56309	Coltello a Y			LA = 52 LU = 205	25,5	60x8			
55313	Coltello a Y			LA = 55 LU = 205	25,5	60x10	56584		
57059	Coltello dritto			LA = LU = 204	25,5	60x8			
57455	Coltello			LA = 52 LU = 186	26	34x8			
BERTI									
56578	Coltello Y C6010F28			LA = 50 LU = 193	29	60x8	57129 57130		
56579	Coltello DIRITTO			LU = 200	29	60x8			
56580	Coltello Y			LA = 50 LU = 205	29	60x10			
56581	Coltello LUNGO			LA = 50 LU = 205	29	60x8	57129 57130		

Zappe - Coltelli - Denti - Lame - Molle



BLADES - SPARE TINES FOR ROTARY HARROWS - CULTIVATOR SPRINGS

03



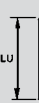

03

segue COLTELLI PER TRINCIA



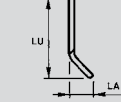

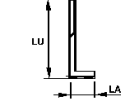
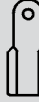
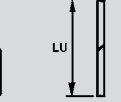
LAMES POUR DEBROUSSAILLEUSES - FORESTRY BRUSH CUTTER - SCHLEGELMESSER - CUCHILLAS PARA DESMALEZADORAS

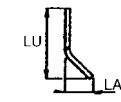
ARTICOLO	DESCRIZIONE	DISEGNO		MISURE LA = mm LU = mm	FORO mm	PIATTO mm	BOCCOLA ARTICOLO	GRILLO ARTICOLO
								



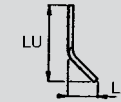

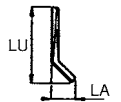

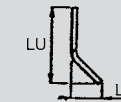

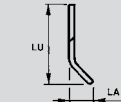

Segue BERTI

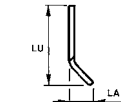
57060	EKR coltello Y			LA = 70 LU = 113	25,5	50x8		
57061	TSB coltello a L			LA = 70 LU = 198	29	60x8	57129 57130	
57062	Coltello DIRITTO			LU = 113	25,5	50x8		
55972	Coltello Y per braccio decespugliatore			LA = 40 LU = 80	26x14	40x5		56400 57125

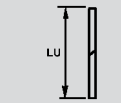
BOMFORD - TURNER

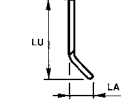

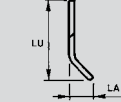

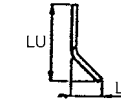





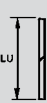

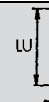



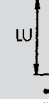



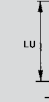



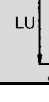

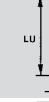

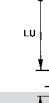
56337	5.254.22			LA = 41 LU = 101	14x26	40x5	56338	56347
56339	Universale 5.254.30			LA = 36 LU = 97	14x27	35x8	57128 56352	56347 57124
56254	B659-C Coltello con asola tipo corto			LA = 40 LU = 82	30x14	40x5	56338	56342 57121 56347

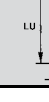
BREVIGLIERI

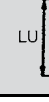
57063	Coltello a Y			LA = 65 LU = 210	25,5	60x10		
57064	Coltello Y 2079 tipo leggero per sarmenti			LA = 52 LU = 120	16,5	40x10		
57065	Coltello DIRITTO			LU = 200	25,5	60x10		
57066	T60/80/90 Coltello Y			LA = 52 LU = 110	16,5	40x10		
57067	Coltello a Y TO100031 - H80			LA = 55 LU = 182	25,5	60x10		
56254	Coltello con asola Y			LA = 40 LU = 82	30x14	40x5	56338	56342 57121 56347

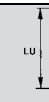
segue COLTELLI PER TRINCIA

LAMES POUR DEBROUSSAILLEUSES - FORESTRY BRUSH CUTTER - SCHLEGELMESSER - CUCHILLAS PARA DESMALEZADORAS

ARTICOLO	DESCRIZIONE	DISEGNO		MISURE LA = mm LU = mm	FORO mm	PIATTO mm	BOCCOLA ARTICOLO	GRILLO ARTICOLO	
									
BRUNI									
56314	Coltello 1/2 giro			LA = 52 LU = 160 SP = 10	20,5	40x10			
56878	Coltello 1/2 giro			LA = 60 LU = 162 SP = 10	20,5	50x10			
57471	Coltello 1/2 giro			LA = 56 LU = 167 SP = 10	27,5	50x10			
56315	Coltello taglia erba			LA = 42 LU = 150	20,5	45x5	56316		
CABE - COMAGRI									
56214	Coltello universale a Y			LA = 55 LU = 230	28,5	60x7			
56213	LM3 coltello a Y			LA = 25 LU = 80	14,5	35x5	57126		
56242	Coltello a Y con asola			LA = 40 LU = 90	30x14	40x6		56342	
CALDERONI									
56211	Coltello a Y universale MT7			LA = 55 LU = 150	25,5	60x10	56740		
56209	Coltello a Y MT5 - MT6			LA = 47 LU = 117	20,5	40x8	57127		
56213	LM3 / tipo nuovo coltello a Y			LA = 25 LU = 80	14,5	35x5	57126		
CARONI									
56254	TL-TM coltello con asola			LA = 40 LU = 82	30x14	40x5	56338	56342 57121 56347	
CELLI									
57068	Coltello a Y			LA = 55 LU = 120	16,5	50x10			
57069	Coltello dritto			LA = LU = 120	16,5	50x10			
57070	Coltello dritto			LA = LU = 115	16,5	40x8			

Zappe - Coltelli - Denti - Lame - Molle

BLADES - SPARE TINES FOR ROTARY HARROWS - CULTIVATOR SPRINGS

03



03

segue COLTELLI PER TRINCIA



LAMES POUR DEBROUSSAILLEUSES - FORESTRY BRUSH CUTTER - SCHLEGELMESSER - CUCHILLAS PARA DESMALEZADORAS

ARTICOLO	DESCRIZIONE	DISEGNO		MISURE LA = mm LU = mm	FORO mm	PIATTO mm	BOCCOLA ARTICOLO	GRILLO ARTICOLO
segue CELLI								
56206	Coltello a Y leggero			LA = 45 LU = 120	16,5	40x8		
COSMA								
56314	Dente			LA = 52 LU = 160 SP = 10	20,5	40x10	56316	
56170	Coltello con asola			LA = 40 LU = 105	30x14	40x8		56342
DRAGONE								
55313	Coltello a Y			LA = 55 LU = 205	25,5	60x10	56584	
57586	Coltello a Y tipo leggero OEM 192.02.653			LA = 41 LU = 100	16,5	40x5		
ENERGREEN BY LASERJET								
55825	Coltello Y			LA = 60 LU = 140	25,5	60x8	56584 56583 56325	
56170	Coltello con asola a Y			LA = 40 LU = 105	30x14	40x8		56342
56766	Coltello dritto			LA = LU = 150	25,5	60x8	56583 56325 57132	
FALC								
55313	ALCE coltello 01 a Y			LA = 55 LU = 205	25,5	60x10	56584	
55312	ALCE coltello 02 tipo dritto			LA = LU = 204	25,5	60x10		
57071	Trancia laterale F.P. coltello rotatore			LA = 39 LU = 98	35x17	40x12	57131	56322
FALCONERO								
56209	Coltello a Y			LA = 47 LU = 117	20,5	40x8	57127	
56213	Coltello Y per testa interfila			LA = 25 LU = 80	14,5	35x5	57126	

segue COLTELLI PER TRINCIA
LAMES POUR DEBROUSSAILLEUSES - FORESTRY BRUSH CUTTER - SCHLEGELMESSER - CUCHILLAS PARA DESMALEZADORAS

ARTICOLO	DESCRIZIONE	DISEGNO		MISURE LA = mm LU = mm	FORO mm	PIATTO mm	BOCCOLA ARTICOLO	GRILLO ARTICOLO
								

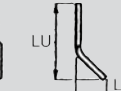

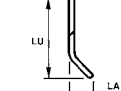



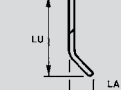





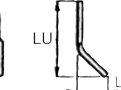

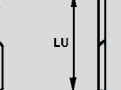

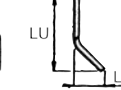

segue FALCONERO

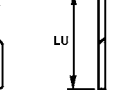
56170	Coltello con asola a Y			LA = 40 LU = 105	30x14	40x8		56342
56206	Coltello a Y			LA = 45 LU = 120	16,5	40x8		

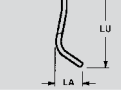
FAUSTINI

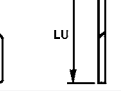
56206	Coltello a Y			LA = 45 LU = 120	16,5	40x8		
--------------	--------------	-----------------------------------------------------------------------------------	-----------------------------------------------------------------------------------	---------------------	------	------	--	--

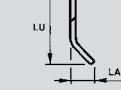
FERRI

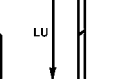
56767	Coltello a Y con asola OEM 0901068			LA = 43 LU = 100	35x17	40x8	56338	56342
56170	Coltello con asola tipo lungo			LA = 40 LU = 105	30x14	40x8		56342
56810	Coltello diritto con asola OEM 0901153			LA = LU = 104	35x17	40x6		
56169	Coltello con asola tipo corto OEM 0901209			LA = 45 LU = 80	30x14	40x8	56338	56342
55825	Coltello tipo TS e polivalente			LA = 60 LU = 140	25,5	60x8	56584 56583 56325	
56766	Coltello tipo TS diritto			LA = LU = 150	25,5	60x8	56583 56325 57132	
55310	Coltello universale F150 OEM 0901001			LA = 66 LU = 245	25,5	60x8	56324	
56218	Coltello diritto			LA = LU = 245	25,5	60x8		
56220	Coltello polivalente leggero			LA = 55 LU = 130	16,5	40x8		
56307	Coltello testa interfila tipo diritto			LA = LU = 225	25,5	60x8		

Zappe - Coltelli - Denti - Lame - Molle

BLADES - SPARE TINES FOR ROTARY HARROWS - CULTIVATOR SPRINGS

03



03

segue COLTELLI PER TRINCIA

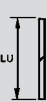

LAMES POUR DEBROUSSAILLEUSES - FORESTRY BRUSH CUTTER - SCHLEGELMESSER - CUCHILLAS PARA DESMALEZADORAS

ARTICOLO	DESCRIZIONE	DISEGNO		MISURE LA = mm LU = mm	FORO mm	PIATTO mm	BOCCOLA ARTICOLO	GRILLO ARTICOLO
56221	Coltello MC18 corto OEM 0901085			LA = 45 LU = 122	25,5	60x8		
56222	Coltello MC18 lungo OEM 0901086			LA = 65 LU = 125	25,5	60x8		
57071	Spatola con asola			LA = 39 LU = 98	35x17	40x12	57131	56322
57115	Coltello Y tipo lungo OEM 0901004			LA = 65 LU = 237	25,5	60x8		
57073	Coltello Y polivalente tip. OEM 0901146			LA = 40 LU = 130	16,5	50x8		
57074	Coltello con asola stampato OEM 0901049			LA = 44 LU = 80	27x14	40x8		
57075	Coltello Y tipo nuovo OEM 0901003			LA = 50 LU = 144	25,5	60x8	56584 56325	
57076	Coltello Y OEM 0901158			LA = 40 LU = 130	12,5	40x6		
57077	Coltello diritto OEM 0901159			LA = LU = 130	12,5	40x6		
57078	Coltello con asola OEM 0901160			LA = 42 LU = 82	30x14	40x6		
57079	Coltello diritto con asola OEM 0901161			LA = LU = 82	30x14	40x6		
55972	Coltello Y con asola OEM 0901133			LA = 40 LU = 80	26x14	40x5		56400 57125
57080	Coltello diritto TIG OEM 0901149			LA = LU = 130	16,5	40x8		
56343	Spatola OEM 0901072			LA = 70 LU = 80	14x25	36x7		56342





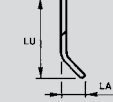

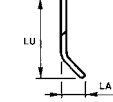



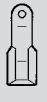
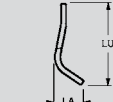

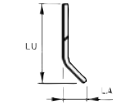

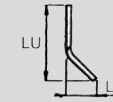
segue **COLTELLI PER TRINCIA**
LAMES POUR DEBROUSSAILLEUSES - FORESTRY BRUSH CUTTER - SCHLEGELMESSER - CUCHILLAS PARA DESMALEZADORAS

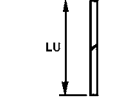
ARTICOLO	DESCRIZIONE	DISEGNO		MISURE LA = mm LU = mm	FORO mm	PIATTO mm	BOCCOLA ARTICOLO	GRILLO ARTICOLO
								

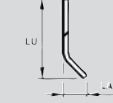

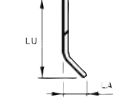

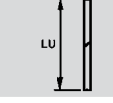

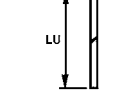
FORIGO - ROTERITALIA

56209	Coltello a Y			LA = 47 LU = 117	20,5	40x8	57127	
56214	Coltello a Y			LA = 55 LU = 230	28,5	60x7		

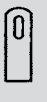
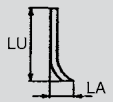
FRONTONI

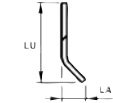
55310	Coltello universale			LA = 66 LU = 245	25,5	60x8	56324	
55825	Coltello Y			LA = 60 LU = 140	25,5	60x8	56584 56583 56325	
56169	Coltello con asola			LA = 45 LU = 80	30x14	40x8	56338	56342
56766	Coltello dritto 0901148			LA = LU = 150	25,5	60x8	56583 56325 57132	
55313	Coltello a Y			LA = 55 LU = 205	25,5	60x10	56584	
56234	Coltello a Y			LA = 40 LU = 135	16,5	40x8		
57080	Coltello dritto			LA = LU = 130	16,5	40x8		
56768	Coltello con asola dritto			LA = LU = 82	30x14	40x5		56342

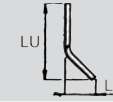
GL 1

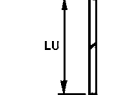
57071	Coltello spatola			LA = 39 LU = 98	35x17	40x12	57131	56322
55825	Coltello Y			LA = 60 LU = 140	25,5	60x8	56584 56583 56325	
56169	Coltello con asola			LA = 45 LU = 80	30x14	40x8	56338	56342
56766	Coltello dritto			LA = LU = 150	25,5	60x8	56583 56325 57132	

Zappe - Coltelli - Denti - Lame - Molle

BLADES - SPARE TINES FOR ROTARY HARROWS - CULTIVATOR SPRINGS

03

03

segue COLTELLI PER TRINCIA

LAMES POUR DEBROUSSAILLEUSES - FORESTRY BRUSH CUTTER - SCHLEGELMESSER - CUCHILLAS PARA DESMALEZADORAS

ARTICOLO	DESCRIZIONE	DISEGNO		MISURE LA = mm LU = mm	FORO mm	PIATTO mm	BOCCOLA ARTICOLO	GRILLO ARTICOLO

segue GL 1

56234	Coltello a Y		LA = 40 LU = 135	16,5	40x8			
--------------	--------------	--	---------------------	------	------	--	--	--

GREENTECH

56169	Coltello con asola		LA = 45 LU = 80	30x14	40x8	56338	56342
57081	Coltello dritto		LA = LU = 114	14,5	35x5		
56234	Coltello a Y		LA = 40 LU = 135	16,5	40x8		
57080	Coltello diritto		LA = LU = 130	16,5	40x8		
56768	Coltello con asola dritto		LA = LU = 82	30x14	40x5		56342

HMF FREI

56254	Coltello a Y con asola		LA = 40 LU = 82	30x14	40x5	56338	56342 57121 56347
--------------	------------------------	--	--------------------	-------	------	-------	-------------------------

HYMACH

56215	Coltello con asola		LA = 44 LU = 113	30x14	40x8		
56216	Coltello a Y		LA = 42 LU = 152	20,5	50x8		
56217	Coltello con asola diritto		LA = LU = 113	35x17	40x6		
56224	Dente girato		LA = LU = 160 SP =	20,5	50x12		

segue COLTELLI PER TRINCIA
LAMES POUR DEBROUSSAILLEUSES - FORESTRY BRUSH CUTTER - SCHLEGELMESSER - CUCHILLAS PARA DESMALEZADORAS

ARTICOLO	DESCRIZIONE	DISEGNO		MISURE LA = mm LU = mm	FORO mm	PIATTO mm	BOCCOLA ARTICOLO	GRILLO ARTICOLO
55312	Coltello diritto OEM 6060002			LA = LU = 204	25,5	60x10		
55313	Coltello a Y OEM 6060004			LA = 55 LU = 205	25,5	60x10	56584	
56236	Coltello a Y BNA OEM 6060009			LA = 50 LU = 130	20,5	50x10		
56234	Coltello a Y BNE OEM 6060000			LA = 40 LU = 135	16,5	40x8		
57082	Spatola c/occhiello OEM 6060842 - 6060179			LA = x LU = x	25,5	34x8		

KVERNELAND - MALETTI

55971	Coltello a Y universale FM - FH			LA = 40 LU = 130	14,5	40x5		
55972	Coltello per sassi - con asola FM - FH			LA = 40 LU = 80	26x14	40x5		56400 57125
57083	FX coltello a Y OEM 6400080			LA = 57 LU = 194	16,5	50x10		
57084	FX coltello diritto			LA = LU = 200	16,5	50x10		
57085	Coltello a Y			LA = 42 LU = 130	16,5	40x10		
57086	FH coltello a Y pesante			LA = 42 LU = 130	14,5	40x10		
57087	Coltello a Y			LA = 50 LU = 130	16,5	40x10		

MASCHIO

56251	Coltello a Y tipo corto			LA = 70 LU = 115	20,5	60x10		
--------------	----------------------------	--	--	---------------------	------	-------	--	--

Zappe - Coltelli - Denti - Lame - Molle











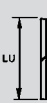

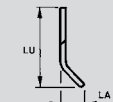

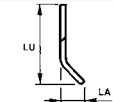

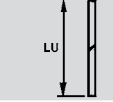

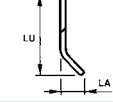

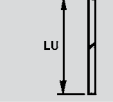

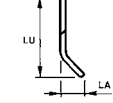
BLADES - SPARE TINES FOR ROTARY HARROWS - CULTIVATOR SPRINGS

03

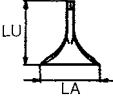

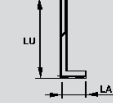
03

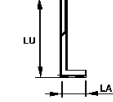
segue COLTELLI PER TRINCIA

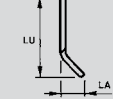
LAMES POUR DEBROUSSAILLEUSES - FORESTRY BRUSH CUTTER - SCHLEGELMESSER - CUCHILLAS PARA DESMALEZADORAS

ARTICOLO	DESCRIZIONE	DISEGNO		MISURE LA = mm LU = mm	FORO mm	PIATTO mm	BOCCOLA ARTICOLO	GRILLO ARTICOLO
								
56252	Coltello a Y tipo lungo			LA = 55 LU = 150	20,5	60x10		
56588	Coltello a Y tipo pesante			LA = 61 LU = 210	25,5	60x8		
55165	Coltello dritto tipo pesante			LA = LU = 210	25,5	60x8		
56589	Coltello a Y tipo leggero			LA = 56 LU = 125	16,5	45x8		
57117	Vita coltello dritto tipo leggero			LA = LU = 135	16,5	45x8		
57088	Bisonte Giraffa coltello a Y			LA = 60 LU = 115	20,5	50x10		
56254	Coltello con asola			LA = 40 LU = 82	30x14	40x5	56338	56342 57121 56347
56343	Spatola BA			LA = 70 LU = 80	14x25	36x7		56342
57089	Coltello L tipo leggero			LA = 60 LU = 135	16,5	45x8		
57090	Coltello L tipo pesante			LA = 60 LU = 210	25,5	60x8		
57091	Coltello Y tipo leggero			LA = 57 LU = 180	20,5	50x10		

MEAT - MEARELLI

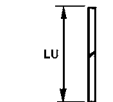
55313	Coltello a Y per trincia			LA = 55 LU = 205	25,5	60x10	56584	
55312	Coltello per trincia tipo dritto			LA = LU = 204	25,5	60x10		

segue COLTELLI PER TRINCIA
LAMES POUR DEBROUSSAILLEUSES - FORESTRY BRUSH CUTTER - SCHLEGELMESSER - CUCHILLAS PARA DESMALEZADORAS

ARTICOLO	DESCRIZIONE	DISEGNO		MISURE LA = mm LU = mm	FORO mm	PIATTO mm	BOCCOLA ARTICOLO	GRILLO ARTICOLO

segue MEAAT - MEARELLI

56230	Coltello a L per trincia			LA = 50 LU = 199	25,5	60x10		
55972	Coltello Y per braccio decespugliatore			LA = 40 LU = 80	26x14	40x5		

MORIS

56169	Coltello con asola tipo corto			LA = 45 LU = 80	30x14	40x8	56338	56342
57081	Coltello diritto			LA = LU = 114	14,5	35x5		
56234	Coltello a Y			LA = 40 LU = 135	16,5	40x8		
57080	Coltello diritto TIG OEM 0901149			LA = LU = 130	16,5	40x8		
56768	665-C coltello con asola dritto			LA = LU = 82	30x14	40x5		56342

MURATORI

56208	Coltello a Y MT.2			LA = 42 LU = 114	14,5	35x5		
56209	Coltello a Y MT5 - MT6			LA = 47 LU = 117	20,5	40x8	57127	
56211	Coltello a Y universale MT7			LA = 55 LU = 150	25,5	60x10	56740	
57081	Coltello diritto			LA = LU = 114	14,5	35x5		
56343	Spatola			LA = 70 LU = 80	14x25	36x7		56342

NICOLAS

56337	Coltello con asola			LA = 41 LU = 101	14x26	40x5	56338	56347
--------------	--------------------	--	--	---------------------	-------	------	-------	-------

Zappe - Coltelli - Denti - Lame - Molle

BLADES - SPARE TINES FOR ROTARY HARROWS - CULTIVATOR SPRINGS

03

03

segue COLTELLI PER TRINCIA

LAMES POUR DEBROUSSAILLEUSES - FORESTRY BRUSH CUTTER - SCHLEGELMESSER - CUCHILLAS PARA DESMALEZADORAS

ARTICOLO	DESCRIZIONE	DISEGNO		MISURE LA = mm LU = mm	FORO mm	PIATTO mm	BOCCOLA ARTICOLO	GRILLO ARTICOLO
56234	Coltello a Y BNE 100 - 180			LA = 40 LU = 135	16,5	40x8		
56236	Coltello a Y BNA			LA = 50 LU = 130	20,5	50x10		
55310	Coltello a Y TRITURATOR RM			LA = 66 LU = 245	25,5	60x8		
55312	Coltello diritto 02 - BMG OEM 1551000			LA = LU = 204	25,5	60x10		
55313	Coltello a Y BMG OEM 2555004			LA = 55 LU = 205	25,5	60x10		
56230	Coltello a 90° BMG			LA = 50 LU = 199	25,5	60x10		
56237	Coltello a Y con asola			LA = 40 LU = 90	30x14	35x7		
57092	BB - B10 - B12 coltello Y 17496			LA = 40 LU = 178	16,5	40x8		
57080	BNE coltello diritto			LA = LU = 130	16,5	40x8		
57082	Spatola c/occhiello OEM 1551128 - 1551147			LA = x LU = x	25,5	34x8		
56589	WKD 210 coltello a Y OEM 1891018			LA = 56 LU = 125	16,5	45x8		
57094	Coltello ruota interfila 20003			LA = LU = 240	16,5	40x8		
56910	WKD coltello dritto			LA = LU = 130	16,5	45x8		
57455	Coltello			LA = 52 LU = 186	26	34x8		

segue **COLTELLI PER TRINCIA**
LAMES POUR DEBROUSSAILLEUSES - FORESTRY BRUSH CUTTER - SCHLEGELMESSER - CUCHILLAS PARA DESMALEZADORAS

ARTICOLO	DESCRIZIONE	DISEGNO	MISURE LA = mm LU = mm	FORO mm	PIATTO mm	BOCCOLA ARTICOLO	GRILLO ARTICOLO
----------	-------------	---------	------------------------------	------------	--------------	---------------------	--------------------

NOREMAT

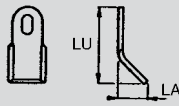
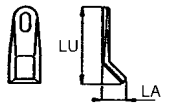
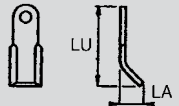
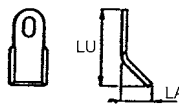
56337	Coltello con asola Y		LA = 41 LU = 101	14x26	40x5	56338	56347
56339	Coltello a Y		LA = 36 LU = 97	14x27	35x8	57128 56352	56347 57132
56336	Coltello Y		LA = 40 LU = 134	14,5	40x5		
56254	Coltello a Y con asola		LA = 40 LU = 82	30x14	40x5	56338	56342 57121 56347

OMARV

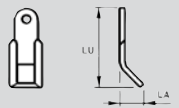
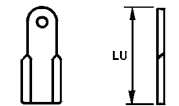
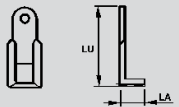
55313	Coltello a Y		LA = 55 LU = 205	25,5	60x10	56584	
55312	Coltello diritto		LA = LU = 204	25,5	60x10		
56230	Trincia		LA = 50 LU = 199	25,5	60x10		

Zappe - Coltelli - Denti - Lame - Molle

BLADES - SPARE TINES FOR ROTARY HARROWS - CULTIVATOR SPRINGS

03

03



























segue COLTELLI PER TRINCIA

LAMES POUR DEBROUSSAILLEUSES - FORESTRY BRUSH CUTTER - SCHLEGELMESSER - CUCHILLAS PARA DESMALEZADORAS

ARTICOLO	DESCRIZIONE	DISEGNO		MISURE LA = mm LU = mm	FORO mm	PIATTO mm	BOCCOLA ARTICOLO	GRILLO ARTICOLO
56234	Coltello a Y OEM 00023000			LA = 40 LU = 135	16,5	40x8		
56205	Coltello a Y OEM 00023002			LA = 60 LU = 140	16,5	60x8		
56170	Coltello a Y con asola OEM 00023001			LA = 40 LU = 105	30x14	40x8		56342
56810	Coltello diritto con asola			LA = LU = 104	35x17	40x6		
56209	Coltello a Y KL - KP OEM 00023004			LA = 47 LU = 117	20,5	40x8		
56765	Coltello 1/2 giro OEM 00023044			LA = 60 LU = 147	25,5	50x10	57297	
56769	RIVER 500 Coltello a Y OEM 00023024			LA = 40 LU = 150	20,5	40x8		
56213	Coltello Y tipo leggero OEM 00023013			LA = 25 LU = 80	14,5	35x5	57126	
57096	Coltello stampato Y OEM 00023043			LA = 40 LU = 150	25,5	60x8		
57097	Coltello con asola corto			LA = 40 LU = 95	35x17	40x8		
57098	Coltello Universale OEM 30026038			LA = 90 LU = 225	16,5	60x8		
56402	Coltello Universale OEM 30027218			LA = 92 LU = 220	25,5	60x8		
57099	Coltello diritto			LA = LU = 140	16,5	60x8		
55828	Coltello a Y OEM 00023057			LA = 55 LU = 204	25,5	60x8	56323	
56197	Modello forgiato OEM 00023056			LA = 40 LU = 99	16x39	45x8	57128 56338	56812 57123

segue COLTELLI PER TRINCIA

LAMES POUR DEBROUSSAILLEUSES - FORESTRY BRUSH CUTTER - SCHLEGELMESSER - CUCHILLAS PARA DESMALEZADORAS

ARTICOLO	DESCRIZIONE	DISEGNO		MISURE LA = mm LU = mm	FORO mm	PIATTO mm	BOCCOLA ARTICOLO	GRILLO ARTICOLO
								
PALLADINO								
56309	Coltello a Y			LA = 52 LU = 205	25,5	60x8		
57059	Coltello dritto			LA = LU = 204	25,5	60x8		
56226	Coltello a Y tipo leggero TSLL			LA = 44 LU = 100	12,5	40x5		
PEGORARO (FORT-PEGORARO)								
56309	Coltello Y 9119			LA = 52 LU = 205	25,5	60x8		
57059	Coltello dritto 9118			LA = LU = 204	25,5	60x8		
PERUGINI CONCEPT								
55825	Coltello tipo Y GT - MT			LA = 60 LU = 140	25,5	60x8	56584 56583 56325	
56206	Coltello a Y			LA = 45 LU = 120	16,5	40x8		
55313	Coltello a Y pesante			LA = 55 LU = 205	25,5	60x10	56584	
57455	Coltello			LA = 52 LU = 186	26	34x8		
PERUZZO								
56402	Coltello Universale			LA = 92 LU = 220	25,4	60x8		
57100	Coltello con asola Y			LA = 26 LU = 103	30x14	30x4		
PRE.FER.								
55825	Coltello tipo Y Standard			LA = 60 LU = 140	25,5	60x8	56584 56583 56325	

Zappe - Coltelli - Denti - Lame - Molle

BLADES - SPARE TINES FOR ROTARY HARROWS - CULTIVATOR SPRINGS

03

03

segue COLTELLI PER TRINCIA

LAMES POUR DEBROUSSAILLEUSES - FORESTRY BRUSH CUTTER - SCHLEGELMESSER - CUCHILLAS PARA DESMALEZADORAS

ARTICOLO	DESCRIZIONE	DISEGNO		MISURE LA = mm LU = mm	FORO mm	PIATTO mm	BOCCOLA ARTICOLO	GRILLO ARTICOLO
PROCOMAS								
56334	Coltello a Y			LA = 48 LU = 125	16,5	40x6		
56333	Coltello a Y			LA = 55 LU = 140	25,5	60x6	56335	
55825	Coltello Y			LA = 60 LU = 140	25,5	60x8	56584 56583 56325	
QUIVOGNE								
55312	Coltello diritto			LA = LU = 204	25,5	60x10		
55313	Coltello a Y 1052/91			LA = 55 LU = 205	25,5	60x10	56584	
56230	Coltello a L 1321/94			LA = 50 LU = 199	25,5	60x10		
56309	Coltello a Y			LA = 52 LU = 205	25,5	60x8		
RINIERI								
56213	Coltello Y tipo leggero			LA = 25 LU = 80	14,5	35x5	57126	
55825	Coltello Y			LA = 60 LU = 140	25,5	60x8	56584 56583 56325	
ROUSSEAU								
56336	Fleu-Courbe 5.254.02			LA = 40 LU = 134	14,5	40x5		
56337	5.254.22			LA = 41 LU = 101	14x26	40x5	56338	56347
56339	Universale 5.254.30			LA = 36 LU = 97	14x27	35x8	57128 56352	56347 57123
56197	Modello forgiato			LA = 40 LU = 99	16x39	45x8	57128 56338	56812 57123

segue COLTELLI PER TRINCIA
LAMES POUR DEBROUSSAILLEUSES - FORESTRY BRUSH CUTTER - SCHLEGELMESSER - CUCHILLAS PARA DESMALEZADORAS

ARTICOLO	DESCRIZIONE	DISEGNO		MISURE LA = mm LU = mm	FORO mm	PIATTO mm	BOCCOLA ARTICOLO	GRILLO ARTICOLO

SANDRI - C.M.S.

55825	Coltello Y			LA = 60 LU = 140	25,5	60x8	56584 56583 56325	
56170	Coltello con asola			LA = 40 LU = 105	30x14	40x8		56342
56766	Coltello dritto			LA = LU = 150	25,5	60x8	56583 56325 57132	

SEKO

57101	Coltello Y			LA = 50 LU = 207	25,5	60x7		
57102	Coltello dritto			LA = LU = 207	25,5	60x7		

SEPPI

57103	Coltello tipo Y Standard			LA = 33 LU = 85	30x20	45x6		
--------------	--------------------------	--	--	--------------------	-------	------	--	--

SICMA

57104	Coltello a L tipo corto			LA = 70 LU = 120	25,5	60x8		
57105	Coltello dritto			LA = LU = 197	25,5	60x8		
57106	Sicma Dente			LA = LU = 195	25,5	50x8		
57107	Coltello dritto			LA = LU = 136	16,5	40x6		

SICMA (MIGLIANICO)

56244	Coltello a L			LA = 55 LU = 192	25,5	60x8		
56227	Coltello a Y TLX			LA = 50 LU = 110	16,5	40x8		

Zappe - Coltelli - Denti - Lame - Molle

BLADES - SPARE TINES FOR ROTARY HARROWS - CULTIVATOR SPRINGS

03

03

segue COLTELLI PER TRINCIA

LAMES POUR DEBROUSSAILLEUSES - FORESTRY BRUSH CUTTER - SCHLEGELMESSER - CUCHILLAS PARA DESMALEZADORAS

ARTICOLO	DESCRIZIONE	DISEGNO		MISURE LA = mm LU = mm	FORO mm	PIATTO mm	BOCCOLA ARTICOLO	GRILLO ARTICOLO
56228	Coltello a Y TVF			LA = 50 LU = 110	20,5	40x10		
55313	Coltello a Y TRP			LA = 55 LU = 205	25,5	60x10		
56211	Coltello a Y TRG			LA = 55 LU = 150	25,5	60x10	56740	
56213	Coltello a Y TA			LA = 25 LU = 80	14,5	35x5	57126	
57057	TRG Coltello dritto			LA = LU = 150	25,5	60x10		
55828	Coltello a Y TRP			LA = 55 LU = 204	25,5	60x8	56323	

SICMA (OSTRA VETERE)

56589	Coltello a Y			LA = 56 LU = 125	16,5	45x8		
--------------	--------------	--	--	---------------------	------	------	--	--

SMA

56337	BG59 - BGC corto			LA = 41 LU = 101	14x26	40x5	56338	56347
56336	LAU			LA = 40 LU = 134	14,5	40x5		
56349	T 59 stampato			LA = 33 LU = 97	14x26	40x8		
56254	B659-C Coltello con asola tipo corto			LA = 40 LU = 82	30x14	40x5		
56768	665-C coltello con asola dritto			LA = LU = 82	30x14	40x5		
56339	Coltello a Y			LA = 36 LU = 97	14x27	35x8	57128 56352	56347 57123

segue COLTELLI PER TRINCIA
LAMES POUR DEBROUSSAILLEUSES - FORESTRY BRUSH CUTTER - SCHLEGELMESSER - CUCHILLAS PARA DESMALEZADORAS

ARTICOLO	DESCRIZIONE	DISEGNO		MISURE LA = mm LU = mm	FORO mm	PIATTO mm	BOCCOLA ARTICOLO	GRILLO ARTICOLO
56197	Universale			LA = 40 LU = 99	16x39	45x8	57128 56338	56812 57123
57108	Coltello stampato Y OEM SME6			LA = 92 LU = 95	32x15	40x6	56338	56347

SOVEMA

55828	Coltello a Y universale			LA = 55 LU = 204	25,5	60x8		
56242	Coltello a Y con asola			LA = 40 LU = 90	30x14	40x6		56342
56244	Coltelli a 90° tipo lungo			LA = 55 LU = 192	25,5	60x8		
56246	Coltello a 90° tipo corto			LA = 70 LU = 120	16,5	50x10		
56247	Coltello a Y tipo corto			LA = 70 LU = 125	16,5	50x10		
56343	Coltello spatola			LA = 70 LU = 80	14x25	36x7		56342
57107	Coltello dritto			LA = LU = 136	16,5	60x6		

TAARUP

55832	Coltello a Y 50 - 507 - 000			LA = 47 LU = 215	29	65x7		
55829	Coltello a Y PATENT 40.882-300			LA = 42 LU = 148	14	75x7		

Zappe - Coltelli - Denti - Lame - Molle











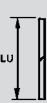

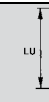



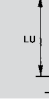



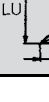

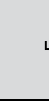

BLADES - SPARE TINES FOR ROTARY HARROWS - CULTIVATOR SPRINGS

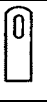
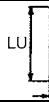
03

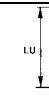
03

segue COLTELLI PER TRINCIA

LAMES POUR DEBROUSSAILLEUSES - FORESTRY BRUSH CUTTER - SCHLEGELMESSER - CUCHILLAS PARA DESMALEZADORAS

ARTICOLO	DESCRIZIONE	DISEGNO		MISURE LA = mm LU = mm	FORO mm	PIATTO mm	BOCCOLA ARTICOLO	GRILLO ARTICOLO
								
TERRANOVA								
56588	Coltello a Y tipo pesante			LA = 61 LU = 210	25,5	60x8		
55165	Coltello dritto tipo pesante			LA = LU = 210	25,5	60x8		
56589	Coltello a Y tipo leggero			LA = 56 LU = 125	16,5	45x8		
57117	Coltello dritto tipo leggero			LA = LU = 135	16,5	45x8		
56343	Spatola			LA = 70 LU = 80	14x25	36x7		56342
TIERRE								
56211	Coltello a Y			LA = 55 LU = 150	25,5	60x10	56740	
57057	Coltello dritto			LA = LU = 150	25,5	60x10		
TORTELLA								
56589	Coltello a Y			LA = 56 LU = 125	16,5	45x8		
TURNER								
56404	Coltello snodato			LA = 34 LU = 98	14x30	35x10		
UBALDI								
56213	Coltello Y			LA = 25 LU = 80	14,5	35x5	57126	
55825	Coltello Y			LA = 60 LU = 140	25,5	60x8	56584 56583 56325	
56766	Coltello dritto			LA = LU = 150	25,5	60x8	56583 56325 57132	
55313	Coltello a Y per trincia			LA = 55 LU = 205	25,5	60x10	56584	

segue COLTELLI PER TRINCIA
LAMES POUR DEBROUSSAILLEUSES - FORESTRY BRUSH CUTTER - SCHLEGELMESSER - CUCHILLAS PARA DESMALEZADORAS

ARTICOLO	DESCRIZIONE	DISEGNO		MISURE LA = mm LU = mm	FORO mm	PIATTO mm	BOCCOLA ARTICOLO	GRILLO ARTICOLO

segue UBALDI

56234	Coltello a Y			LA = 40 LU = 135	16,5	40x8		
57109	Coltello a Y tipo leggero			LA = 58 LU = 176	25,5	60x10		
57110	Coltello Y leggero			LA = 50 LU = 145	20,5	50x8		
57111	Coltello dritto leggero			LA = LU = 145	20,5	50x8		

VIGOLO

57394	Coltello curvo			LA = 74 LU = 200	25,5	60x8		
55310	Coltello universale F150			LA = 66 LU = 245	25,5	60x8		
55972	Coltello con asola			LA = 40 LU = 80	26x14	40x5		56400 57125

VOTEX

56404	Coltello snodato			LA = 34 LU = 98	14x30	35x10		56351
--------------	------------------	--	--	--------------------	-------	-------	--	-------

ZAMPINI

55825	Coltello Y			LA = 60 LU = 140	25,5	60x8	56584 56583 56325	
56169	Coltello con asola			LA = 45 LU = 80	30x14	40x8	56338	56342
56234	Coltello a Y			LA = 40 LU = 135	16,5	40x8		
56254	Coltello a Y con asola			LA = 40 LU = 82	30x14	40x5	56338	56347 57121 56342
56768	Coltello con asola dritto			LA = LU = 82	30x14	40x5		56342

Zappe - Coltelli - Denti - Lame - Molle

BLADES - SPARE TINES FOR ROTARY HARROWS - CULTIVATOR SPRINGS

03

03

segue COLTELLI PER TRINCIA

LAMES POUR DEBROUSSAILLEUSES - FORESTRY BRUSH CUTTER - SCHLEGELMESSER - CUCHILLAS PARA DESMALEZADORAS

ARTICOLO	DESCRIZIONE	DISEGNO		MISURE LA = mm LU = mm	FORO mm	PIATTO mm	BOCCOLA ARTICOLO	GRILLO ARTICOLO
56209	Coltello universale			LA = 47 LU = 117	20,5	40x8	57127	
56169	Coltello con asola			LA = 45 LU = 80	30x14	40x8	56338	56342
ZAPPATOR								
56251	Coltello a Y tipo corto			LA = 70 LU = 115	20,5	60x10		
56252	Coltello a Y tipo lungo			LA = 55 LU = 150	20,5	60x10		
56254	Coltello a Y con asola			LA = 40 LU = 82	30x14	40x5	56338	56347 57121 56342
56404	Coltello snodato			LA = 34 LU = 98	14x30	35x10		
57091	TL coltello Y tipo leggero			LA = 57 LU = 180	20,5	50x10		
57112	Coltello dritto			LA = LU = 120	20,5	60x10		
57113	Coltello Y tipo leggero			LA = 40 LU = 98	10,5	35x4		
57114	H00TC coltello Y			LA = 41 LU = 102	14,5	40x6		

BULLONI COMPLETI PER COLTELLI TRINCIA CLASSE 10.9

BOULONS COMPLETS POUR COUTEAUX HACHEUSE EN 10.9

COMPLETE BOLTS FOR CUTTER-KNIVES IN 10.9

BOLZEN FÜR MESSER DES GESTRÜPPSCHNEIDERS IN 10.9

PERNOS COMPLETOS POR CUCHILLAS TRINCHA EN 10.9



ARTICOLO	MISURA	A mm	B mm	APPLICAZIONE
56592	M12x1,75	55	19	BRUNI 1° tipo
57622	M12x1,75	60	19	-
56593	M12x1,75	65	19	BRUNI 2° tipo
56594	M12x1,75	90	19	FERRI
57623	M12x1,75	100	19	-
56199	7/16" (11,1)	84	16	ROUSSEAU-SMA-FERRI-MALETTI
56595	7/16" (11,1)	62	16	ZAPPATOR-ROUSSEAU-SMA-FERRI
57625	7/16" (11,1)	95	16	-
57319	M14x2	60	22	-
57624	M14x2	90	22	-
56602	M16x1,5	90	24	-
56564	M16x1,5	100	24	-
56603	M16x1,5	130	24	-
57223	M18x1,5	100	27	-
57444	M18x1,5	120	27	per mazza 57315
57224	M20x1,5	100	30	-
57627	M20x1,5	110	30	-
57628	M20x1,5	120	30	-
57225	M20x1,5	130	30	-
57629	M20x1,5	140	30	-
56596	M16x2	60	24	ORSI
56597	M16x2	75	24	FERRI
57388	M16x2	90	27	-
57389	M16x2	100	27	-
57626	M16x2	130	27	-

BOCCOLE

ARTICOLO	DESCRIZIONE			
57126	Boccola			Ø INTERNO = 8,2 mm Ø ESTERNO = 14 mm ALTEZZA = 28,8 mm
56740	Boccola			Ø INTERNO = 16,5 mm Ø ESTERNO = 25 mm ALTEZZA = 48,5 mm
57127	Boccola			Ø INTERNO = 14,5 mm Ø ESTERNO = 20 mm ALTEZZA = 18 mm
57128	Boccola			Ø INTERNO = 16,5 mm Ø ESTERNO = 24 mm ALTEZZA = 21 mm
56316	Boccola			Ø INTERNO = 12 mm Ø ESTERNO = 20,2 mm ALTEZZA = 12 mm
57129	Boccola			Ø INTERNO = 28 mm Ø ESTERNO = 50 mm ALTEZZA = 10 mm
57130	Boccola			Ø INTERNO = 20,5 mm Ø ESTERNO = 28 mm ALTEZZA = 40 mm
57131	Boccola			Ø INTERNO = 14,5 mm Ø ESTERNO = 25 mm ALTEZZA = 23 mm
56584	Boccola			Ø INTERNO = 25,3 mm Ø ESTERNO = 51 mm ALTEZZA = 13,4 mm
56323	Boccola			Ø INTERNO = 17 mm Ø ESTERNO = 25 mm ALTEZZA = 19 mm
56583	Boccola			Ø INTERNO = 13 mm Ø ESTERNO = 25 mm ALTEZZA = 63 mm
56587	Rondella			Ø INTERNO = 13 mm Ø ESTERNO = 35 mm ALTEZZA = 8 mm
56586	Distanziale alto			Ø INTERNO = 25,5 mm Ø ESTERNO = 40 mm ALTEZZA = 27 mm
56324	Boccola			Ø INTERNO = 17 mm Ø ESTERNO = 25 mm ALTEZZA = 28 mm
56325	Boccola			Ø INTERNO = 17 mm Ø ESTERNO = 25 mm ALTEZZA = 44 mm
56338	Distanziale			Ø INTERNO = 12,2 mm Ø ESTERNO = 20 mm ALTEZZA = 22 mm
57132	Distanziale			Ø INTERNO = 25,3 mm Ø ESTERNO = 51 mm ALTEZZA = 9,4 mm























Zappe - Coltelli - Denti - Lame - Molle

BLADES - SPARE TINES FOR ROTARY HARROWS - CULTIVATOR SPRINGS



03

03



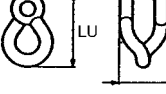

segue BOCCOLE

ARTICOLO	DESCRIZIONE				
56590	Boccola			Ø INTERNO = 25,5 mm Ø ESTERNO = 35 mm ALTEZZA = 54 mm	
56335	Boccola			Ø INTERNO = 17 mm Ø ESTERNO = 25 mm ALTEZZA = 13 mm	
56352	Distanziale			Ø INTERNO = 12,5 mm Ø ESTERNO = 20 mm ALTEZZA = 26 mm	
55831	Boccola			Ø INTERNO = 20,5 mm Ø ESTERNO = 28 mm ALTEZZA = 39 mm	
56319	Boccola			Ø INTERNO = 12,5 mm Ø ESTERNO = 20 mm ALTEZZA = 16 mm	
56582	Rondella			Ø INTERNO = 20,2 mm Ø ESTERNO = 30 mm ALTEZZA = 6 mm	
56350	Distanziale			Ø INTERNO = 29 mm Ø ESTERNO = 35 mm ALTEZZA = 13 mm	
56585	Distanziale basso			Ø INTERNO = 25,5 mm Ø ESTERNO = 40 mm ALTEZZA = 14 mm	
57297	Boccola			Ø INTERNO = 14,5 mm Ø ESTERNO = 25 mm ALTEZZA = 54 mm	OEM ORSI: 30026691
57423	Boccola			Ø INTERNO = 16,5 mm Ø ESTERNO = 25 mm ALTEZZA = 55 mm	
57442	Boccola			Ø INTERNO = 16,5 mm Ø ESTERNO = 25 mm ALTEZZA = 60 mm	

GRILLI

ARTICOLO	DESCRIZIONE		MISURE LA = mm LU = mm	Ø FORO mm	FILO mm	NOTE
56351	Cavallotto Girato		LA = 48 LU = 63	11,5	Ø 11	
56322	Cavallotto		LA = 49 LU = 73	15	Ø 13	
57120	Grillo girato		LA = 48 LU = 63	12,5	Ø 11	

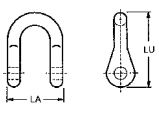
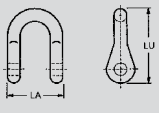
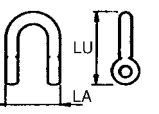
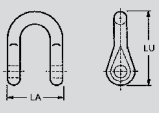
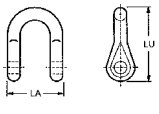
segue GRILLI

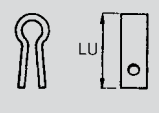
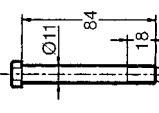
ARTICOLO	DESCRIZIONE	 MISURE LA = mm LU = mm	Ø FORO mm	FILO mm	NOTE
57121	Grillo fissaggio	 LA = 44 LU = 65	11,5	Ø 11	
56400	Grillo fissaggio	 LA = 34 LU = 64	12,5	Ø 10	
57122	Grillo fissaggio	 LA = 49 LU = 72	14,5	Ø 13	
56812	Grillo fissaggio	 LA = 49 LU = 72	16,5	Ø 13	
56347	Grillo fissaggio	 LA = 49 LU = 66	11,5	Ø 11	
57123	Grillo fissaggio	 LA = 49 LU = 70	11,5	Ø 14	
57124	Grillo fissaggio	 LA = 49 LU = 72	15,5	Ø 14	
57125	Grillo fissaggio	 LA = 42 LU = 46	9	Ø 8	
56342	Cavallotto	 LA = 48 LU = 66	12,5	Ø 11	
55830	Brida	 LA = LU = 103	14,5	35X8	
56199	Vite 7/16 x 84 5.952.24				

Zappe - Coltelli - Denti - Lame - Molle

BLADES - SPARE TINES FOR ROTARY HARROWS - CULTIVATOR SPRINGS

03

03

MAZZE PER TRINCIA

MARTEAUX DE BROEURS - STICKS SEEDS-CUTTINGS - ZWICKSTIFTESCHNEIDEMASCHINE - MAZAS DESMENZADORAS DE SEMILLA

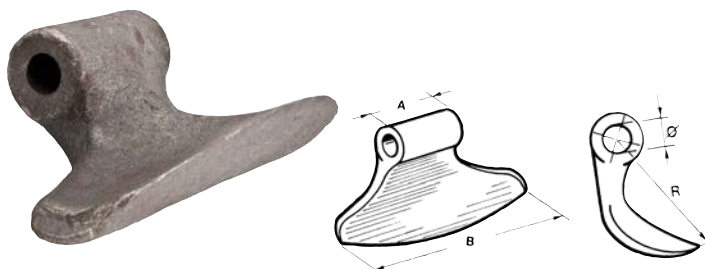

ARTICOLO	A mm	B mm	Ø FORO mm	R mm	PESO kg	APPLICAZIONI
56255	70	170	16,5	80	1,90	FISCHER - CHABAS - ROTORAM - VOTEX - HMF

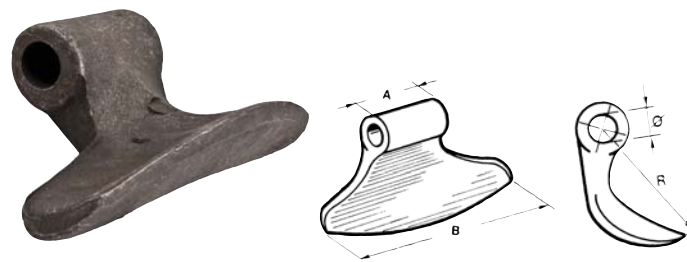

ARTICOLO	A mm	B mm	Ø FORO mm	R mm	PESO kg	APPLICAZIONI
56178	70	185	16,5	88	2,15	S.C.A.I. - CABE - AEDES - ROTORAM - AGRICOM - CHABAS - FISCHER - HMF - VOTEX
55452	70	185	20,5	88	2,15	S.C.A.I. - CABE - AEDES - AGRICOM - SEKO

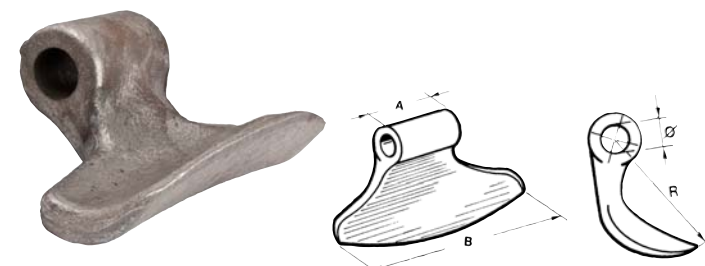

ARTICOLO	A mm	B mm	Ø FORO mm	R mm	PESO kg	APPLICAZIONI
55450	60	150	20,5	88	1,85	COSMAG - GESTIN - SAUERBURGER - RINIERI (1371661) - HUMUS - MASCHIO - SICMA - CELLI (722580) - PICURSA

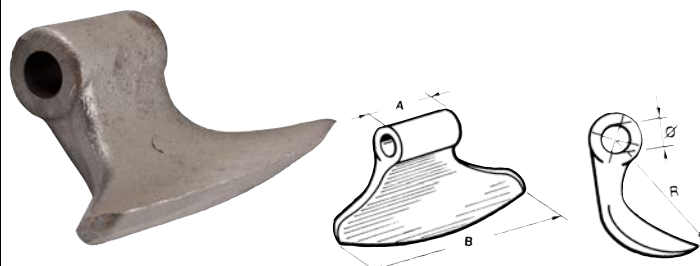

ARTICOLO	A mm	B mm	Ø FORO mm	R mm	PESO kg	APPLICAZIONI
55932	75	200	20,5	100	2,10	ROSATELLO - PERFECT (W-11624) - MEAAT

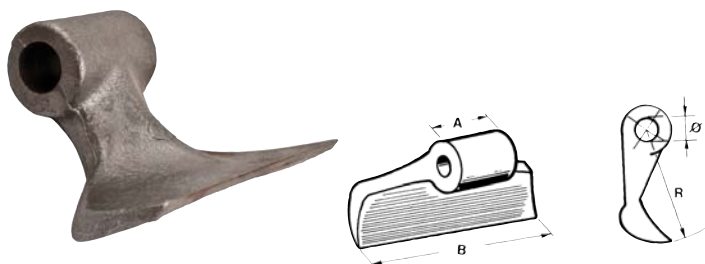

ARTICOLO	A mm	B mm	Ø FORO mm	R mm	PESO kg	APPLICAZIONI
57281	60	150	20,5	90	1,35	MASCHIO 03400410

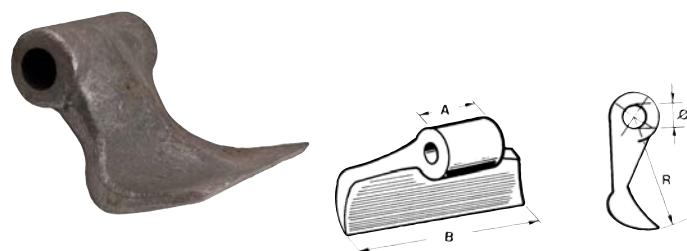

ARTICOLO	A mm	B mm	Ø FORO mm	R mm	PESO kg	APPLICAZIONI
56779	74	100	16,5	100	1,25	DRAGONE (3045/46)
56791	74	100	18,5	100	1,25	DRAGONE

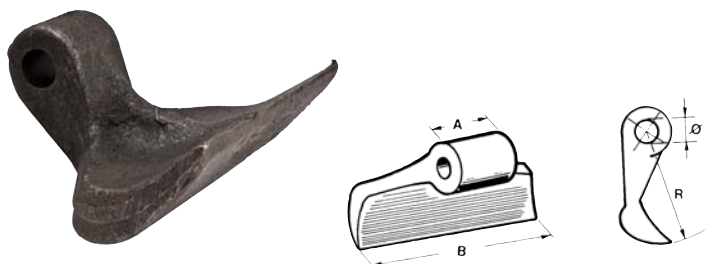

ARTICOLO	A mm	B mm	Ø FORO mm	R mm	PESO kg	APPLICAZIONI
56807	40	137	16,5	95	1,80	BERTI PESANTE - MEAAT
57134	40	137	20,5	95	1,45	FAUSTINI - UBALDI - ZAPPATOR

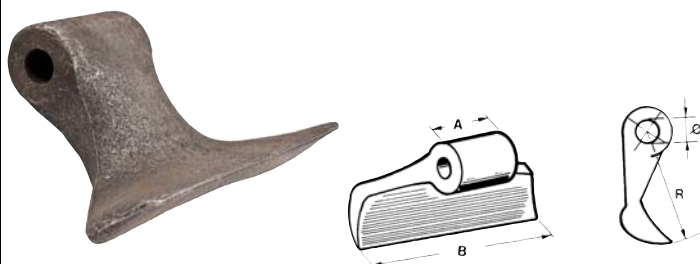

ARTICOLO	A mm	B mm	Ø FORO mm	R mm	PESO kg	APPLICAZIONI
55915	70	180	16,5	100	2,30	FERRI (09.01.016) - SICMA

segue MAZZE PER TRINCIA

MARTEAUX DE BROYEURS - STICKS SEEDS-CUTTINGS - ZWICKSTIFTESCHNEIDEMASCHINE - MAZAS DESMENZADORAS DE SEMILLA

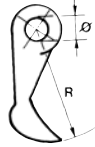
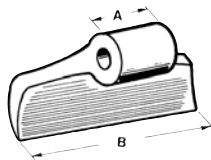

ARTICOLO	A mm	B mm	Ø FORO mm	R mm	PESO kg	APPLICAZIONI
55918	55	150	16,5	100	1,70	FALCONERO-SICMA-AGRIMASTER-MURATORI-ZAPPATOR - CEAL - SOVEMA
56182	55	150	20,5	100	1,70	FALCONERO-SICMA-MURATORI-ORSI-UBALDI-ZANON - AGRIMASTER (3001199), - AGROMECC, ZAPPATOR - AGRICOM - CALDERONI - MASCHIO - PICURSA (OEM. ORSI: 00023012 - AGRIMASTER 3000119)

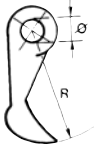
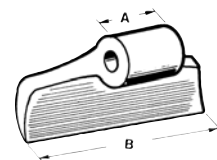

ARTICOLO	A mm	B mm	Ø FORO mm	R mm	PESO kg	APPLICAZIONI
57298	42	105	20,5	120	1,30	UBALDI

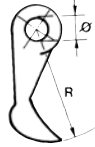
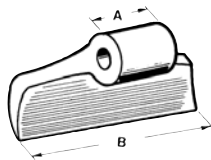

ARTICOLO	A mm	B mm	Ø FORO mm	R mm	PESO kg	APPLICAZIONI
55507	40	120	14,5	90	1,10	ZANON - ORSI
55919	40	120	16,5	90	1,10	SEPPI (119533 TYP SMW) - TORTELLA - CABE - HOWARD (2220 22001), AGRICOM, FAURI, FORIGO - BECCHIO (TM 152), MALETTI - ZANON - ZAPPATOR - MEGAMETAL
56804	40	120	19,5	90	1,10	SICMA - AGRICOM - BECCHIO
55449	40	120	20,5	90	1,10	CABE - ZAPPATOR - AGRICOM - FORIGO - SEPPI - ZANON - AGRIMASTER - MASCHIO

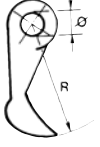
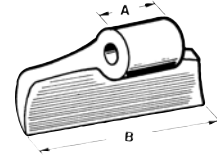

ARTICOLO	A mm	B mm	Ø FORO mm	R mm	PESO kg	APPLICAZIONI
55920	40	120	16,5	110	1,35	SEPPI - KUHN (606.170.0) - MALETTI - NOBILI - MASCHIO - AGRICOM - BECCHIO - MEAT - OMARV (CL00323) - ZAPPATOR - PERUGINI - SICMA - HOWARD - KVERNELAND - RINIERI
55448	40	120	18,5	110	1,35	OMARV - AGRAM
56805	40	120	19,5	110	1,30	SICMA - AGRICOM - BECCHIO (F141)
56801	40	120	20,5	110	1,30	ZAPPATOR - SICMA - DESVOYS - SEPPI

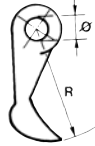
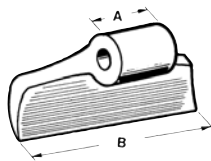

ARTICOLO	A mm	B mm	Ø FORO mm	R mm	PESO kg	APPLICAZIONI
57300	40	116	16,5	100	1,30	AGRICOM

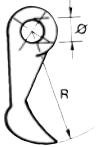
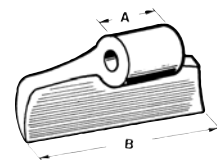

ARTICOLO	A mm	B mm	Ø FORO mm	R mm	PESO kg	APPLICAZIONI
55921	60	150	16,5	88	1,50	BERMATINGEN - HUMUS - SAUEBUGER
56794	60	150	20,5	88	1,45	BERMATINGEN - COSMAG - SICMA - MASCHIO (0300410R) - GESTIN - RINIERI

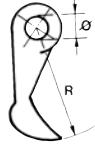
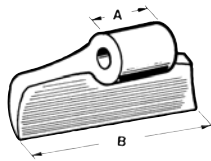

ARTICOLO	A mm	B mm	Ø FORO mm	R mm	PESO kg	APPLICAZIONI
56776	22	110	16,5	100	0,70	VIGOLO - OMARV - FERRI (09.01.134) - KUHN - PERFECT - ZILLI
55473	22	110	20,5	100	0,70	PERFECT - ZILLI
56183	22	110	25,5	100	0,70	MURATORI

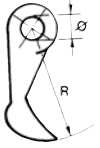
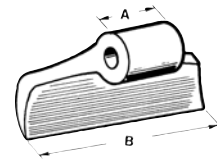

ARTICOLO	A mm	B mm	Ø FORO mm	R mm	PESO kg	APPLICAZIONI
56795	17	110	14,5	105	0,77	MURATORI (12014400) - OMARV

Zappe - Coltelli - Denti - Lame - Molle

BLADES - SPARE TINES FOR ROTARY HARROWS - CULTIVATOR SPRINGS

03

03

segue MAZZE PER TRINCIA

MARTEAUX DE BROyeurs - STICKS SEEDS-CUTTINGS - ZWICKSTIFTESCHNEIDEMASCHINE - MAZAS DESMENZADORAS DE SEMILLA

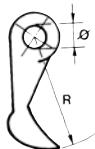
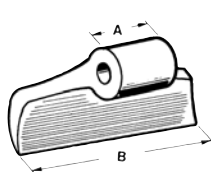

ARTICOLO	A mm	B mm	Ø FORO mm	R mm	PESO kg	APPLICAZIONI
55922	40	140	16,5	95	1,60	VIGOLO - MASCHIO - FAUSTINI - MALETTI - MEAAT - AGRICOM - AGRITEC - BERTI (MP/0008) - BREVIGLIERI (0056123) - VOGEL&NOOT (9300 00024)
55447	40	140	18,5	95	1,60	MEAAT - OMARV - VIGOLO - NIUBO

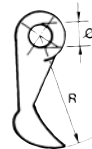
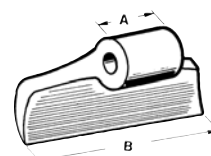

ARTICOLO	A mm	B mm	Ø FORO mm	R mm	PESO kg	APPLICAZIONI
56598	40	115	16,5	105	1,24	MASCHIO - (T21004025) - MALETTI - KUHN (606.190.0) - KVERNELAND (6303076)

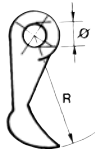
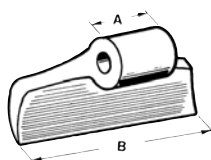

ARTICOLO	A mm	B mm	Ø FORO mm	R mm	PESO kg	APPLICAZIONI
56788	50	114	26,0	171,5	1,42	KUHN (606.169.9) - BECCHIO (CL280) - NOBILI

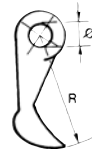
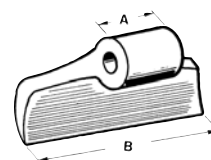

ARTICOLO	A mm	B mm	Ø FORO mm	R mm	PESO kg	APPLICAZIONI
56790	40	137	16,5	100	1,15	BERTI - MÜTHING (2405003055) - TORTELLA - FAUSTINI - BERTI (ML/007) - AGRITEC (AP-00889)

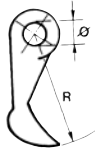
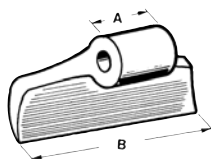

ARTICOLO	A mm	B mm	Ø FORO mm	R mm	PESO kg	APPLICAZIONI
56793	36	120	16,5	110	1,18	NOBILI - KUHN (OEM NOBILI: 1891002) (OEM KUHN: 6061700)

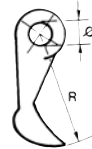
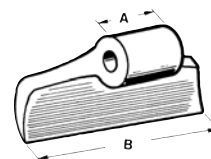

ARTICOLO	A mm	B mm	Ø FORO mm	R mm	PESO kg	APPLICAZIONI
56796	13	78	16,5	75	0,28	DRAGONE MINI

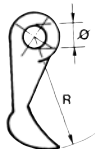
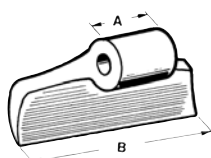

ARTICOLO	A mm	B mm	Ø FORO mm	R mm	PESO kg	APPLICAZIONI
56800	96	165	22,5	115	2,42	TORTELLA

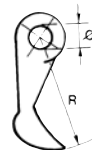
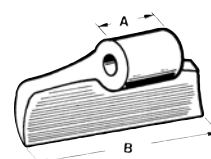

ARTICOLO	A mm	B mm	Ø FORO mm	R mm	PESO kg	APPLICAZIONI
57316	85	136	20,5	100	2,30	BERTI FORESTALE

segue MAZZE PER TRINCIA

MARTEAUX DE BROyeurs - STICKS SEEDS-CUTTINGS - ZWICKSTIFTESCHNEIDEMASCHINE - MAZAS DESMENZADORAS DE SEMILLA

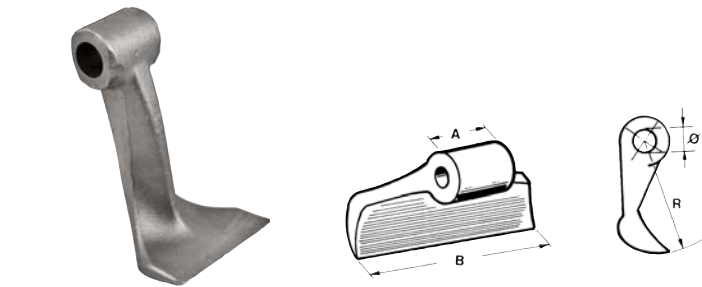

ARTICOLO	A mm	B mm	Ø FORO mm	R mm	PESO kg	APPLICAZIONI
57314	56	105	26	164	1,65	VIGOLO

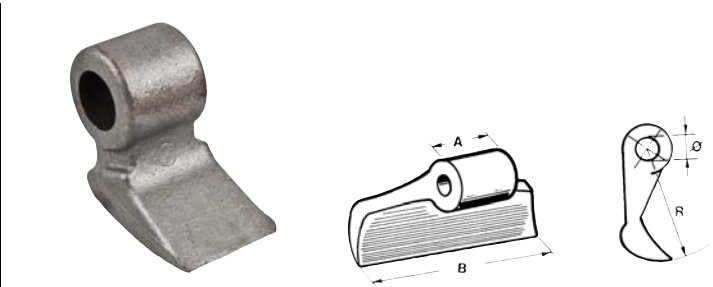

ARTICOLO	A mm	B mm	Ø FORO mm	R mm	PESO kg	APPLICAZIONI
57313	60	70	36	110	2,40	SEPPI - FAE - BERTI - GANDINI - CARAVAGGI - PICURSA

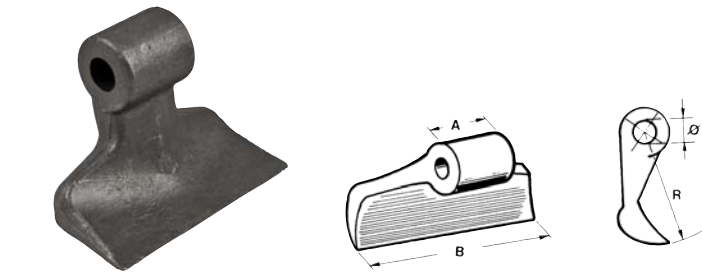

ARTICOLO	A mm	B mm	Ø FORO mm	R mm	PESO kg	APPLICAZIONI
57315	51	136	19,5	95	-	BERTI (TFB/Y200)

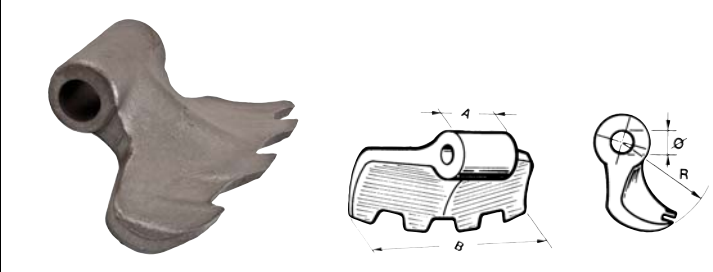

ARTICOLO	A mm	B mm	Ø FORO mm	R mm	PESO kg	APPLICAZIONI
55451	70	165	16,5	88	1,50	FISCHER - VOTEX - CHABAS - ROTORAM - HMF - PALLADINO - FREI - PEGORARO
56164	70	165	20,5	88	1,50	FISCHER

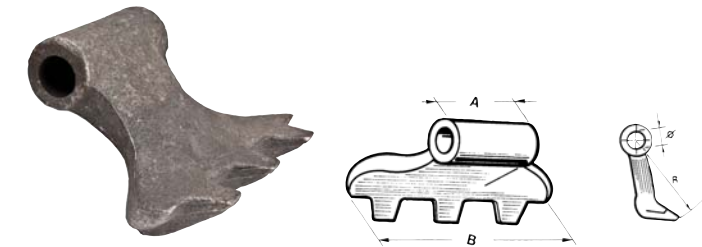

ARTICOLO	A mm	B mm	Ø FORO mm	R mm	PESO kg	APPLICAZIONI
55855	90	160	20,5	110	2,18	WILLIBALD - NOBILI - LIPA - PALLADINO - KUHN (606.000.7)

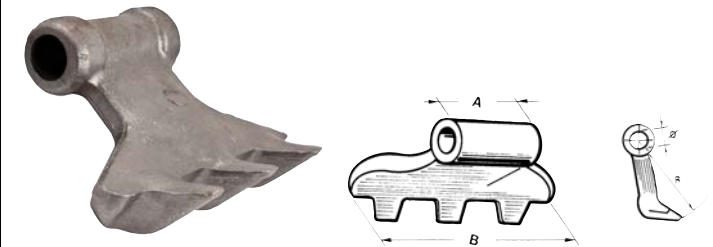

ARTICOLO	A mm	B mm	Ø FORO mm	R mm	PESO kg	APPLICAZIONI
56799	98	166	22,5	116	2,07	TORTELLA

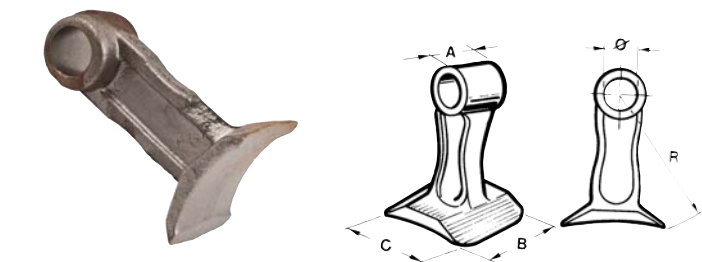

ARTICOLO	A mm	B mm	C mm	Ø FORO mm	R mm	PESO kg	APPLICAZIONI
55935	42	65	80	25,5	115	1,20	FERRI

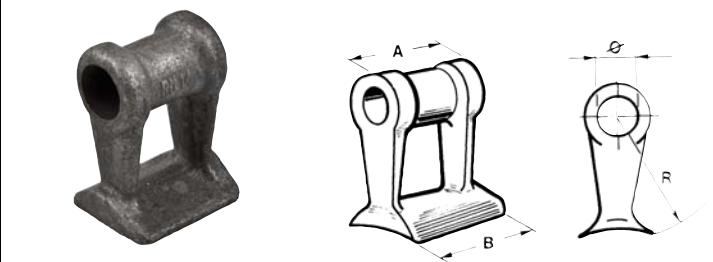

ARTICOLO	A mm	B mm	Ø FORO mm	R mm	PESO kg	APPLICAZIONI
55923	58	65	25,5	70	0,50	ROUSSEAU (5.254.06/5.524.45) - NICOLAS - NOREMAT - MULAG (TM 60-07-0223) - SMA (100 1471)

Zappe - Coltelli - Denti - Lame - Molle

BLADES - SPARE TINES FOR ROTARY HARROWS - CULTIVATOR SPRINGS

03

03

segue MAZZE PER TRINCIA

MARTEAUX DE BROYEURS - STICKS SEEDS-CUTTINGS - ZWICKSTIFTESCHNEIDEMASCHINE - MAZAS DESMENZADORAS DE SEMILLA

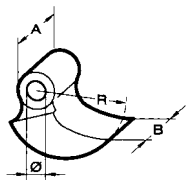

ARTICOLO	A mm	B mm	Ø FORO mm	R mm	PESO kg	APPLICAZIONI
56194	60	70	30,5	80	1,50	SEPPI - FAE - BERTI - ORSI - AGRIMASTER - PICURSA

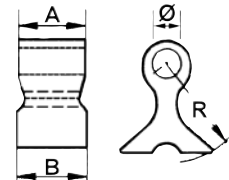

ARTICOLO	A mm	B mm	Ø FORO mm	R mm	PESO kg	APPLICAZIONI
56808	60	70	31	78	1,53	SEPPI
57591	80	70	31	85	1,90	BERTI Forestale

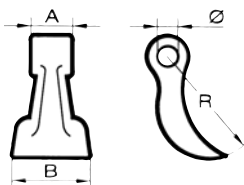

ARTICOLO	A mm	B mm	Ø FORO mm	R mm	PESO kg	APPLICAZIONI
56189	40	85	14,5	95	0,70	AGRIMASTER (71009) - AGROMECC (300.10.95) - ORSI - SICMA - ZANON - DEL MORINO
56190	40	85	16,5	95	0,70	AGRIMASTER - MASCHIO 07400950R - UBALDI - ACMA - AGRICOM - ORTOLAN - PICURSA
57617	40	85	20,5	95	0,70	AGRIMASTER (3009799)

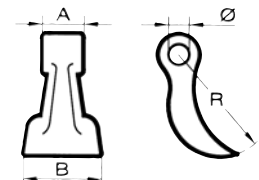

ARTICOLO	A mm	B mm	Ø FORO mm	R mm	PESO kg	APPLICAZIONI
57461	39	100	14,5	103	0,70	AGRIMASTER
57462	39	100	16,5	103	0,70	
56599	39	100	20,5	103	0,70	

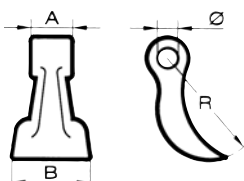

ARTICOLO	A mm	B mm	Ø FORO mm	R mm	PESO kg	APPLICAZIONI
56600	30	120	25,5	120	0,88	AGRIMASTER

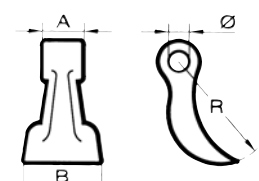

ARTICOLO	A mm	B mm	Ø FORO mm	R mm	PESO kg	APPLICAZIONI
56601	70	160	20,5	160	2,25	FACMA - AGRICOM
56117	70	160	22,5	160	2,25	FACMA

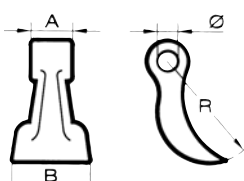

ARTICOLO	A mm	B mm	Ø FORO mm	R mm	PESO kg	APPLICAZIONI
57466	40	95	12,5	95	0,62	SICMA - FERRI (OEM FERRI: 0901194) - AGRICOM - PERUZZO
56802	40	95	16,5	95	0,62	

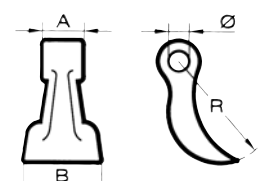

ARTICOLO	A mm	B mm	Ø FORO mm	R mm	PESO kg	APPLICAZIONI
56803	10	85	14,5	100	0,38	MURATORI: OEM 12019400

segue MAZZE PER TRINCIA

MARTEAUX DE BROYEURS - STICKS SEEDS-CUTTINGS - ZWICKSTIFTESCHNEIDEMASCHINE - MAZAS DESMENZADORAS DE SEMILLA

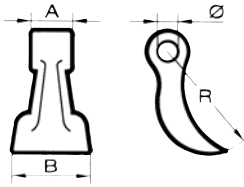

ARTICOLO	A mm	B mm	Ø FORO mm	R mm	PESO kg	APPLICAZIONI
56806	22	75	16,5	92	0,67	HMF - VIGOLO

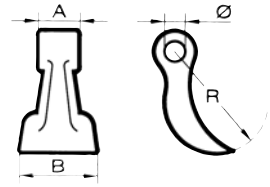

ARTICOLO	A mm	B mm	Ø FORO mm	R mm	PESO kg	APPLICAZIONI
57318	42	80	13	80	0,42	GEO

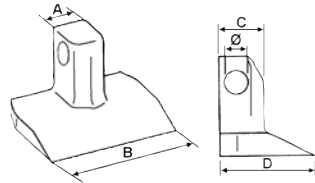

ARTICOLO	A mm	B mm	C mm	D mm	Ø FORO mm	R mm	PESO kg	APPLICAZIONI
56789	30	105	36,5	75	16,5	-	1,25	MERITANO

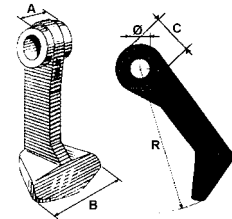

ARTICOLO	A mm	B mm	C mm	Ø FORO mm	R mm	PESO kg	APPLICAZIONI
56792	51	88	60	26,0	180	2,17	NOBILI

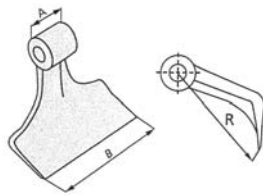

ARTICOLO	A mm	B mm	Ø FORO mm	R mm	PESO kg	APPLICAZIONI
57317	40	130	16,5	110	1,05	MASCHIO Mod.: BC, BE, BL, VITA, BELLA, BRAVA, TRITONE OEM: 24004025

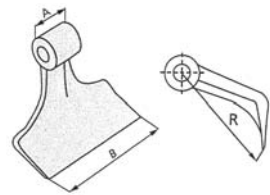

ARTICOLO	A mm	B mm	Ø FORO mm	R mm	PESO kg	APPLICAZIONI
57384	10	62	14,5	62	0,21	CALDERONI - ORSI - TORTELLA - UBALDI - FERRI - SICMA (5715103)

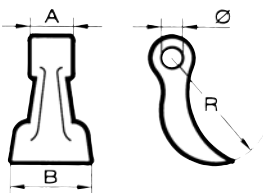

ARTICOLO	A mm	B mm	Ø FORO mm	R mm	PESO kg	APPLICAZIONI
57443	44	60	25,5	70	0,75	AGRIMASTER OEM: 3008045

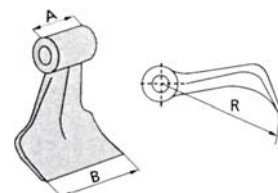

ARTICOLO	A mm	B mm	Ø FORO mm	R mm	PESO kg	APPLICAZIONI
57459	47	85	14,5	97	0,65	AGRIMASTER

Zappe - Coltelli - Denti - Lame - Molle

BLADES - SPARE TINES FOR ROTARY HARROWS - CULTIVATOR SPRINGS

03

03

segue MAZZE PER TRINCIA

MARTEAUX DE BROyeurs - STICKS SEEDS-CUTTINGS - ZWICKSTIFTESCHNEIDEMASCHINE - MAZAS DESMUNUZADORAS DE SEMILLA

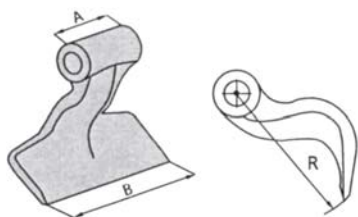

ARTICOLO	A mm	B mm	Ø FORO mm	R mm	PESO kg	APPLICAZIONI
57460	73	165	18,5	114	1,75	FACMA

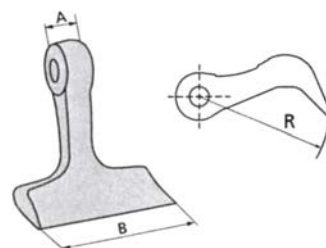

ARTICOLO	A mm	B mm	Ø FORO mm	R mm	PESO kg	APPLICAZIONI
57463	24	100	16,5	110	0,95	FERRI OEM: 0901134

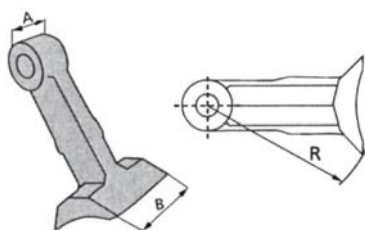

ARTICOLO	A mm	B mm	Ø FORO mm	R mm	PESO kg	APPLICAZIONI
57464	24	64	16,5	113	0,75	FERRI OEM: 0901147

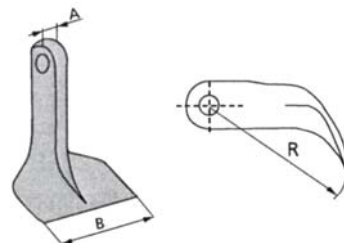

ARTICOLO	A mm	B mm	Ø FORO mm	R mm	PESO kg	APPLICAZIONI
57465	10	65	12,5	87	0,20	PERUZZO

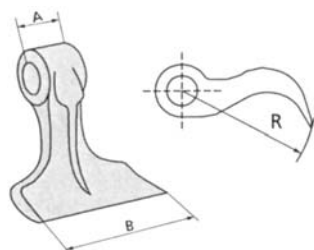

ARTICOLO	A mm	B mm	Ø FORO mm	R mm	PESO kg	APPLICAZIONI
57467	32	95	22,5	100	0,70	NOBILI

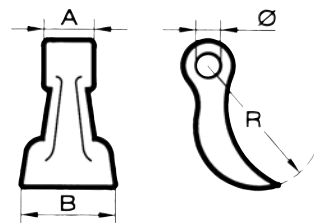

ARTICOLO	A mm	B mm	Ø FORO mm	R mm	PESO kg	APPLICAZIONI
57468	45	125	25,5	177	1,55	MASCHIO OEM:T30004025

new

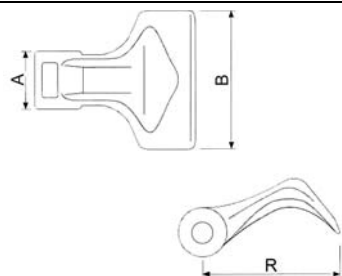

ARTICOLO	A mm	B mm	Ø FORO mm	R mm	PESO kg	APPLICAZIONI
57608	40	95	16,5	95	0,78	SICMA

new

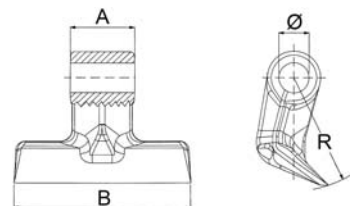

ARTICOLO	A mm	B mm	Ø FORO mm	R mm	PESO kg	APPLICAZIONI
57630	54	148	25,5	96	2,04	FALC

segue MAZZE PER TRINCIA

MARTEAUX DE BROYEURS - STICKS SEEDS-CUTTINGS - ZWICKSTIFTESCHNEIDEMASCHINE - MAZAS DESMENZADORAS DE SEMILLA

new

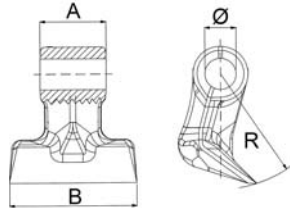

ARTICOLO	A mm	B mm	Ø FORO mm	R mm	PESO kg	APPLICAZIONI
57631	54	105	25,5	95	1,6	FALC

new

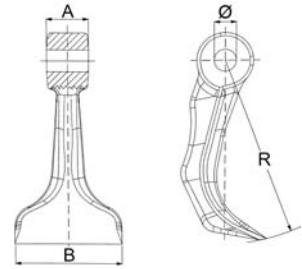

ARTICOLO	A mm	B mm	Ø FORO mm	R mm	PESO kg	APPLICAZIONI
57632	40	100	20,5	171	1,95	BERTI tipo lungo

new

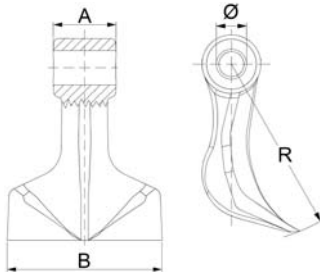

ARTICOLO	A mm	B mm	Ø FORO mm	R mm	PESO kg	APPLICAZIONI
57693			16,5			FERRI
57694	42	105	20,5	120	1,4	FERRI
57695			25,5			FEEMAC

new

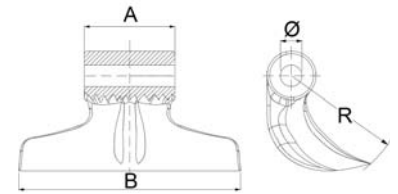

ARTICOLO	A mm	B mm	Ø FORO mm	R mm	PESO kg	APPLICAZIONI
57676	70	170	16,5	90	2,1	KUHN DX
57677			20,5			HMF

new

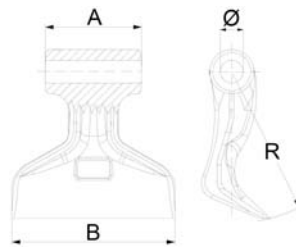

ARTICOLO	A mm	B mm	Ø FORO mm	R mm	PESO kg	APPLICAZIONI
57696	70	118	16,5	110	1,47	FERRI (OEM: 0901196)

new

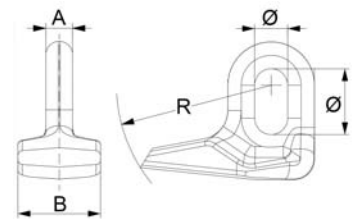

ARTICOLO	A mm	B mm	Ø ASOLA mm	R mm	PESO kg	APPLICAZIONI
57697	13	40	16X32	75	0,41	BOMFORD-BRUNI

new

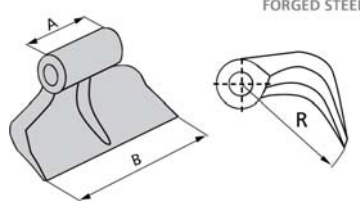

FORGED STEEL

ARTICOLO	A mm	B mm	Ø FORO mm	R mm	PESO kg	APPLICAZIONI
57715	81	171	20,5	95	2,70	FERNANDEZ

new

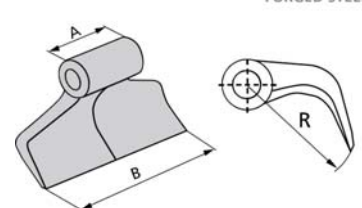

FORGED STEEL

ARTICOLO	A mm	B mm	Ø FORO mm	R mm	PESO kg	APPLICAZIONI
57713	80	190	18,5	95	2,0	NIUBO
57714	80	190	23	95	2,0	NIUBO

Zappe - Coltelli - Denti - Lame - Molle

BLADES - SPARE TINES FOR ROTARY HARROWS - CULTIVATOR SPRINGS

03

03

segue MAZZE PER TRINCIA

MARTEAUX DE BROyeurs - STICKS SEEDS-CUTTINGS - ZWICKSTIFTESCHNEIDEMASCHINE - MAZAS DESMENZADORAS DE SEMILLA

new

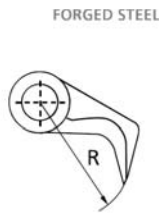
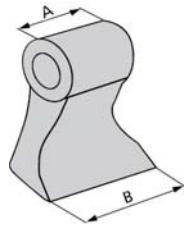

FORGED STEEL

ARTICOLO	A mm	B mm	Ø FORO mm	R mm	PESO kg	APPLICAZIONI
57708	81	125	35	109	2,70	SERRAT

new

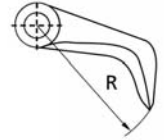
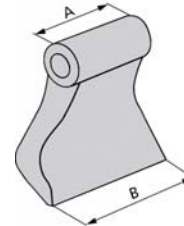

FORGED STEEL

ARTICOLO	A mm	B mm	Ø FORO mm	R mm	PESO kg	APPLICAZIONI
57709	82	123	20,5	105	2,00	SERRAT

new

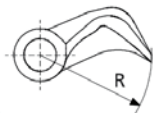
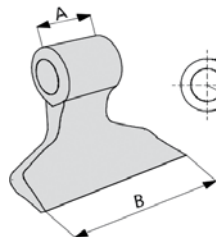

FORGED STEEL

ARTICOLO	A mm	B mm	Ø FORO mm	R mm	PESO kg	APPLICAZIONI
57710	60	151	28,5	98	1,90	TMC CANCELA

new

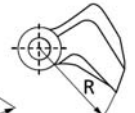
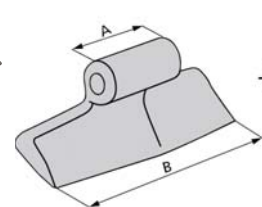

FORGED STEEL

ARTICOLO	A mm	B mm	Ø FORO mm	R mm	PESO kg	APPLICAZIONI
57711	87	224	20,5	78	2,70	TMC CANCELA

new

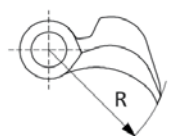
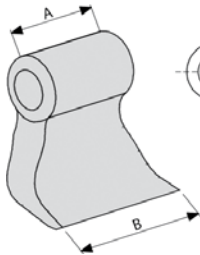

FORGED STEEL

ARTICOLO	A mm	B mm	Ø FORO mm	R mm	PESO kg	APPLICAZIONI
57712	80	110	28,5	98	2,27	TMC CANCELA

BULLONI PER MAZZE TRINCIARAMI CLASSE 10.9

Boulons pour massue coupe-branches en 10.9
Bolts for shredder branch-rams in 10.9
Bolzen für Hammer des Zweigschneiders in 10.9
Pernos por martillos trincharamas en 10.9

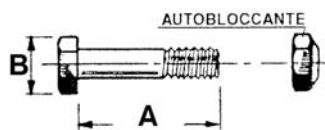

ARTICOLO	MISURA	A mm	B mm	APPLICAZIONE
▶ 56592	M12x1,75	55	19	BRUNI 1° tipo
57622	M12x1,75	60	19	-
56593	M12x1,75	65	19	BRUNI 2° tipo
56594	M12x1,75	90	19	FERRI
▶ 57623	M12x1,75	100	19	-
56199	7/16" (11,1)	84	16	ROUSSEAU-SMA-FERRI-MALETTI
▶ 56595	7/16" (11,1)	62	16	ZAPPATOR-ROUSSEAU-SMA-FERRI
57625	7/16" (11,1)	95	16	-
57319	M14x2	60	22	-
▶ 57624	M14x2	90	22	-
56602	M16x1,5	90	24	-
56564	M16x1,5	100	24	-
56603	M16x1,5	130	24	-
57223	M18x1,5	100	27	-
57444	M18x1,5	120	27	per mazza 57315
57224	M20x1,5	100	30	-
▶ 57627	M20x1,5	110	30	-
57628	M20x1,5	120	30	-
57225	M20x1,5	130	30	-
▶ 57629	M20x1,5	140	30	-
56596	M16x2	60	24	ORSI
56597	M16x2	75	24	FERRI
57388	M16x2	90	27	-
57389	M16x2	100	27	-
▶ 57626	M16x2	130	27	-

BULLONI CON VITE A TESTA QUADRA PER TRINCIA -BERTI-

Boulons pour massue coupe-branches en 10.9
Bolts for shredder branch-rams in 10.9
Bolzen für Hammer des Zweigschneiders in 10.9
Pernos por martillos trincharamas en 10.9

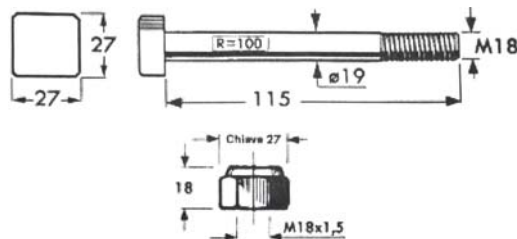

ARTICOLO	DESCRIZIONE	APPLICAZIONI	OEM
57705	Vite a testa quadrata 27x27 - Ø19x115 - M18	BERTI Serie A, Y	VTQ27M18/3921 100.100.001
57706	Dado M18x1,5 per 57705	BERTI Serie A, Y	DE18AL6SPFZAB 101.500.007

SUPPORTO PER MAZZE PER TRINCIA

SUPPORTS POUR MARTEAUX DE BROyeurs - SUPPORTS FOR STICK SEEDS-CUTTINGS -
LAGER FÜR ZWICKSTIFTE-SCHNEIDEMASCHINE - SOPORTES PARA MAZZAS DESMENEZADORAS DE SEMILLA

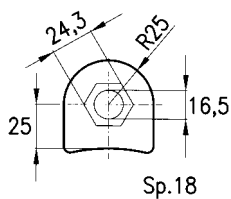

ARTICOLO
56494

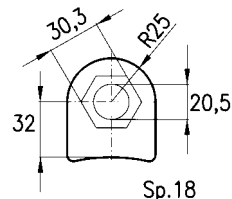

ARTICOLO
56495

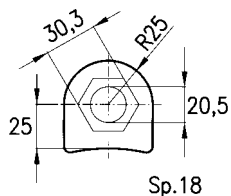

ARTICOLO
56496

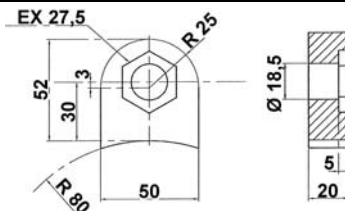

ARTICOLO
57456

Zappe - Coltelli - Denti - Lame - Molle

BLADES - SPARE TINES FOR ROTARY HARROWS - CULTIVATOR SPRINGS

03

COLTELLI PER SCAVAFOSSI

COUTEAUX POUR FOSSEUSES - TRENCHER BLADES - MESSER FÜR GRABENBAGGER - CUCHILAS PARA ABREZANJAS

ARTICOLO	DESCRIZIONE	DISEGNO	MISURE mm	FORI Ø mm	INTERASSE mm	PIATTO mm	PESO g	OEM
56883	Piastrina DMR 25 - 25S - 35 - 35S		L = 95 H =	10,5	30	50x10	330	-
56884	Piastrina DMR 45 - 55 - 65 - 75 - 90 - 95		L = 120 H =	12,5	50	60x12	600	-
56885	Angolare int. 3 fori S/25A - 25S - 35 - 35S - sx		L = 185 H = 60	12,5	50	90x8	850	-
56886 57137	Angolare est. 2 fori S/25B - 25S - 35 - 35S - dx S/25C - sx		L = 210 H = 60	12,5	50	90x8	1030	-
56887	Angolare int. 3 fori S/45A - sx		L = 225 H = 60	14,5	65	90x8	1000	-
56888 57138	Angolare est. 3 fori S/45B - dx S/45C - sx		L = 320 H = 65	14,5	60	100x8	1650	-
56889	Angolare int. 3 fori S/65A - sx		L = 245 H = 65	14,5	65	100x8	1380	-
56890 57139	Angolare est. 3 fori S/65B - dx S/65C - sx		L = 340 H = 65	14,5	60	100x8	1800	-
56891	Coltello lat. DMR 25/45 - 55		L = 205 H =	12,5	60	80x7	760	-
57284 57303	Drenag - dx Drenag - sx		A = 255 B = 65	14,5	50-56	70x10	1500	-
57285	Coltello disco		A = 235 B = 30	12,5	50	90x8	1260	-
57286	Angolare Destro		A = 173 B = 60 C = 55	12,5	50	90x8	920	-
57287	Angolare Sinistro		A = 173 B = 60 C = 55	12,5	50	90x8	920	-
57288 57301	Dente piegato Destro Dente piegato Sinistro		A = 112 B = 50	10,5	30	60x10	260	-
57289 57302	Unghietta Destra Unghietta Sinistra		A = 122 B = 50	12,5	50	70x12	360	-

segue **COLTELLI PER SCAVAFOSSI**



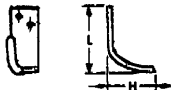

COUTEAUX POUR FOSSEUSES - TRENCH BLADES - MESSER FÜR GRABENBAGGER - CUCHILAS PARA ABREZANJAS

ARTICOLO	DESCRIZIONE	DISEGNO	MISURE mm	FORI Ø mm	INTERASSE mm	PIATTO mm	PESO g	OEM
----------	-------------	---------	--------------	-----------------	-----------------	--------------	-----------	-----

FISSORE CARITÀ

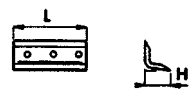
56901	Scavafossi		L = 180 H = 105	16,5	60	100x10	-	-
--------------	------------	-----------------------------------------------------------------------------------	--------------------	------	----	--------	---	---

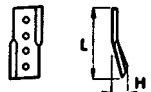
MALETTI

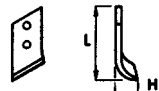
56892	Angolare 6 fori AFR/2-AFR/4R		L = 265 H = 67	14,5	75	100x10	1900	-
56893	Angolare 6 fori AFR/0S-AFR/0S-3C		L = 265 H = 67	14,5	88	100x10	1900	-
56894	Laterale 4 fori AFR/0-AFR/1C AFR/0S-AFR/0S-3C		L = 230 H = 35	14,5	60	60x10	860	-
56895	Laterale 4 fori AFR/2-AFR/4R		L = 238 H = 42	14,5	50	70x10	1100	-
56896			L = 90 H = 38	12,5	27	40x10	260	-
56897			L = 94 H = 38	12,5	27	40x10	260	-
56898	Zappina AFR/0-AFR/1C AFR/0S-AFR/0S-3C AFR/2R		L = 100 H = 38	12,5	27	40x10	260	-
56899			L = 102 H = 38	12,5	27	40x10	260	-
56900			L = 108 H = 38	12,5	27	40x10	265	-

Zappe - Coltelli - Denti - Lame - Molle

BLADES - SPARE TINES FOR ROTARY HARROWS - CULTIVATOR SPRINGS

03

03

DENTI PER ERPICE ROTANTE

DENTS POUR HERSE ROTATIVE - TINES FOR ROTARY HARROWS - ZINKE FÜR EGGEN - DIENTES PARA GRADA RODANTE

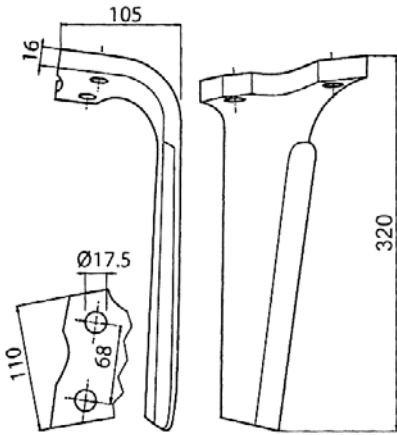

Il disegno rappresenta il particolare Dx

ARTICOLO	DESCRIZIONE	OEM
55947	Destro	52539400
55948	Sinistro	52539500
MARCA	AGROMECC	

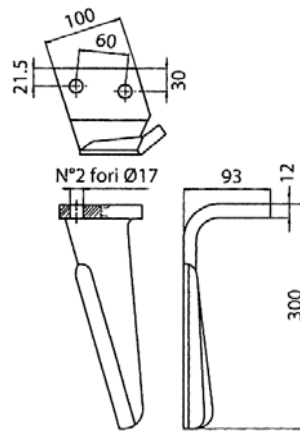

Il disegno rappresenta il particolare Sx

ARTICOLO	DESCRIZIONE	OEM
57177	DF NUOVO MOD. - Destro	
57178	DF NUOVO MOD. - Sinistro	
MARCA	ALPEGO (OEM 1270/DX+1271/SX)	

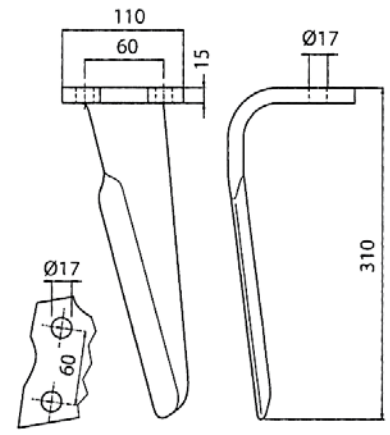

Il disegno rappresenta il particolare Sx

ARTICOLO	DESCRIZIONE	OEM
57179	DH 03000 PESANTE - Destro	
57180	DH 03001 PESANTE - Sinistro	
MARCA	ALPEGO	

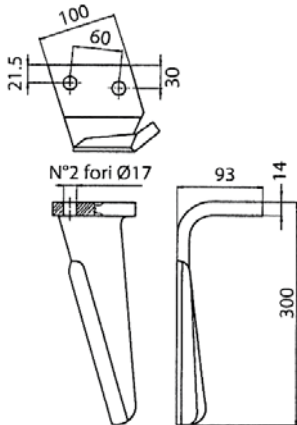

Il disegno rappresenta il particolare Sx

ARTICOLO	DESCRIZIONE	OEM
57181	DG 06700 - Destro	
57182	DG 06701 - Sinistro	
MARCA	ALPEGO	

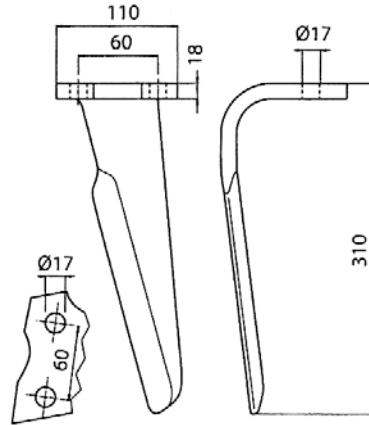

Il disegno rappresenta il particolare Sx

ARTICOLO	DESCRIZIONE	OEM
57183	RH 07400 - Destro	
57184	RH 07401 - Sinistro	
MARCA	ALPEGO	

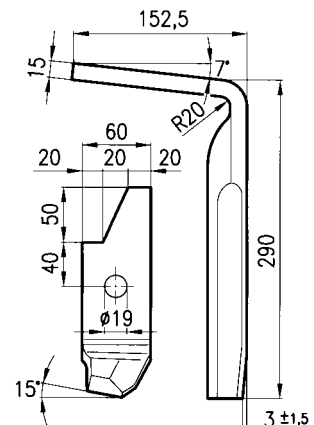

ARTICOLO	DESCRIZIONE	OEM
56503	Destro - 950788	
56504	Sinistro - 950789	
MARCA	AMAZONE	

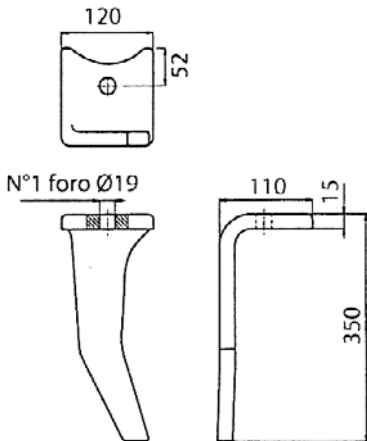

Il disegno rappresenta il particolare Dx

ARTICOLO	DESCRIZIONE	OEM
56501	CULTIMIX - Destro - 6574300	
56502	CULTIMIX - Sinistro - 6575300	
MARCA	AMAZONE	

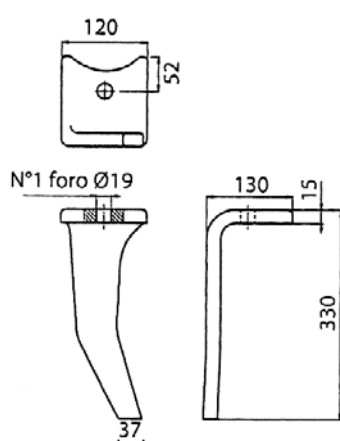

Il disegno rappresenta il particolare Dx

ARTICOLO	DESCRIZIONE	OEM
56505	CULTIMIX LARGO - Dx - 967495	
56506	CULTIMIX LARGO - Sx - 967496	
MARCA	AMAZONE	

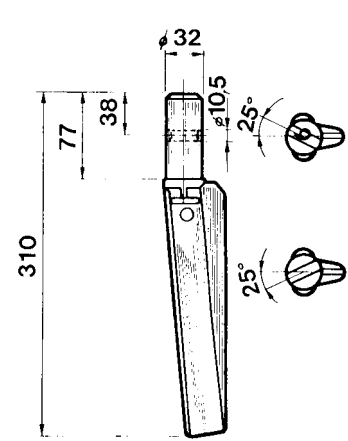

ARTICOLO	DESCRIZIONE	OEM
55017	TB333 - Gambo Ø 32 Destro	
55713	TB333 - Gambo Ø 32 Sinistro	
MARCA	BREVIGLIERI	

segue DENTI PER ERPICE ROTANTE

DENTS POUR HERSE ROTATIVE - TINES FOR ROTARY HARROWS - ZINKE FÜR EGGEN - DIENTES PARA GRADA RODANTE

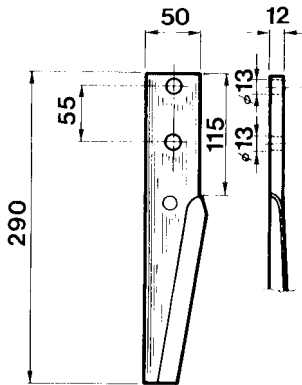

ARTICOLO	DESCRIZIONE
55014	TB250 - Destro piatto 50x12
55929	TB250 - Sinistro piatto 50x12
MARCA	BREVIGLIERI

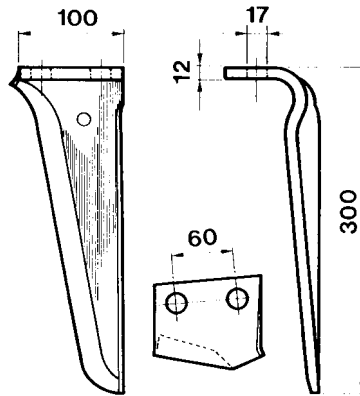

Il disegno rappresenta il particolare Sx

ARTICOLO	DESCRIZIONE
55976	T51 - Piatto 100x12 - Destro
56171	T51 - Piatto 100x12 - Sinistro
MARCA	BREVIGLIERI, ALPEGO, FERABOLI, MASCHIO (OEM 36100210+36100211), PEGORARO, SOVERNA, VIGOLO

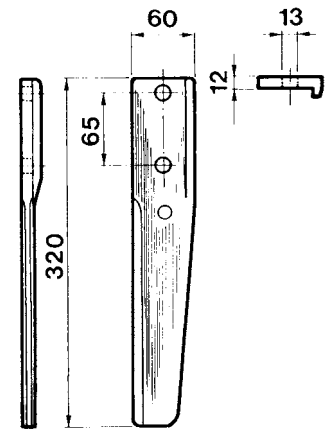

ARTICOLO	DESCRIZIONE
55936	TB422 - Destro
55937	TB422 - Sinistro
MARCA	BREVIGLIERI

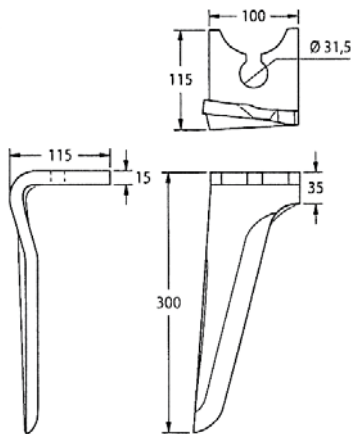

Il disegno rappresenta il particolare Dx

ARTICOLO	DESCRIZIONE
57185	COLTELLO SUPERFAST - Destro
57186	COLTELLO SUPERFAST - Sinistro
MARCA	BREVIGLIERI

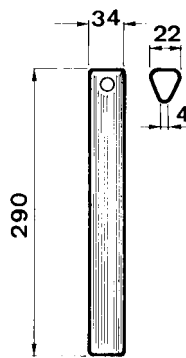

ARTICOLO	DESCRIZIONE
55019	Profilo triangolare
MARCA	CARRARO-AGRITALIA

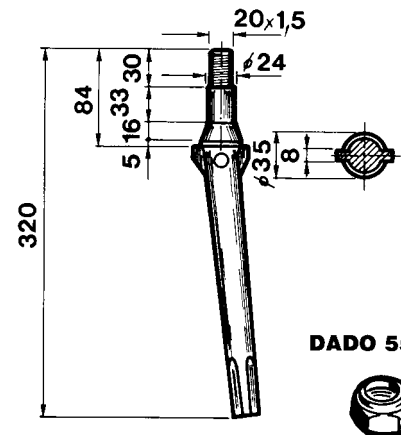

DADO 55706

ARTICOLO	DESCRIZIONE
55022	Conico
MARCA	CELLI

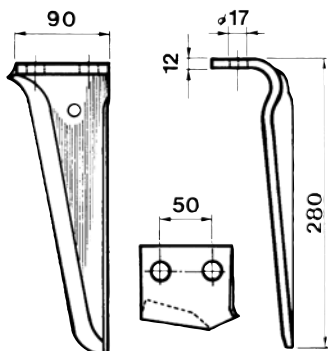

Il disegno rappresenta il particolare Sx

ARTICOLO	DESCRIZIONE
55084	Diamante Dx - Piatto 90x12
55085	Diamante Sx - Piatto 90x12
MARCA	CELLI

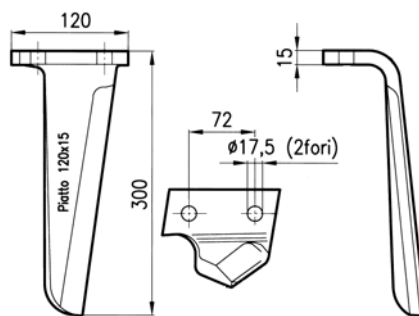

Il disegno rappresenta il particolare Dx

ARTICOLO	DESCRIZIONE
56507	Destro - Piatto 120x15
56508	Sinistro - Piatto 120x15
MARCA	CELLI (622.603/DX+622.604/SX)

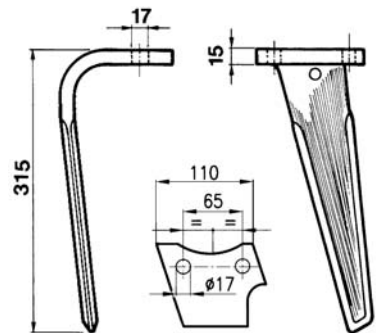

Il disegno rappresenta il particolare Dx

ARTICOLO	DESCRIZIONE
55105	Destro - R8404.50.01
55106	Sinistro - R8404.50.02
MARCA	EMY-ELENFER

Zappe - Coltelli - Denti - Lame - Molle

BLADES - SPARE TINES FOR ROTARY HARROWS - CULTIVATOR SPRINGS

03

03

segue DENTI PER ERPICE ROTANTE

DENTS POUR HERSE ROTATIVE - TINES FOR ROTARY HARROWS - ZINKE FÜR EGGEN - DIENTES PARA GRADA RODANTE

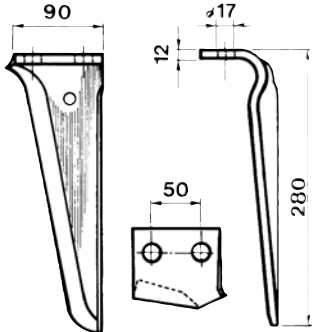

Il disegno rappresenta il particolare Sx

ARTICOLO	DESCRIZIONE
55084	Destro - Piatto 90x12
55085	Sinistro - Piatto 90x12
MARCA	FALC, FORIGO, MASCHIO (27100209+27100210), MALETTI, MORENI, PEGORARO, SICMA, VIGOLO

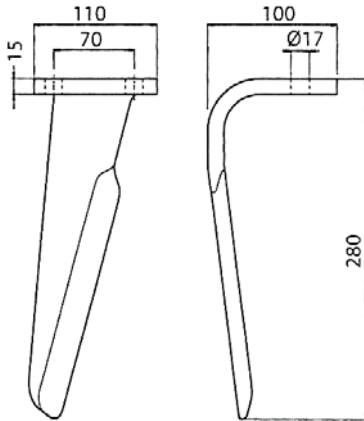

Il disegno rappresenta il particolare Dx

ARTICOLO	DESCRIZIONE
57189	BIG - Destro
57190	BIG - Sinistro
MARCA	FALC (543028+543029)

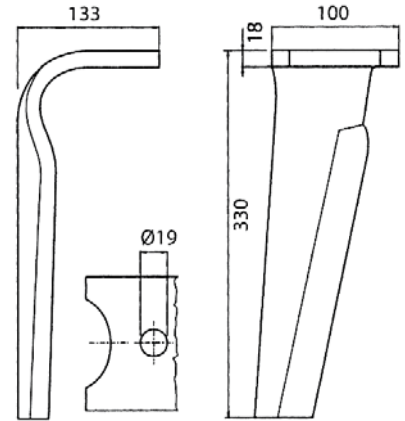

Il disegno rappresenta il particolare Dx

ARTICOLO	DESCRIZIONE
57191	MAGNUM DENTE ATT. RAP. Destro
57192	MAGNUM DENTE ATT. RAP. Sinistro
MARCA	FALC (540129+540130)

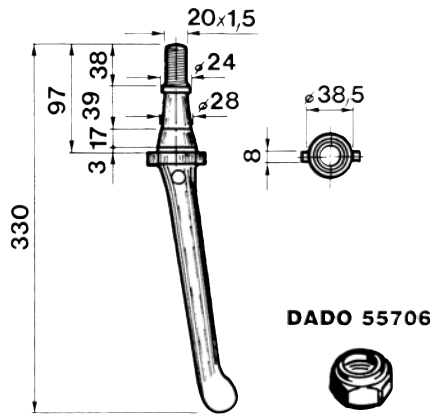

ARTICOLO	DESCRIZIONE
55074	Conico con punta a goccia
MARCA	FERABOLI (OEM LELY:1.1699.0315.0-1.1699.0106.0)

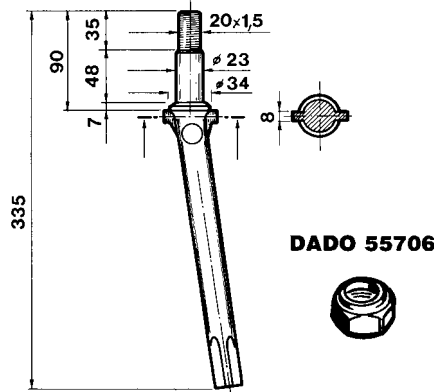

ARTICOLO	DESCRIZIONE
55079	Cilindrico - 1ª Serie
MARCA	FERABOLI

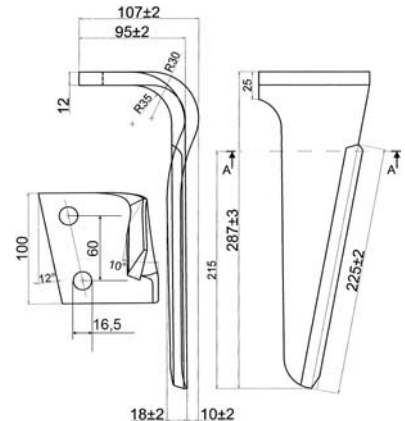

Il disegno rappresenta il particolare Dx

ARTICOLO	DESCRIZIONE	OEM
57469	2N dente Destro	7U0031
57470	2N dente Sinistro	7U0032
MARCA	FERABOLI (100x12)	

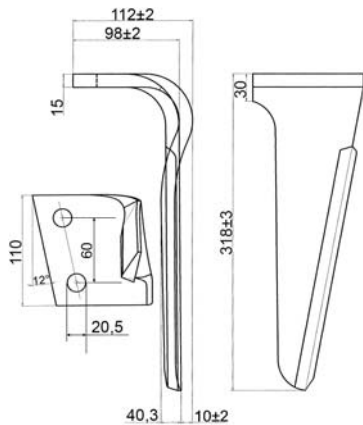

Il disegno rappresenta il particolare Dx

ARTICOLO	DESCRIZIONE	OEM
57489	TOP dente Destro	7U00033
57490	TOP dente Sinistro	7U00034
MARCA	FERABOLI (110x15)	

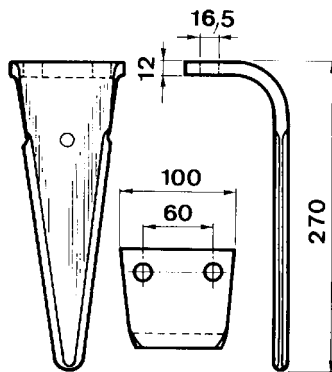

ARTICOLO	DESCRIZIONE
55942	Modello FN
MARCA	FERABOLI

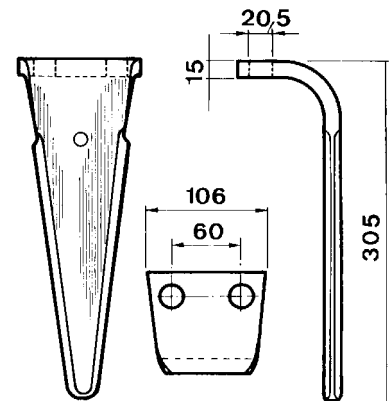

ARTICOLO	DESCRIZIONE
55943	Modello FS
MARCA	FERABOLI

segue DENTI PER ERPICE ROTANTE

DENTS POUR HERSE ROTATIVE - TINES FOR ROTARY HARROWS - ZINKE FÜR EGGEN - DIENTES PARA GRADA RODANTE

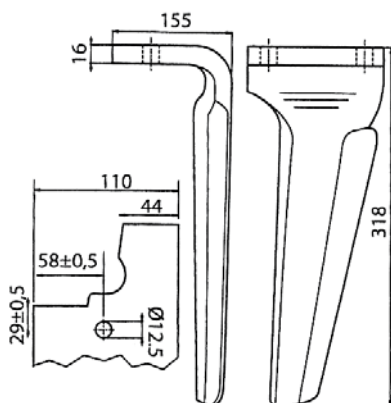

Il disegno rappresenta il particolare Dx

ARTICOLO	DESCRIZIONE
57193	ATTACCO RAPIDO - Dx - 7U000390
57194	ATTACCO RAPIDO - Sx - 7U000400
MARCA	FERABOLI

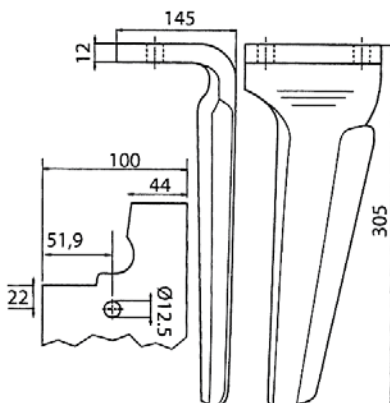

Il disegno rappresenta il particolare Dx

ARTICOLO	DESCRIZIONE
57195	ATT. RAP. LEGG. - Dx - 7U000370
57196	ATT. RAP. LEGG. - Sx - 7U000380
MARCA	FERABOLI

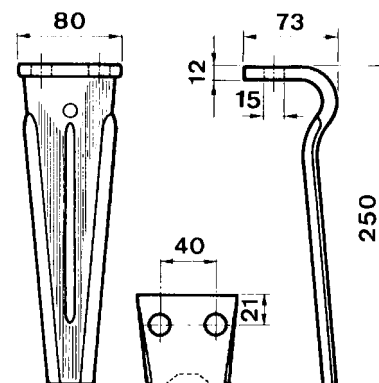

ARTICOLO	DESCRIZIONE
55508	Tipo leggero
MARCA	FORIGO

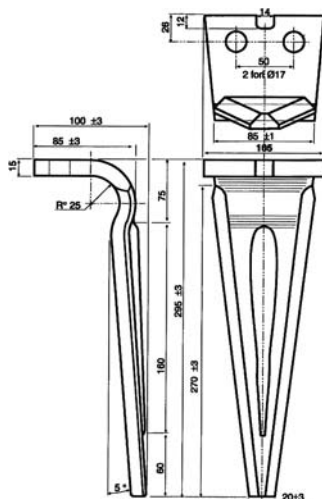

ARTICOLO	DESCRIZIONE
55945	Tipo pesante
MARCA	FORIGO

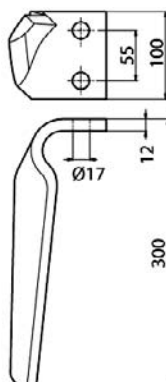

ARTICOLO	DESCRIZIONE
56904	Destro - Piatto 100x12
56905	Sinistro - Piatto 100x12
MARCA	FRANDENT

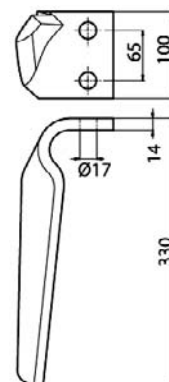

ARTICOLO	DESCRIZIONE
56908	Destro - Piatto 100x14
56909	Sinistro - Piatto 100x14
MARCA	FRANDENT

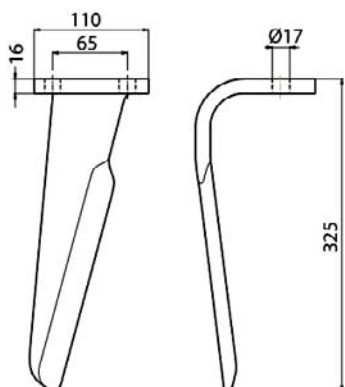

Il disegno rappresenta il particolare Dx

ARTICOLO	DESCRIZIONE
56906	Destro - Pesante
56907	Sinistro - Pesante
MARCA	FRANDENT

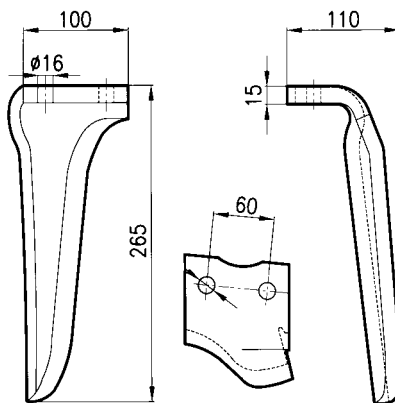

Il disegno rappresenta il particolare Dx

ARTICOLO	DESCRIZIONE
56516	Destro - 185516
56517	Sinistro - 185515
MARCA	HOWARD - R.

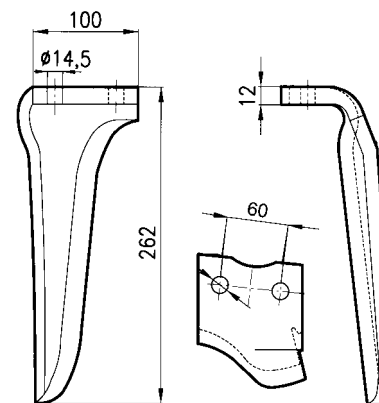

Il disegno rappresenta il particolare Dx

ARTICOLO	DESCRIZIONE
56518	Destro - 182936
56519	Sinistro - 182935
MARCA	HOWARD - R.

Zappe - Coltelli - Denti - Lame - Molle

BLADES - SPARE TINES FOR ROTARY HARROWS - CULTIVATOR SPRINGS

03

03

segue DENTI PER ERPICE ROTANTE

DENTS POUR HERSE ROTATIVE - TINES FOR ROTARY HARROWS - ZINKE FÜR EGGEN - DIENTES PARA GRADA RODANTE

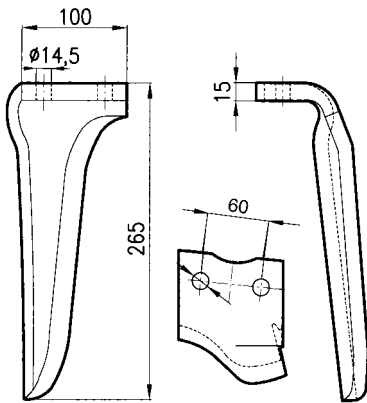

Il disegno rappresenta il particolare Dx

ARTICOLO	DESCRIZIONE
56520	Destro - 182938
56521	Sinistro - 182937
MARCA	HOWARD - R.

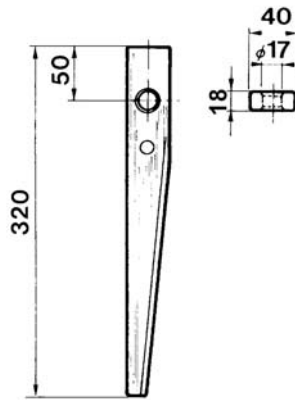

ARTICOLO	DESCRIZIONE
55071	Tipo corto
MARCA	KUHN

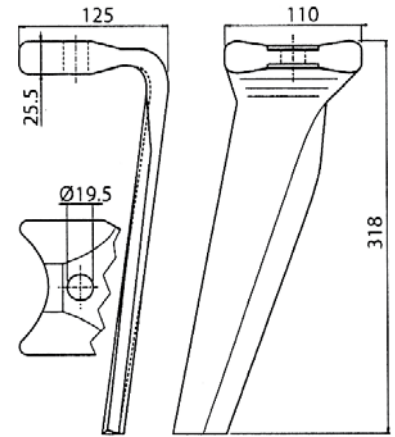

Il disegno rappresenta il particolare Dx

ARTICOLO	DESCRIZIONE
57199	ATTACCO RAPIDO - Destro
57200	ATTACCO RAPIDO - Sinistro
MARCA	KUHN (525.964.00+525.965.00)

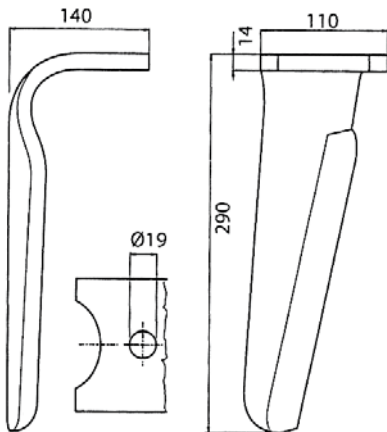

Il disegno rappresenta il particolare Dx

ARTICOLO	DESCRIZIONE
57201	ATTACCO RAPIDO - Dx - K2500081
57202	ATTACCO RAPIDO - Sx - K2500071
MARCA	KUHN

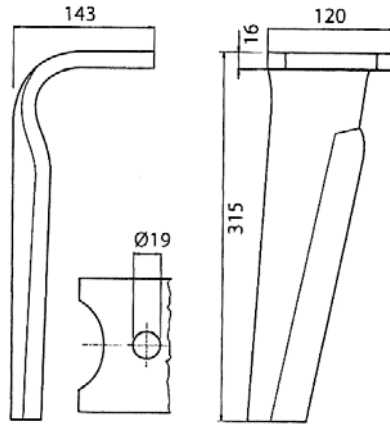

Il disegno rappresenta il particolare Dx

ARTICOLO	DESCRIZIONE
57204	ATTACCO RAPIDO - Dx - K2500100
57203	ATTACCO RAPIDO - Sx - K2500090
MARCA	KUHN

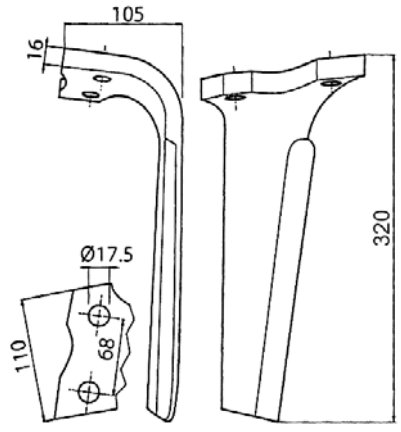

Il disegno rappresenta il particolare Dx

ARTICOLO	DESCRIZIONE	OEM
55947	Destro	52539400
55948	Sinistro	52539500
MARCA	KUHN	

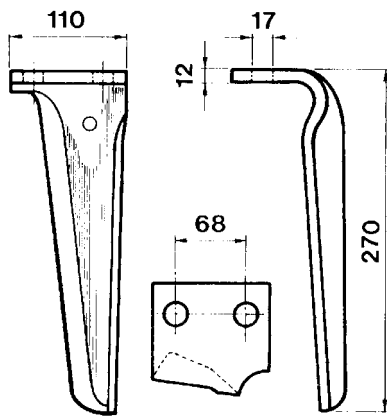

Il disegno rappresenta il particolare Sx

ARTICOLO	DESCRIZIONE
55949	Destro 52549400
55950	Sinistro 52549500
MARCA	KUHN

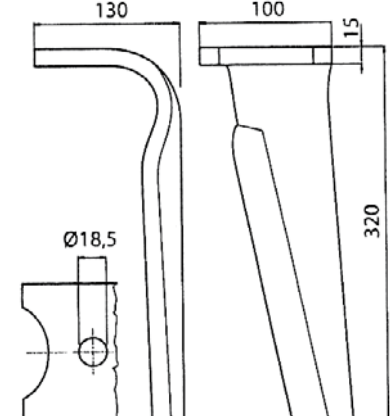

Il disegno rappresenta il particolare Sx

ARTICOLO	DESCRIZIONE
57205	ATTACCO RAPIDO - Dx - 46010150
57206	ATTACCO RAPIDO - Sx - 46010151
MARCA	KVERNELAND - MALETTI

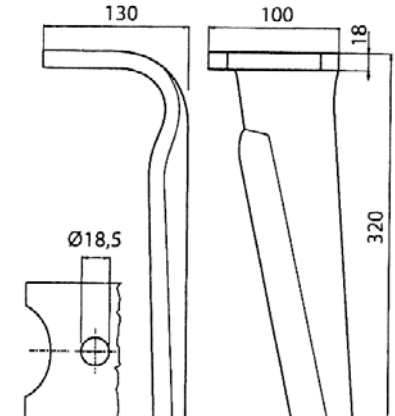

Il disegno rappresenta il particolare Sx

ARTICOLO	DESCRIZIONE
57207	ATTACCO RAPIDO - Dx - 44010150
57208	ATTACCO RAPIDO - Sx - 44010151
MARCA	KVERNELAND - MALETTI

segue DENTI PER ERPICE ROTANTE

DENTS POUR HERSE ROTATIVE - TINES FOR ROTARY HARROWS - ZINKE FÜR EGGEN - DIENTES PARA GRADA RODANTE

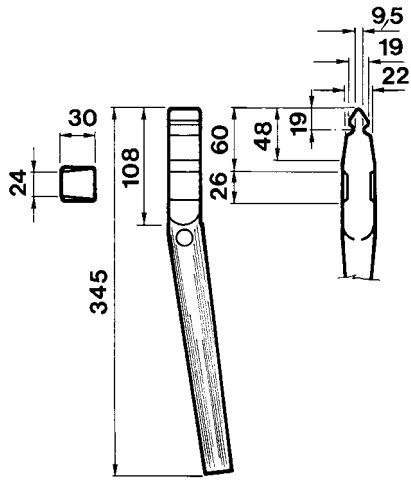

ARTICOLO	DESCRIZIONE
55156	Quadro 30x30 mm
MARCA	KVERNELAND - MALETTI

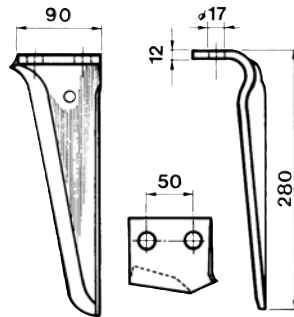

Il disegno rappresenta il particolare Sx

ARTICOLO	DESCRIZIONE
55084	Destro - Piatto 90x12 mm
55085	Sinistro - Piatto 90x12 mm
MARCA	KVERNELAND - MALETTI

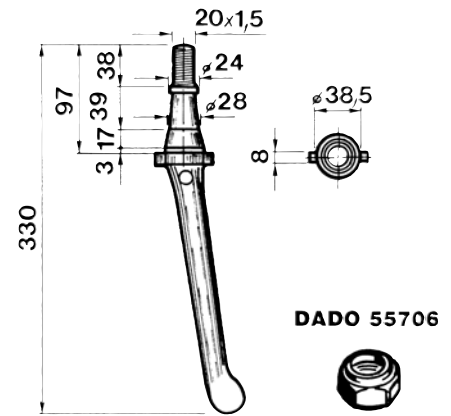

ARTICOLO	DESCRIZIONE
55074	Conico con punta a goccia
MARCA	LELY

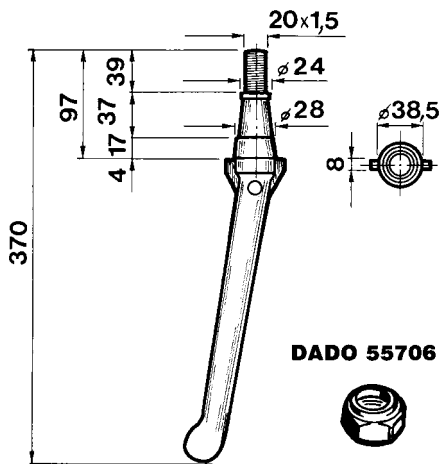

ARTICOLO	DESCRIZIONE
55075	Conico con punta a goccia
MARCA	LELY (1.1632.1487.0)

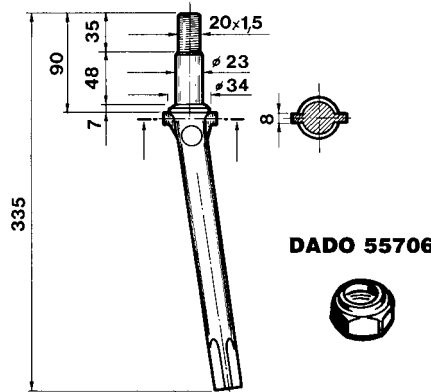

ARTICOLO	DESCRIZIONE
55079	Clindrico 1° tipo
MARCA	LELY

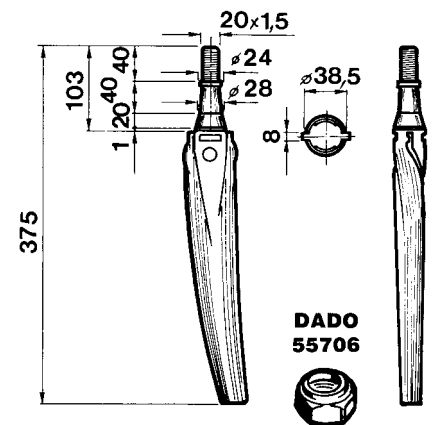

ARTICOLO	DESCRIZIONE
55076	Conico a coltello Dx
55077	Conico a coltello Sx
MARCA	LELY

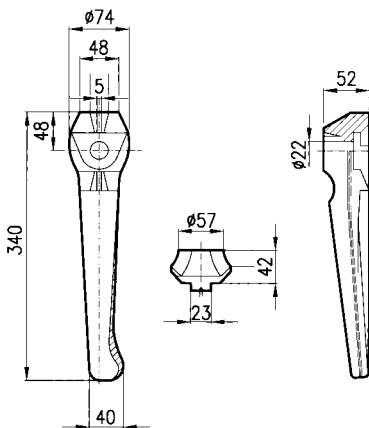

ARTICOLO	DESCRIZIONE
56527	Standard destro
56528	Standard sinistro
MARCA	LELY CLUB A GOCCIA

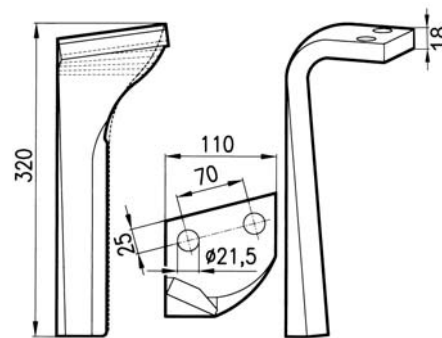

Il disegno rappresenta il particolare Dx

ARTICOLO	DESCRIZIONE
56529	Destro - 3377013
56530	Sinistro - 3377012
MARCA	LEMKEN

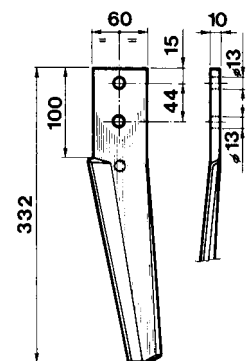

ARTICOLO	DESCRIZIONE
55250	Destro - Piatto 60x10 mm
55654	Sinistro - Piatto 60x10 mm
MARCA	MASCHIO, CELLI, FALC, FORIGO, MALETTI, MORENI, SIGMA, PEGORARO, VIGOLO

Zappe - Coltelli - Denti - Lame - Molle

BLADES - SPARE TINES FOR ROTARY HARROWS - CULTIVATOR SPRINGS

03

03

segue DENTI PER ERPICE ROTANTE

DENTS POUR HERSE ROTATIVE - TINES FOR ROTARY HARROWS - ZINKE FÜR EGGEN - DIENTES PARA GRADA RODANTE

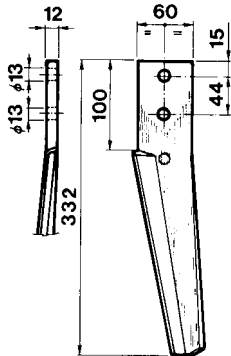

ARTICOLO	DESCRIZIONE
55251	Destro - Piatto 60x12 mm
55655	Sinistro - Piatto 60x12 mm
MARCA	MASCHIO: ROTOR FRESA - HB - HM - HL (10 100262+10100263/10100225+10100226) MORENI: RH60

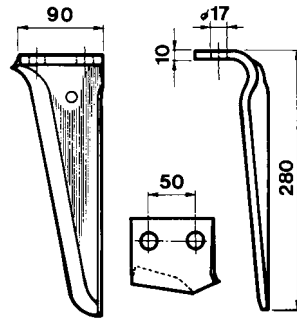

Il disegno rappresenta il particolare Sx

ARTICOLO	DESCRIZIONE
55252	Coltello Dx - Piatto 90x10 mm
55656	Coltello Sx - Piatto 90x10 mm
MARCA	MASCHIO: DC - DS - DL (27100209+27100210) CELLI, FALC, FORIGO, MALETTI, MORENI, SICMA, PEGORARO, VIGOLO

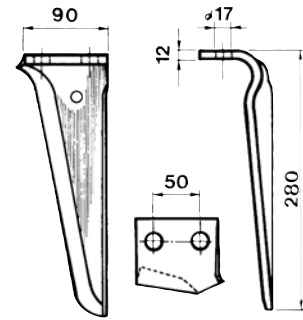

Il disegno rappresenta il particolare Sx

ARTICOLO	DESCRIZIONE	OEM
55084	Diamante Dx-P.90x12	M27100210R
55085	Diamante Sx-P.90x12	M27100209S
MARCA	MASCHIO: DC - DS - DL - GABBIANO - FALCO (38100222+38100223) FORIGO, PEGORARO, SICMA	

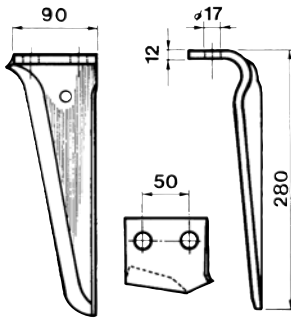

Il disegno rappresenta il particolare Sx

ARTICOLO	DESCRIZIONE	OEM
57450	Diamante Dx-P.90x12	M27100210R
57451	Diamante Sx-P.90x12	M27100209R
MARCA	MASCHIO (ORIGINALE)	

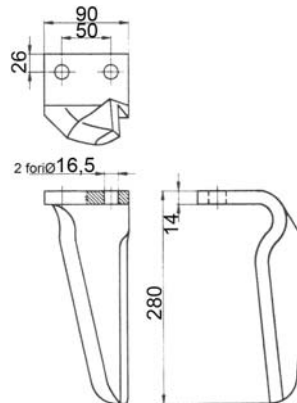

Il disegno rappresenta il particolare Sx

ARTICOLO	DESCRIZIONE	OEM
57492	DC NT pesante Dx.	38100222
57491	DC NT pesante Sx.	38100223
MARCA	MASCHIO	

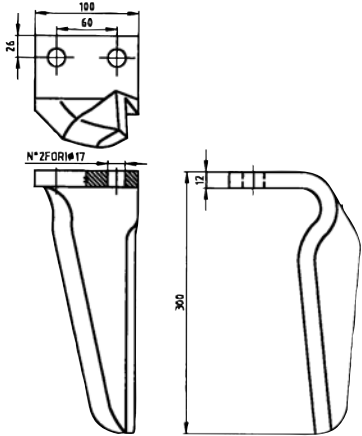

Il disegno rappresenta il particolare Sx

ARTICOLO	DESCRIZIONE	OEM
55086	Dominator Dx	36100210
55090	Dominator Sx	36100211
MARCA	MASCHIO: DM - AQUILA	

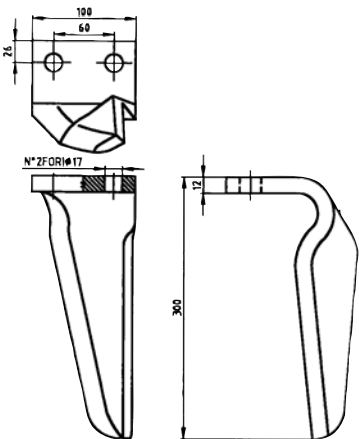

Il disegno rappresenta il particolare Sx

ARTICOLO	DESCRIZIONE	OEM
57452	Dominator Dx	36100210R
57453	Dominator Sx	36100211R
MARCA	MASCHIO (ORIGINALE)	

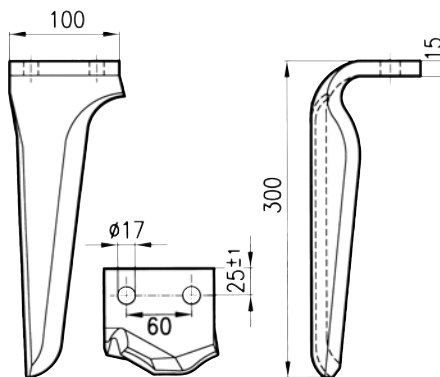

Il disegno rappresenta il particolare Dx

ARTICOLO	DESCRIZIONE
56535	Dominator Dx - Rinforzato
56536	Dominator Sx - Rinforzato
MARCA	MASCHIO (ORIGINALE): DM - AQUILA (36100215 / 36100216) FERABOLI FN, PEGORARO PESANTE

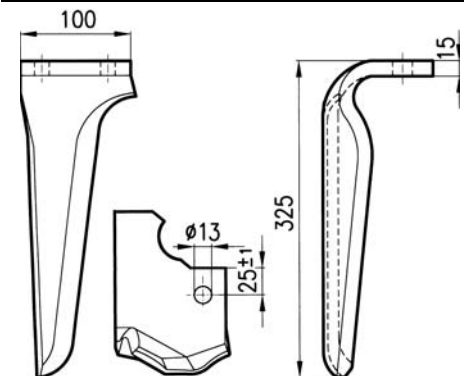

Il disegno rappresenta il particolare Dx
OEM: M36100366R / M36100367R

ARTICOLO	DESCRIZIONE
57447	Coltello Dx - Sgancio rapido 100x15
57448	Coltello Sx - Sgancio rapido 100x15
MARCA	MASCHIO (ORIGINALE): DM - AQUILA - MEGA - TORO - JUMBO - ORSO

segue DENTI PER ERPICE ROTANTE

DENTS POUR HERSE ROTATIVE - TINES FOR ROTARY HARROWS - ZINKE FÜR EGGEN - DIENTES PARA GRADA RODANTE

CUSCINETTO OSCILLANTE H42

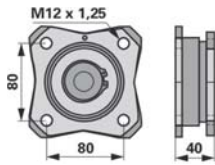

ARTICOLO	DESCRIZIONE	OEM
57454	Cuscinetto oscillante H42	M43400467R
MARCA	MASCHIO (ORIGINALE)	

SUPPORTO RULLO H60

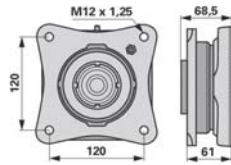

ARTICOLO	DESCRIZIONE	OEM
57493	Supporto cuscinetto oscillante H60	M43400468R
MARCA	MASCHIO (ORIGINALE)	

SUPPORTO COMPLETO LATERALE E CENTRALE



ARTICOLO	DESCRIZIONE	OEM
57494	Supporto completo laterale e centrale	M38100907R
MARCA	MASCHIO (ORIGINALE)	

PROTEZIONE PER DENTE

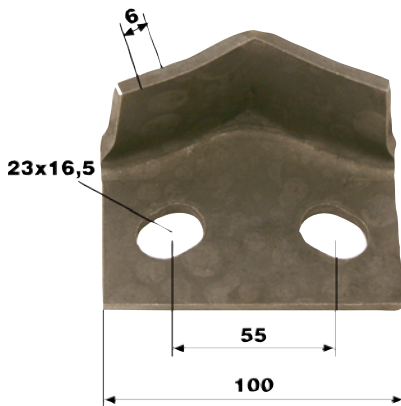

ARTICOLO	DESCRIZIONE	OEM
55798	DM - DC - DL - DS	38100215

FERMO VITE

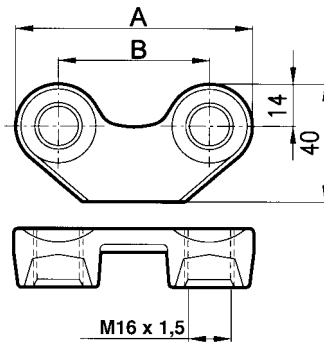

ARTICOLO	A	B	PER ARTICOLI	OEM
56537	88	60	55086 - 55090 56535 - 56536	36100312
56538	78	50	55084 - 55085 55252 - 55656	38100218
57095	Vite M16x1,5 L.55 - CLASSE 10.9			

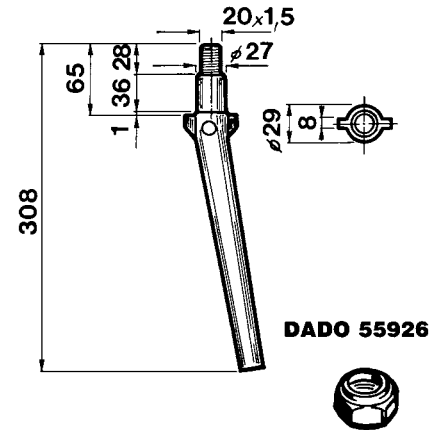

ARTICOLO	DESCRIZIONE
55092	Conico
MARCA	MORENI

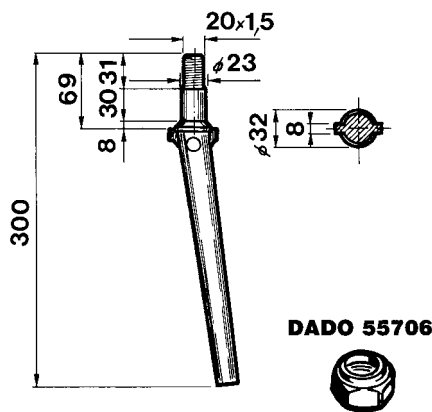

ARTICOLO	DESCRIZIONE
55091	Clindrico
MARCA	MORENI

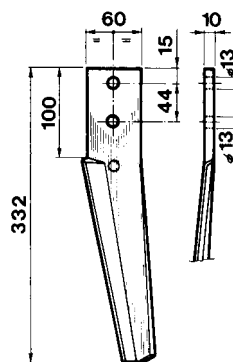

ARTICOLO	DESCRIZIONE
55250	Destro - Piatto 60x10 mm
55654	Sinistro - Piatto 60x10 mm
MARCA	MORENI

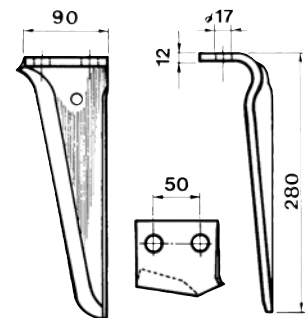

ARTICOLO	DESCRIZIONE
55084	Destro - Piatto 90x12 mm
55085	Sinistro - Piatto 90x12 mm
MARCA	MORENI

Zappe - Coltelli - Denti - Lame - Molle

BLADES - SPARE TINES FOR ROTARY HARROWS - CULTIVATOR SPRINGS

03

03

segue DENTI PER ERPICE ROTANTE

DENTS POUR HERSE ROTATIVE - TINES FOR ROTARY HARROWS - ZINKE FÜR EGGEN - DIENTES PARA GRADA RODANTE

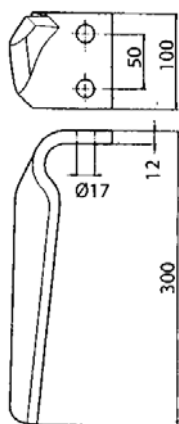

ARTICOLO	DESCRIZIONE
57140	Destro
57141	Sinistro
MARCA	MORENI

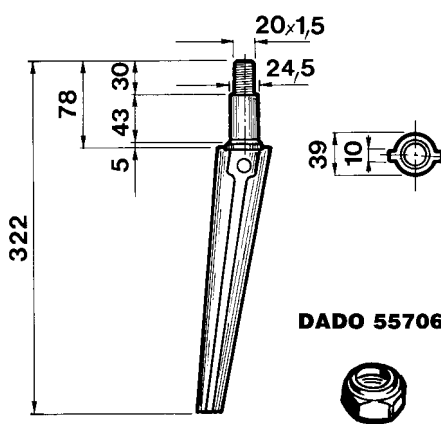

ARTICOLO	DESCRIZIONE
55063	Cilindrico corto
MARCA	MORRA - GEO ROTOR

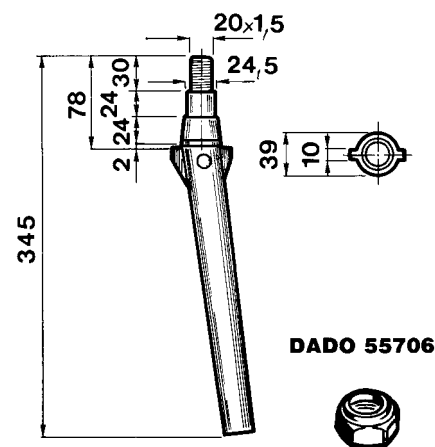

ARTICOLO	DESCRIZIONE
55925	Conico
MARCA	MORRA - GEO ROTOR

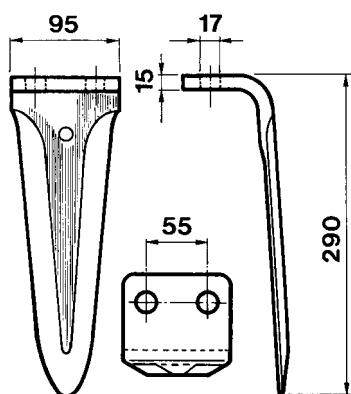

ARTICOLO	DESCRIZIONE
55946	Tipo pesante
MARCA	MORRA - GEO ROTOR

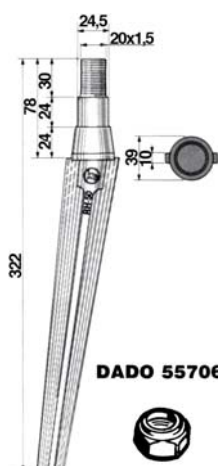

ARTICOLO	DESCRIZIONE
57144	Conico
MARCA	MORRA - GEO ROTOR

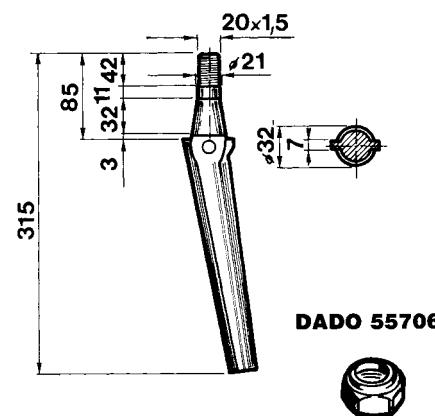

ARTICOLO	DESCRIZIONE
55131	Conico
MARCA	O.M.C.A., ASCOT, FORIGO, ISOMEK, REMAC, SLAM

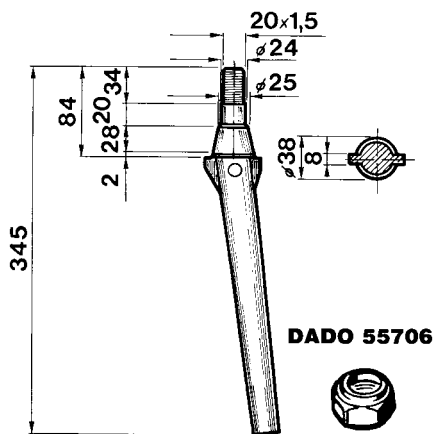

ARTICOLO	DESCRIZIONE
55093	Conico
MARCA	PEDROTTI

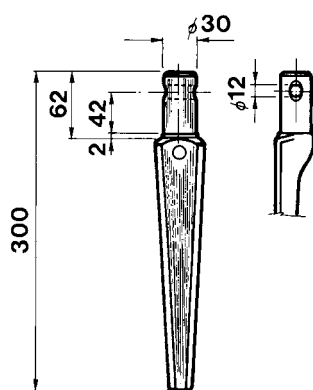

ARTICOLO	DESCRIZIONE
OEM 003981	
55095	Mod. RC - Gambo Ø 30 mm
MARCA	PEGORARO (003981.01)

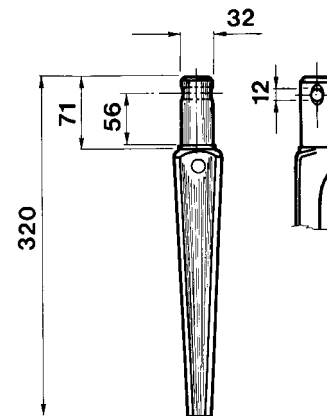

ARTICOLO	DESCRIZIONE
OEM 006100	
55094	Mod. RD - Gambo Ø 32 mm
MARCA	PEGORARO

segue DENTI PER ERPICE ROTANTE

DENTS POUR HERSE ROTATIVE - TINES FOR ROTARY HARROWS - ZINKE FÜR EGGEN - DIENTES PARA GRADA RODANTE

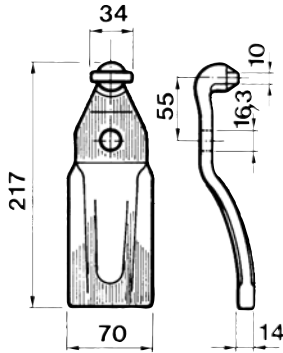

OEM 006955/2

ARTICOLO	DESCRIZIONE
55958	Pegolama a 1 foro
MARCA	PEGORARO

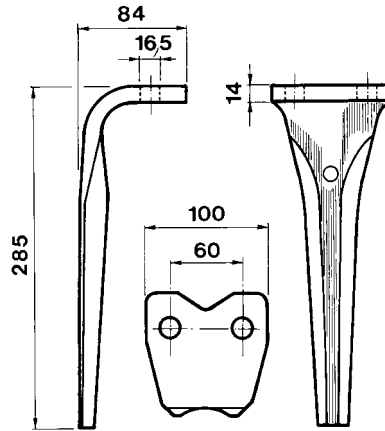

OEM 008555

ARTICOLO	DESCRIZIONE
55959	Unidirezionale - 100x14 mm
MARCA	PEGORARO

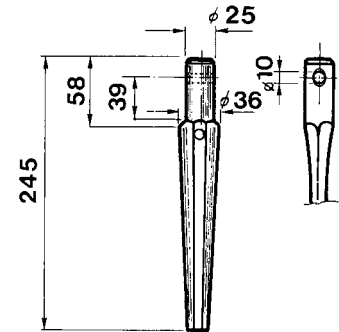

OEM 001205

ARTICOLO	DESCRIZIONE
55096	Mod. RA - Gambo Ø 25 mm
MARCA	PEGORARO

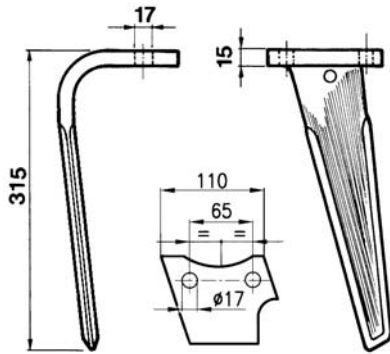

OEM 84045001/84045002

ARTICOLO	DESCRIZIONE
55105	Mod. KG 30 - Dx piatto 100x15 mm
55106	Mod. KG 30 - Sx piatto 100x15 mm
MARCA	PERUGINI

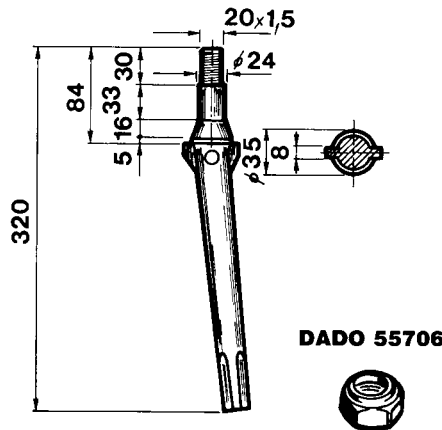

DADO 55706

ARTICOLO	DESCRIZIONE
55022	Conico
MARCA	PERUGINI, CELLI

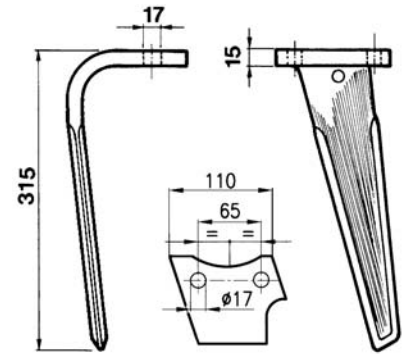

Il disegno rappresenta il particolare Dx

ARTICOLO	DESCRIZIONE
55105	Mod. KG 30 - Dx piatto 100x15 mm
55106	Mod. KG 30 - Sx piatto 100x15 mm
MARCA	RABEWERK

new

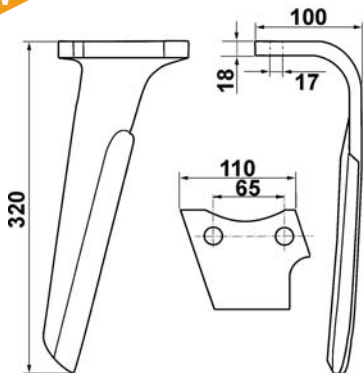

piatto 100x18 mm

Il disegno rappresenta il particolare Dx

ARTICOLO	DESCRIZIONE
57557	Dx - KG30 (84231801) KG41 (8404501)
57558	Sx - KG30 (84231803) KG41 (8404502)
MARCA	RABEWERK

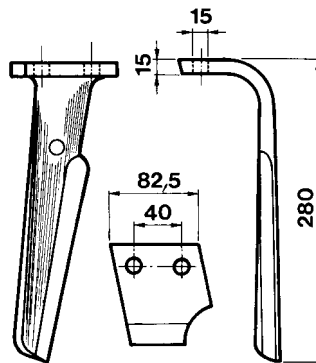

OEM 84091201/84091202

ARTICOLO	DESCRIZIONE
55966	Mod. KG 26 - Dx piatto 82,5x15 mm
55967	Mod. KG 26 - Sx piatto 82,5x15 mm
MARCA	RABEWERK

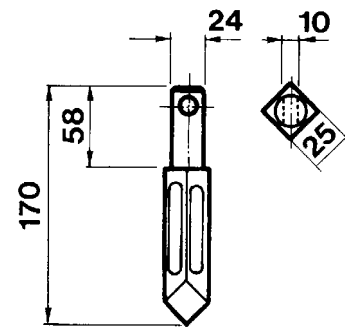

ARTICOLO	DESCRIZIONE
55146	Mod. "Rototiller" - Gambo Ø 24 mm
MARCA	RAU (R40023374)

Zappe - Coltelli - Denti - Lame - Molle

BLADES - SPARE TINES FOR ROTARY HARROWS - CULTIVATOR SPRINGS

03

03

segue DENTI PER ERPICE ROTANTE

DENTS POUR HERSE ROTATIVE - TINES FOR ROTARY HARROWS - ZINKE FÜR EGGEN - DIENTES PARA GRADA RODANTE

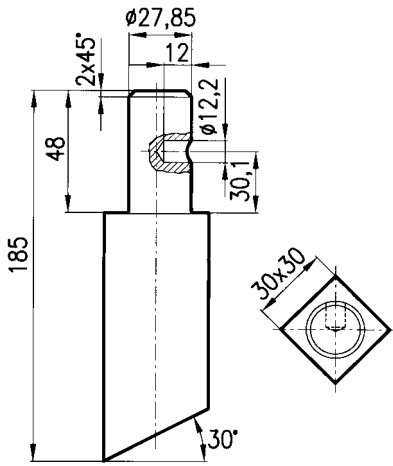

ARTICOLO	DESCRIZIONE
56544	Gambo 28 - Quadro 30x30 mm
MARCA	RAU

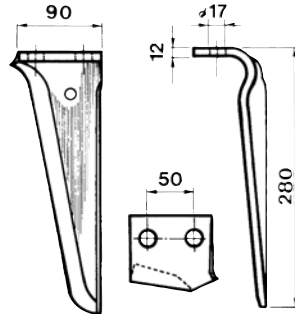

ARTICOLO	DESCRIZIONE
55084	Destro - Piatto 90x12 mm
55085	Sinistro - Piatto 90x12 mm
MARCA	RAU

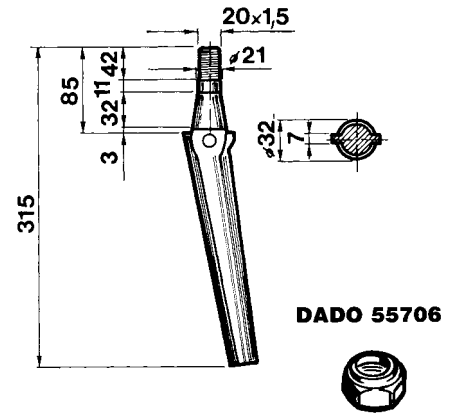

ARTICOLO	DESCRIZIONE
55131	Conico
MARCA	REMAC

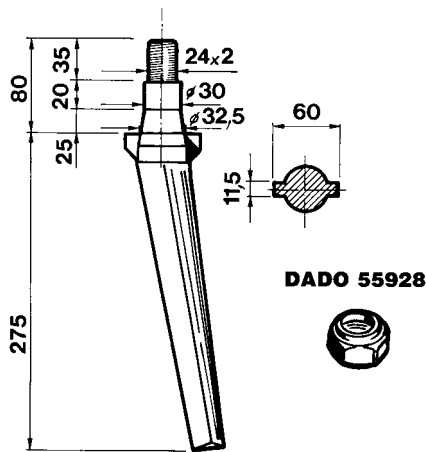

ARTICOLO	DESCRIZIONE
55129	Conico pesante
MARCA	O.M.C.A., ASCOT, ISOMEC, REMAC

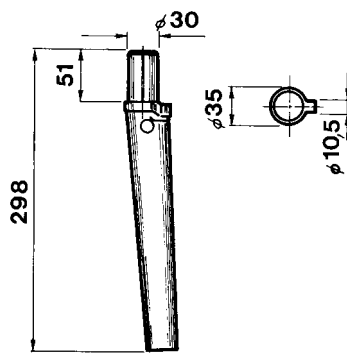

ARTICOLO	DESCRIZIONE
55137	Modello LS
MARCA	O.M.C.A., ASCOT, ISOMEC, REMAC

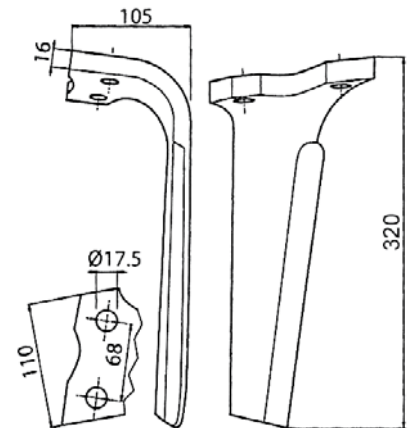

ARTICOLO	DESCRIZIONE
55947	Destro - Piatto 110x16 mm
55948	Sinistro - Piatto 110x16 mm
MARCA	REMAC - SCHWARZ

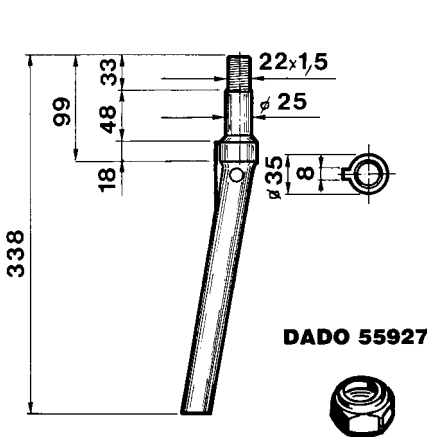

ARTICOLO	DESCRIZIONE
55155	Cilindrico
MARCA	SEIMA

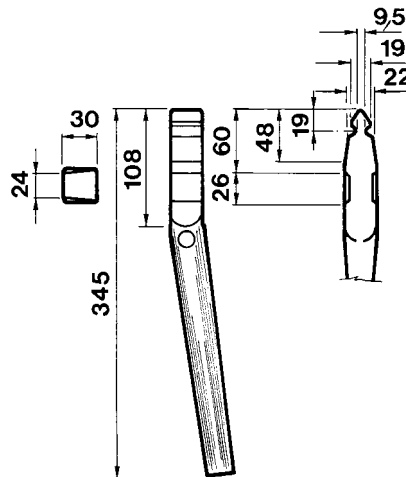

ARTICOLO	DESCRIZIONE
55156	Quadro 30x30 mm
MARCA	SICMA, MALETTI

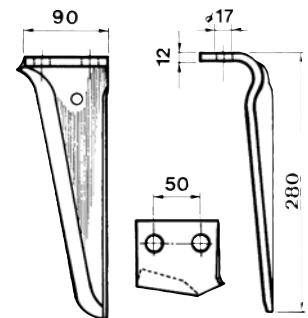

ARTICOLO	DESCRIZIONE
55084	Destro - Piatto 90x12 mm
55085	Sinistro - Piatto 90x12 mm
MARCA	VIGOLO

segue DENTI PER ERPICE ROTANTE

DENTS POUR HERSE ROTATIVE - TINES FOR ROTARY HARROWS - ZINKE FÜR EGGEN - DIENTES PARA GRADA RODANTE

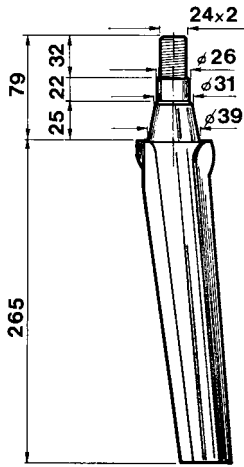

DADO 55928



ARTICOLO	DESCRIZIONE
55164	Conico piatto
MARCA	VIGOLO, SOVEMA

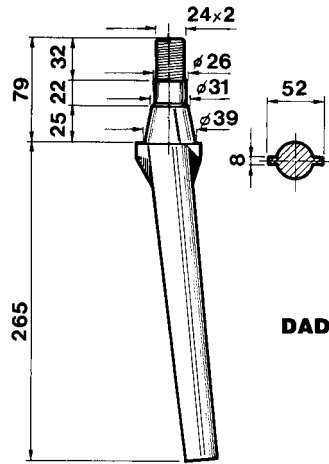

DADO 55928



ARTICOLO	DESCRIZIONE
55160	Conico
MARCA	VIGOLO, SOVEMA

Zappe - Coltelli - Denti - Lame - Molle

BLADES - SPARE TINES FOR ROTARY HARROWS - CULTIVATOR SPRINGS

03

03

VITI E DADI PER ERPICE ROTANTE

VIS ET ECROUS POUR HERSE ROTATIVE - BOLTS AND NUTS FOR ROTARY HARROWS - SCHRAUBEN UND MUTTERN FÜR KREISELEGGE - TORNILLOS Y TUERCAS GRADA ROTATIVA

VITE CLASSE 10.9

VIS 10.9
BOLT 10.9
SCHRAUBE 10.9
TORNILLO 10.9

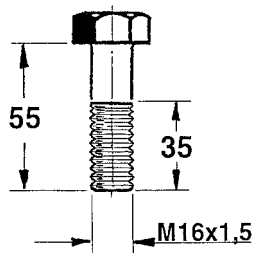

DADO AUTOBLOCCANTE ALTO

ECROU DE SURETÉ HAUT
THICK SELF-LOCKING NUT
SELBSTSPERRENDE MUTTER, HOCH
TUERCA AUTOBLOCANTE GRUESA

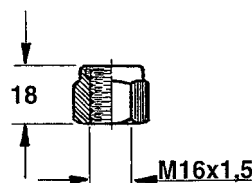

ARTICOLO	APPLICAZIONE
57095	MASCHIO - CELLI - PERUGINI - KUHN

ARTICOLO	APPLICAZIONE
56202	CELLI - PERUGINI

DADI PER DENTI ERPICI ROTANTI

ECROUS POUR DENTS HERSES ROTATIVES
NUTS FOR ROTARY HARROW TINES
MUTTERN FÜR KREISELEGGENZINKEN
TUERCAS PARA DIENTES GRADAS ROTATIVAS



ARTICOLO	DESCRIZIONE
56202	Autoblocc. M16x1,5
55926	Autoblocc. M20x1,5x17
55706	Autoblocc. M20x1,5x22
55927	Autoblocc. M22x1,5x18
55928	Autoblocc. M24x2x21

KIT VITE CON DADO PER ERPICE FERABOLI - CLASSE 10.9

KIT VIS AVEC ÉCROU POUR HERSE FERABOLI - CLASSE 10.9
SCREW KIT WITH NUT FOR FERABOLI HARROW - CLASS 10.9
KIT SCHRAUBE MIT MUTTER FÜR FERABOLI EGGEN - KLASSE 10.9
KIT TORNILLO CON TUERCA PARA GRADA FERABOLI - CLASE 10.9

new

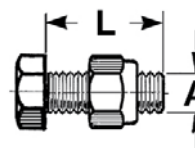

ARTICOLO	A	L mm	APPLICAZIONE	OEM
57587	M16x1,5	45	FERABOLI: Master - Vector	0241645
57588	M20x1,5	55	FERABOLI	0242055

DENTI PER ERPICE TIPO QUADRO

DENTS POUR HERSE TYPE CARRÉ
HARROW TINES - SQUARE TYPE
ZINKEN FÜR EGGEN VIERKANTTYP
DIENTES PARA GRADA TIPO CUADRADO

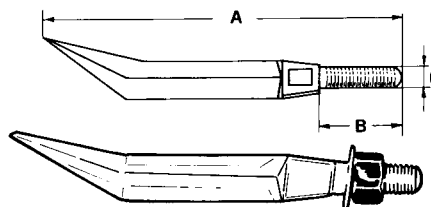

ARTICOLO	TIPO	A mm	B mm	FILETTATURA	QUADRO mm
55729	3	250	50	16MA	20x24
55699	4	280	60	20MA	24x26
55700	5	307	65	20MA	24x26
55701	6	307	65	22MA	24x26
55702	8	350	70	24MA	32x32

DISCHI FRANGIZOLLE MATERIALE BORO 30 MNB 5

DISQUES PULVERISEURS - DISCS - SCHEIBEN - PLATOS DESTERRONADORES



DISCO LISCIO - QUADRO CENTRALE

ARTICOLO	Ø mm	QUADRO mm	SPESSORE mm	CONCAVITÀ	PESO kg
55886	410	26	3,2	39	3,5
55887	460	26	3,2	49	4,4
55888	510	26	3,5	61	5,8
55889	560	26	4,5	72	8,2
55425	510	31	3,5	61	5,8
55383	560	31	4,5	72	8,2
55431	610	31	5,0	84	11,6
57483	610	33	5,0	73	11,6
57485	610	33	6,0	73	14,1
56356	560	41	6,0	72	11,6
56392	610	41	6,0	84	12,0
56366	610	41	5,0	84	12,0
56390	660	41	6,0	100	17,0
57487	660	42	6,0	87	17,2



DISCO DENTATO - QUADRO CENTRALE

ARTICOLO	Ø mm	QUADRO mm	SPESSORE mm	CONCAVITÀ	PESO kg
55892	410	26	3,2	39	3,0
55893	460	26	3,2	49	3,6
55894	510	26	3,5	61	5,2
55895	560	26	4,5	72	7,2
55424	510	31	3,5	61	5,2
55411	560	31	4,5	72	7,9
55430	610	31	5,0	84	10,5
57484	610	33	5,0	73	1,05
57486	610	33	6,0	73	12,7
56357	560	41	6,0	72	10,5
56393	610	41	6,0	84	11,0
56379	610	41	5,0	84	11,0
56391	660	41	6,0	100	15,5
57488	660	42	6,0	87	15,5

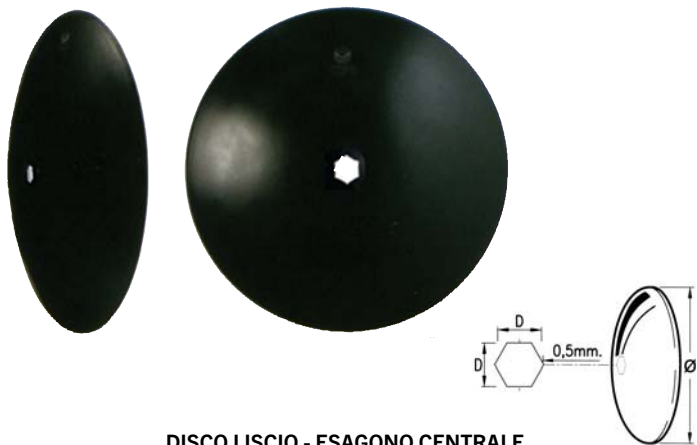

DISCO LISCIO - ESAGONO CENTRALE

ARTICOLO	Ø mm	ESAGONO mm	SPESSORE mm	CONCAVITÀ	PESO kg
57477	460	37	3,5	74	4,8
55432	510	37	3,5	61	5,8
55442	560	37	4,5	78	9,0
55891	610	37	5,0	84	11,6
57479	610	37	6,0	73	14,1
57481	660	37	6,0	87	17,2
55437	510	67	3,5	61	5,8
55443	560	67	4,5	72	9,0
55896	610	67	5,0	84	11,6
55438	510	92	3,5	61	5,8
55444	560	92	4,5	72	9,0
55897	610	92	5,0	84	11,6



DISCO DENTATO - ESAGONO CENTRALE

ARTICOLO	Ø mm	ESAGONO mm	SPESSORE mm	CONCAVITÀ	PESO kg
57478	460	37	3,5	74	4,0
55423	510	37	3,5	61	5,2
55439	560	37	4,5	78	7,9
55445	610	37	5,0	84	10,5
57480	610	37	6,0	73	12,7
57482	660	37	6,0	87	15,5
55428	510	67	3,5	61	5,2
55440	560	67	4,5	72	7,9
55446	610	67	5,0	84	10,5
55429	510	92	3,5	61	5,2
55441	560	92	4,5	72	7,9
55890	610	92	5,0	61	10,5

segue DISCHI FRANGIZOLLE MATERIALE BORO 30 MNB 5
DISQUES PULVERISEURS - DISCS - SCHEIBEN - PLATOS DESTERRONADORES

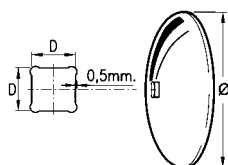

DISCO ONDULATO - QUADRO CENTRALE

ARTICOLO	Ø mm	QUADRO mm	SPESSORE mm	CONCAVITÀ	PESO kg
55898	470	31	4	Ondulato	5,5
55900	510	31	4	Ondulato	7,5
55899	470	41	4	Ondulato	5,5
55901	510	41	4	Ondulato	7,5

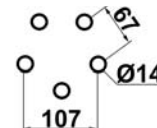
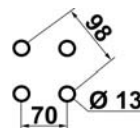

DISCO DENTATO PER MOZZI A 4 E 5 FORI

ARTICOLO	Ø mm	NUMERO FORI	SPESSORE mm	PIANO CENTRALE	PESO kg
55904	460	4	4	130	3,90
55905	510	4	4	130	7,50
57672	560	4	5	130	10,30
56155	560	5	6	170	10,30
56156	610	5	6	170	12,70

DISCHI ARATRO - VERDEGIGLIO (fori cilindrici)
DISQUES VERDEGIGLIO - DISCS VERDEGIGLIO - SCHEIBEN VERDEGIGLIO - PLATOS VERDEGIGLIO

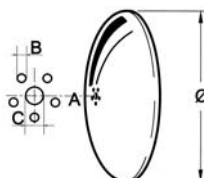
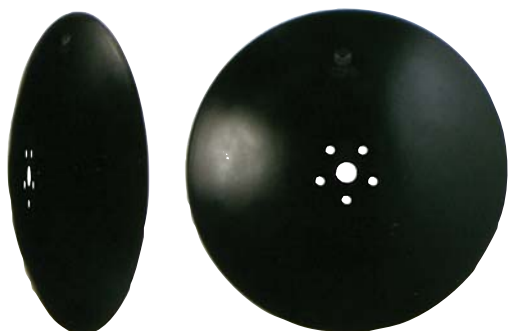

FORATURA CENTRALE

ARTICOLO	Ø mm	Ø FORO CENTRALE mm C	N° FORI PERIFERICI	Ø FORI PERIFERICI mm B	SPESSORE mm	CONCAVITÀ	INTERASSE mm A
56378	560	26	5	13	6	71	210
55433	560	30	5	13	6	71	155
56371	610	26	5	13	6	84	210
56389	610	30	5	13	6	84	155
56372	660	26	5	15	6	100	260
56373	710	26	5	15	6	120	260

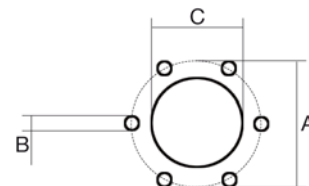
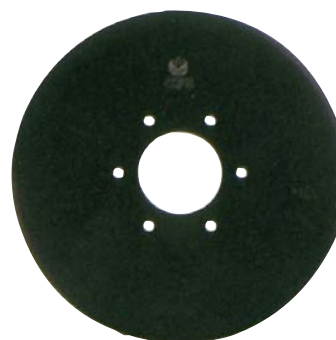

DISCHI PIATTI PER ARATRO

ARTICOLO	Ø mm	Ø FORO CENTRALE mm C	N° FORI PERIFERICI	Ø FORI PERIFERICI mm B	SPESSORE mm	INTERASSE mm A
55434	400	110	6	13	7	165
55435	450	110	6	13	7	165
55436	500	110	6	13	7	165

SUPPORTO PER DISCHI FRANGIZOLLA A 4 E 5 FORI

SUPPORT DISQUES BRISE-MOTTE A 4 ET 5 TROUS - SUPPORT FOR DISK HARROWS WITH 4 AND 5 HOLES
 TRÄGER FÜR SCHOLLENBRECHRÄDER MIT 4 UND 5 LÖCHERN - SOPORTE PARA PLATOS DESTERRONADORES DE 4 Y 5 AGUJEROS



Le foto della pagina rappresentano la Versione Anteriore

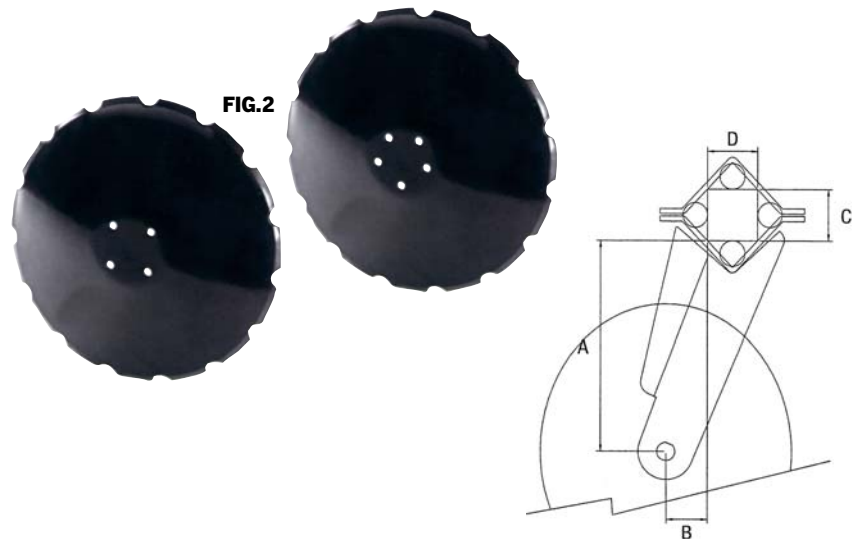
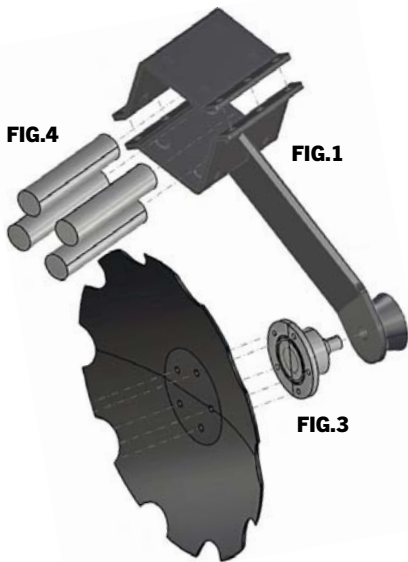

QUATTRO FORI - TELAIO 80x80 mm

DIMENSIONI		SUPPORTO	SILENT BLOCK
A mm	B mm	C/D mm	mm
330	65	80 x 80	40 x 230

CINQUE FORI - TELAIO 100x100 mm

DIMENSIONI		SUPPORTO	SILENT BLOCK
A mm	B mm	C/D mm	mm
390	40	100 x 100	50 x 240

ARTICOLO	DESCRIZIONE	FIGURA
55902	Supporto Anteriore telaio 80x80	1
55903	Supporto Posteriore telaio 80x80	1
55904	Disco dentato Ø460x4 mm a 4 fori	2
55905	Disco dentato Ø510x4 mm a 4 fori	2
57672	Disco dentato Ø560x5 mm a 4 fori	2
55906	Mozzo per disco 4 Fori	3
55907	Silentblock 40x230 mm per supporto	4

ARTICOLO	DESCRIZIONE	FIGURA
55908	Supporto Anteriore telaio 100x100	1
55909	Supporto Posteriore telaio 100x100	1
56155	Disco dentato Ø560x6 mm a 5 fori	2
56156	Disco dentato Ø610x6 mm a 5 fori	2
56354	Mozzo per disco 5 fori	3
56355	Silentblock 50x240 mm per supporto	4

Zappe - Coltelli - Denti - Lame - Molle

BLADES - SPARE TINES FOR ROTARY HARROWS - CULTIVATOR SPRINGS

03

03

SUPPORTI CUSCINETTI PER DISCHI FRANGIZOLLE

SUPPORTS ROULEMENTS POUR DISQUES ÉMOTTEUSE - BEARING HOLDERS FOR HARROW DISCS
LAGERAUFNAHME FÜR BRECHSCHEIBEN - SOPORTES COJINETES PARA GRADAS DE DISCOS

SUPPORTO A 4 FORI INTERASSE 98 mm

SUPPORT À 4 TROUS ENTRAXE 98 mm
4-HOLE 98mm DISTANCE BETWEEN CENTRES BRACKET
LAGERUNG MIT 4 BOHRUNGEN MIT ACHSABSTAND 98 mm
SOPORTE DE 4 ORIFICIOS DISTANCIA 98 mm

new

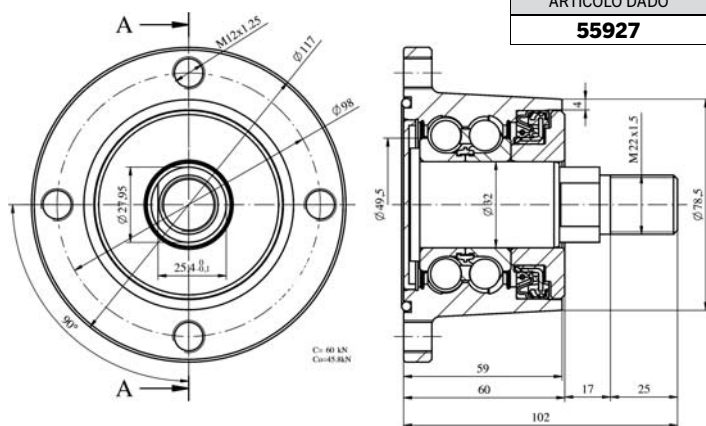

ARTICOLO DADO
55927

ARTICOLO
55906

SUPPORTO A 5 FORI INTERASSE 98 mm

SUPPORT À 5 TROUS ENTRAXE 98 mm
5-HOLE 98mm DISTANCE BETWEEN CENTRES BRACKET
LAGERUNG MIT 5 BOHRUNGEN MIT ACHSABSTAND 98 mm
SOPORTE DE 5 ORIFICIOS DISTANCIA 98 mm

new

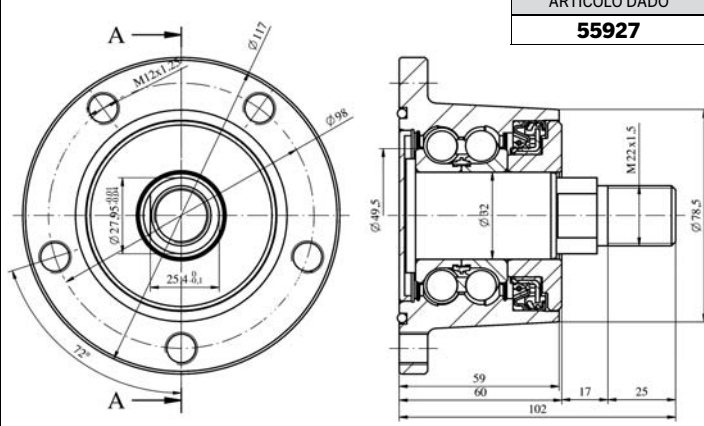

ARTICOLO DADO
55927

ARTICOLO
57589

SUPPORTO A 6 FORI INTERASSE 98 mm

SUPPORT À 6 TROUS ENTRAXE 98 mm
6-HOLE 98mm DISTANCE BETWEEN CENTRES BRACKET
LAGERUNG MIT 6 BOHRUNGEN MIT ACHSABSTAND 98 mm
SOPORTE DE 6 ORIFICIOS DISTANCIA 98 mm

new

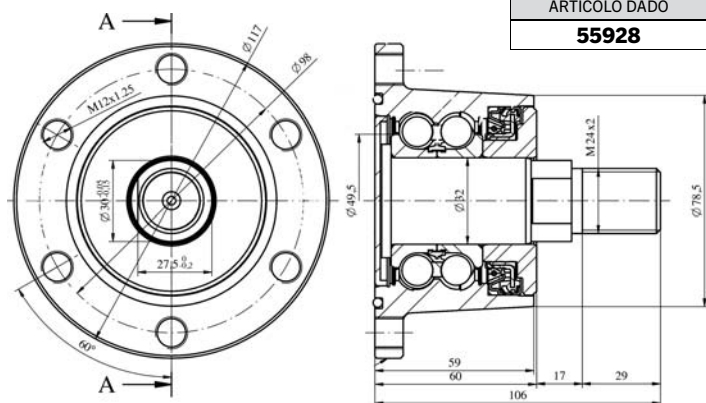

ARTICOLO DADO
55928

ARTICOLO
57590

SUPPORTO A 5 FORI INTERASSE 112 mm

SUPPORT À 5 TROUS ENTRAXE 112 mm
5-HOLE 112 mm DISTANCE BETWEEN CENTRES BRACKET
LAGERUNG MIT 5 BOHRUNGEN MIT ACHSABSTAND 112 mm
SOPORTE DE 5 ORIFICIOS DISTANCIA 112 mm

new

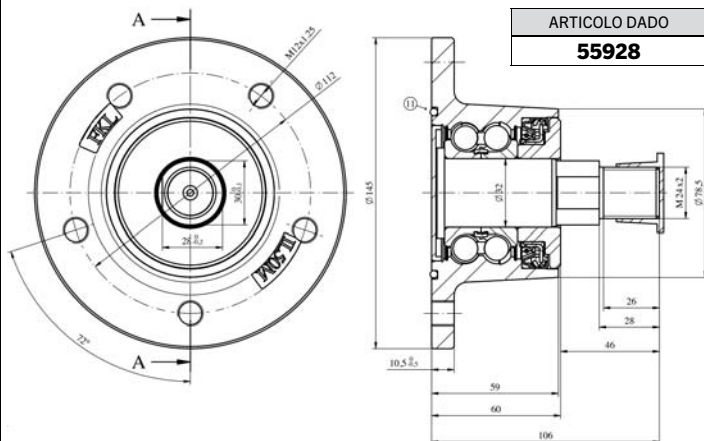

ARTICOLO DADO
55928

ARTICOLO
56354

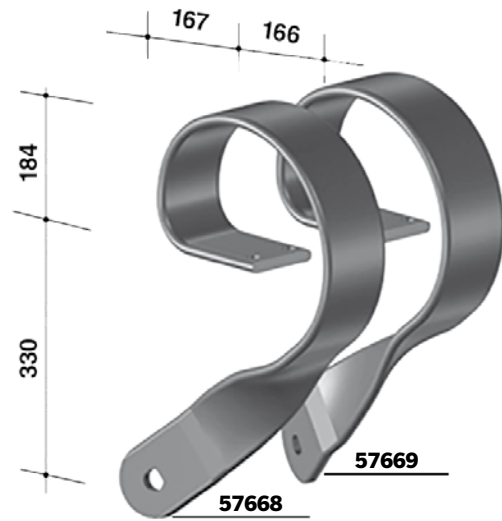
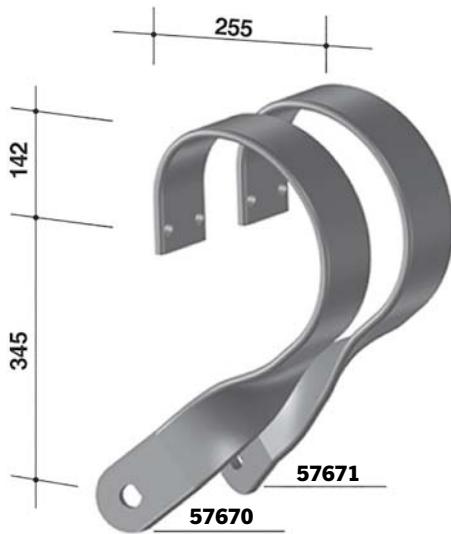

MOLLA 90x13

ARTICOLO	DESCRIZIONE
57670	Molla per dischi DX 90x13
57671	Molla per dischi SX 90x13
55906	Mozzo per dischi 4 fori
55904	Disco dentato Ø 460x4 mm - 4 fori
55905	Disco dentato Ø 510x4 mm - 4 fori

MOLLA 100x16

ARTICOLO	DESCRIZIONE
57668	Molla per dischi DX 100x16
57669	Molla per dischi SX 100x16
55906	Mozzo per dischi 4 fori
55905	Disco dentato Ø 510x4 mm - 4 fori
57672	Disco dentato Ø 560x5 mm - 4 fori

Zappe - Coltelli - Denti - Lame - Molle

BLADES - SPARE TINES FOR ROTARY HARROWS - CULTIVATOR SPRINGS

03

03

MODULO PER ORDINAZIONE DISCHI SPECIALI

FORMULAIRE COMMANDE DISQUES SPECIAUX - FORM FOR ORDERING SPECIAL DISCS - BESTELFORMULAR FÜR SPEZIALSCHEIBEN - MÓDULO PARA PEDIDO DISCOS ESPECIALES

FORATURA DISCHI BOMBATI

PERÇAGE DISQUES BOMBES
CONVEX DISC HOLES
LOCHUNG GEWÖLBTE SCHEIBEN
PERFORACIÓN DISCO BOMBEADOS

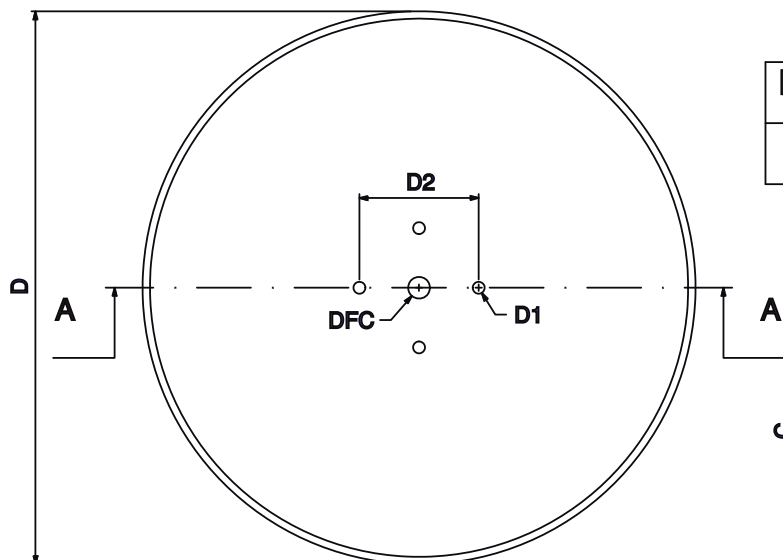

D	DFC	D1	D2	C	S	SV1°	SV2°	H

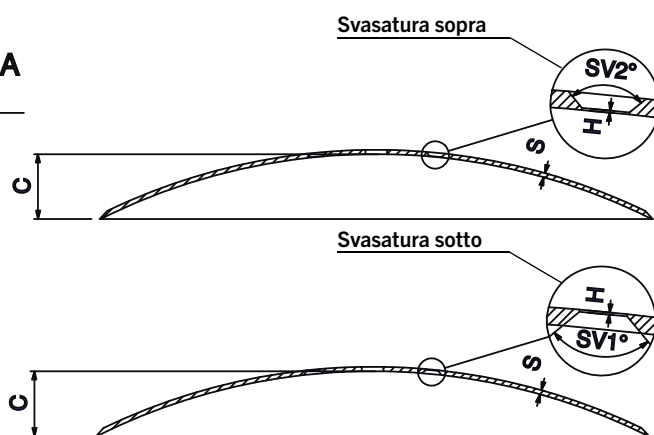

FORATURA DISCHI PIANI

PERÇAGE DISQUES PLATS
FLAT DISC HOLES
LOCHUNG FLACHSCHEIBEN
PERFORACIÓN DISCO PLANOS

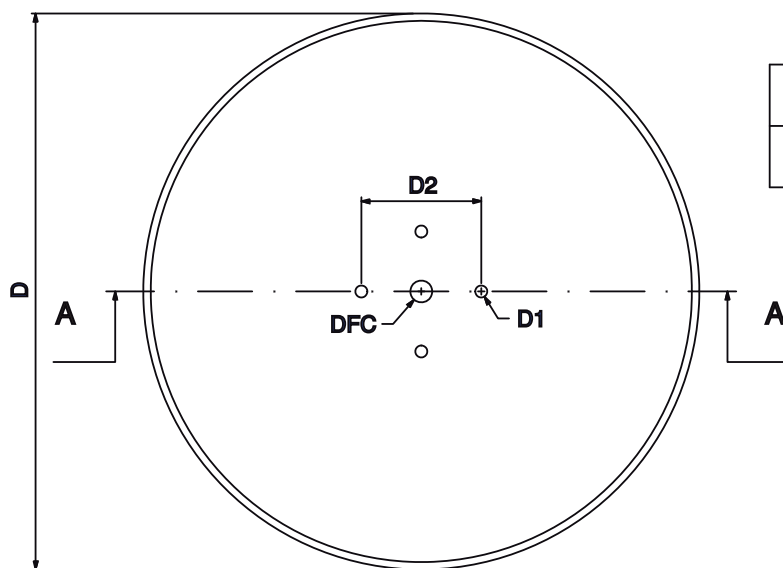

D	DFC	D1	D2	S	SV1°	SV2°	H

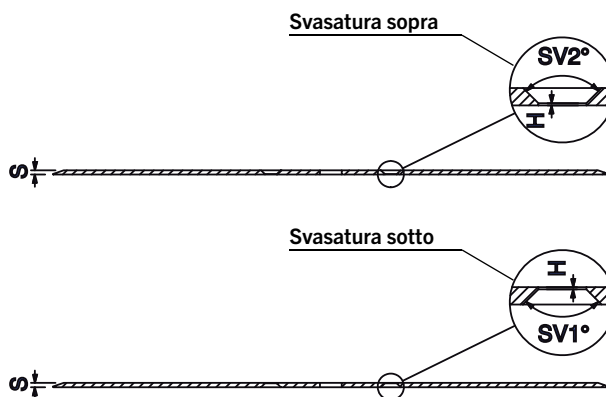

AVANVOMERI PER DISCHI BOMBATI (senza disco)

RASETTE POUR DISQUES ARRONDIS (sans disque)
 COULTERS FOR BOMBED DISCS (without disc)
 VORSCHÄLER FÜR GEWÖLBTE SCHEIBEN (ohne Scheibe)
 REJAS PARA DISCOS ABOMBADOS (sin disco)

new



CARATTERISTICHE

- Boccola supporto cuscinetti Ø 90 mm con perno saldato.
- Perno supporto centrale Ø 30 mm con ripresa centraggio disco.
- Interasse di fissaggio per disco Ø 116 mm con 4 fori Ø 13 mm.
- Provvisto di 2 cuscinetti a sfere a due corone obliqui.

ARTICOLO	DESCRIZIONE
57612	Avanvomere 50x30 con 4 fori interasse 116 mm
57613	Avanvomere 60x30 con 4 fori interasse 116 mm

DISCHI BOMBATI PER AVANVOMERE

DISQUES ARRONDIS POUR RASETTE
 CONVEX DISCS FOR COULTERS
 GEWÖLBTE SCHEIBEN FÜR VORSCHÄLER
 DISCOS ABOMBADOS PARA REJAS

new

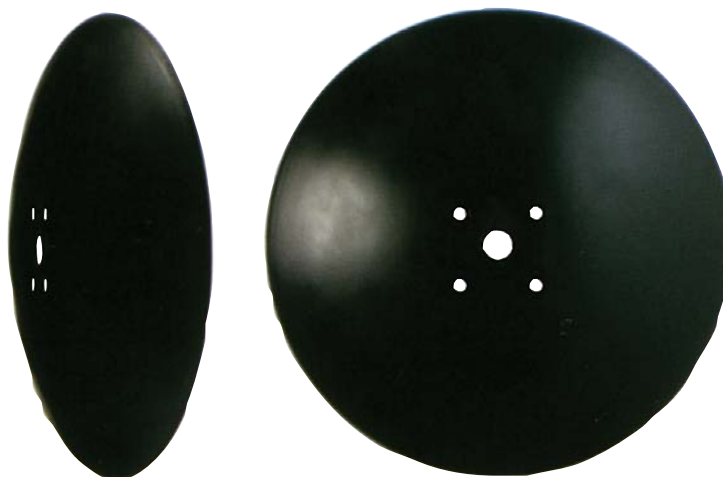

ARTICOLO	DIAMETRO mm	SPESSORE mm	CONCAVITÀ mm	Ø FORO CENTRALE mm	NR. FORI Ø13 mm	INTERASSE FORI mm
57614	310	4,5	23	26	4	116
57615	360	4,5	31	26	4	116
57616	410	6,0	39	26	4	116

Zappe - Coltelli - Denti - Lame - Molle

BLADES - SPARE TINES FOR ROTARY HARROWS - CULTIVATOR SPRINGS

03

03

ACCESSORI DISCHI FRANGIZOLLE

ACCESSOIRES POUR BRISE-MOTTES - ACCESSORIES FOR CLOD CRUSHERS - ZUBEHÖRTEILE FÜR SCHEIBENEGGEN - ACCESORIOS PARA ESCARIFICADORES

Supporto integrato

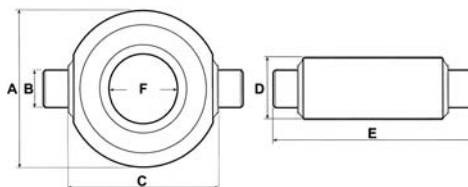

ACCESSORI PER ARTICOLO 57245

	
Cuscinetto nudo per 57245	Anello di tenuta per 57245
57618	57619

ARTICOLO	A mm	B mm	C mm	D mm	E mm	F mm
57244	97	26	114	48,5	147	45
57245	135	32	132	53	173,5	60
57566	146	40	146	56	192	70

Supporto fusion P70

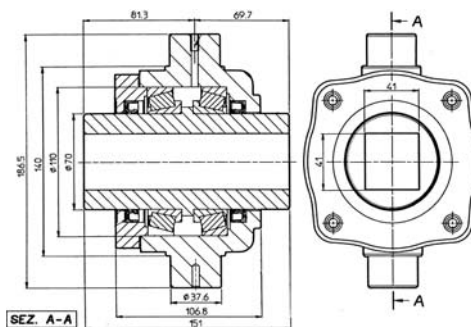

ARTICOLO
57246

Flangia concava di inizio sezione

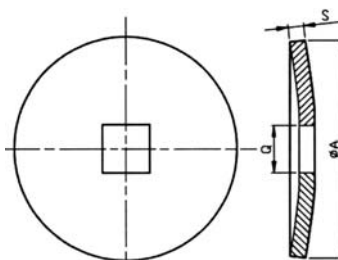

ARTICOLO	A mm	S mm	Q mm
57247	135	10	26
57249	145	12	31
57251	145	15	41
57254	155	15	41

Flangia convessa di fine sezione

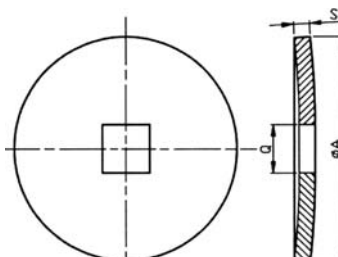

ARTICOLO	A mm	S mm	Q mm
57248	115	10	26
57250	135	12	31
57253	145	12	31
57252	145	15	41

segue ACCESSORI DISCHI FRANGIZOLLE

ACCESSOIRES POUR BRISE-MOTTES - ACCESSORIES FOR CLOD CRUSHERS - ZUBEHÖRTEILE FÜR SCHEIBENEGGEN - ACCESORIOS PARA ESCARIFICADORES

Semidistanziale

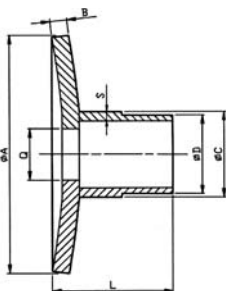

ARTICOLO	A mm	B mm	C mm	D mm	L mm	Q mm	S mm
57228	135	10	54	45	80	26	8
57237	145	12	63	55	82	31	8

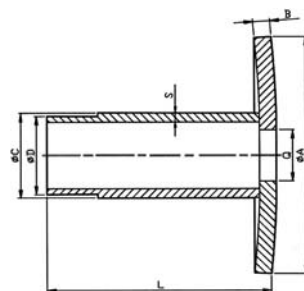

ARTICOLO	A mm	B mm	C mm	D mm	L mm	Q mm	S mm
57229	115	10	54	45	136	26	8
57238	145	12	63	55	139	31	8

Semidistanziale a cannocchiale

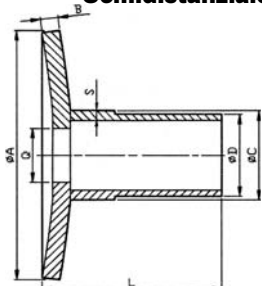

ARTICOLO	A mm	B mm	C mm	D mm	L mm	Q mm	S mm
57230	135	10	54	45	196	26	8
57242	135	12	70	60	193	31	10
57239	135	12	63,5	55	197	31	-

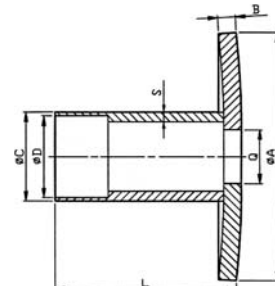

ARTICOLO	A mm	B mm	C mm	D mm	L mm	Q mm	S mm
57231	115	10	57	45	98	26	8
57243	135	12	70	60	94	31	8
57240	135	12	63,5	55	101	31	8,5

Supporto in lamiera con cuscinetto

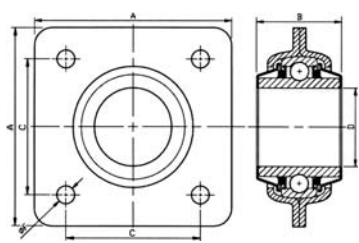

ARTICOLO	A mm	B mm	C mm	D mm	F mm
57232	121	46,5	85	45	13,5
57241	135	58,5	98	55	13,5

Distanziale

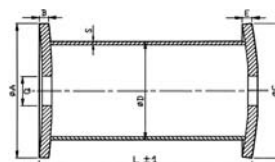

ARTICOLO	A mm	B mm	C mm	D mm	E mm	L mm	Q mm	S mm
57255	125	8	125	102	8	225,5	31	4
57226	125	6	125	89	6	221	26	3
57227	125	8	125	102	8	225,5	26	4
57236	145	10	145	114	10	225,5	31	4
57299	145	10	145	114	10	225,5	41	5

Raschietto fresato

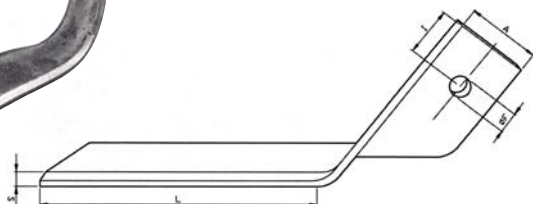

Il disegno rappresenta la versione SX

ARTICOLO	LATO	A mm	F mm	I mm	L mm	S mm
57233	DX	50	14,5	34	200	10
57234	SX	50	14,5	34	200	10

Squadretta fermaraschietto

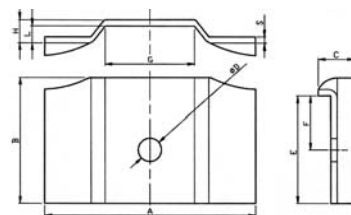

ARTICOLO	A mm	B mm	C mm	D mm	E mm	F mm	G mm	H mm	L mm	S mm
57235	118	70	20	13	60	30	50	13	9	3,5

Zappe - Coltelli - Denti - Lame - Molle

BLADES - SPARE TINES FOR ROTARY HARROWS - CULTIVATOR SPRINGS



03

MOLLE «FLEX-PALL» PER VIBROCOLTIVATORI

RESSORTS POUR COLTIVATEURS
SPRING TINES «FLEX-PALL» FOR CULTIVATORS
KULTIZINKE «FLEX-PALL» FÜR VIBRATIONSEGGE
MUELLES TIPO «FLEX-PALL» PARA VIBROCOLTIVADORES



ARTICOLO	DESCRIZIONE	DIMENSIONI	PESO kg
56785	Molla senza vomere	32x10 mm	1,67

VOMERE DIRITTO PER MOLLA 56785

SOC POUR VIBROCOLTEUR DANOIS
VIBROTILLER SHARE
SCHAR FÜR BLATTEFEDERZINKE
REJAS ABATIBLES



ARTICOLO	DESCRIZIONE	DIMENSIONI	PESO kg
56786	Vomere diritto	40x5 mm	1,80
55361	Bullone fissaggio	10x38 mm	0,03

MOLLE «FLEX-PALL» PER VIBROCOLTIVATORI

RESSORTS POUR COLTIVATEURS
SPRING TINES «FLEX-PALL» FOR CULTIVATORS
KULTIZINKE «FLEX-PALL» FÜR VIBRATIONSEGGE
MUELLES TIPO «FLEX-PALL» PARA VIBROCOLTIVADORES

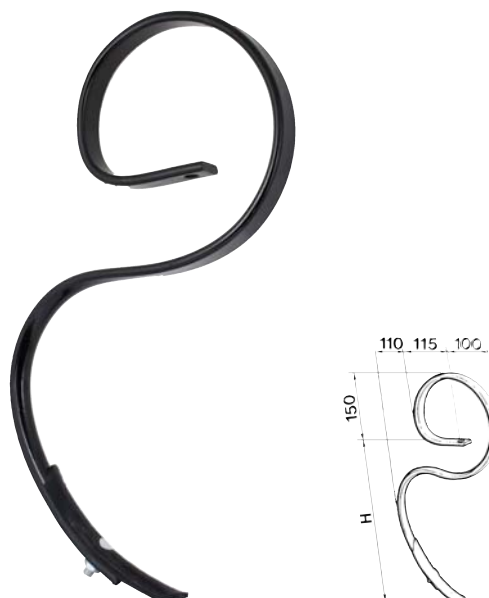

ARTICOLO	DESCRIZIONE	H mm	DIMENSIONI	PESO kg
55352	Molla senza vomere	390	32x10 mm	2,700
55353	Molla con vomere	390	32x10 mm	3,000
55354	Molla senza vomere	390	32x12 mm	3,200
55355	Molla con vomere	390	32x12 mm	3,500
56405	Molla con vomere	500	32x12 mm	3,650

MOLLE «FLEX-PALL» PER VIBROCOLTIVATORI

RESSORTS POUR COLTIVATEURS
SPRING TINES «FLEX-PALL» FOR CULTIVATORS
KULTIZINKE «FLEX-PALL» FÜR VIBRATIONSEGGE
MUELLES TIPO «FLEX-PALL» PARA VIBROCOLTIVADORES

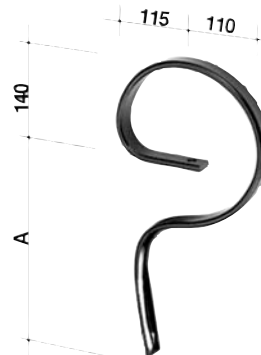

ARTICOLO	DESCRIZIONE	DIMENSIONI	A mm	PESO kg
57166	Molla senza vomere	32x10 mm	314	2,12
57167	Molla senza vomere	32x12 mm	314	2,54
57168	Molla senza vomere	32x12 mm	380	2,72

VOMERE DIRITTO PER MOLLA 57166-57167-57168

SOC POUR VIBROCOLTEUR DANOIS
VIBROTILLER SHARE
SCHAR FÜR BLATTEFEDERZINKE
REJAS ABATIBLES



ARTICOLO	DESCRIZIONE	DIMENSIONI	PESO kg
57169	Vomere diritto	40x6 mm	0,36
55361	Bullone fissaggio	10x38 mm	0,03

RINFORZI FLEX

CONTRE-RESSORT - AUXILIARY SPRING
VERSTAERKUNG FÜR KULTIZINKE FLEX - REFUERZO PARA MUELLES «FLEX»



RINFORZO FORATO

ARTICOLO	DIMENSIONI	PESO KG.
55356	32x10	1,450



RINFORZO AD OCCHIO

ARTICOLO	DIMENSIONI	PESO KG.
56382	32x10	1,500

VOMERINO REVERSIBILE IN ACCIAIO 55 Si 8

SOC POUR VIBROCOLTEUR DANOIS
VIBROTILLER SHARE
SCHAR FÜR BLATTEFEDERZINKE
REJAS ABATIBLES



ARTICOLO	DIMENSIONI	H mm	PESO kg
55358	40x5 mm	192	0,270
56565	40x6 mm	192	-
56566	40x8 mm	205	-
55361	Bullone fissaggio 10x38 mm		

MOLLE PER VIBROCOLTIVATORI TIPO RAU

RESSORTS POUR VIBROCOLTIVEURS
CULTIVATORS TINES
KULTIZINKE FÜR VIBRATIONSEGGE
MUELLES PARA VIBROCOLTIVADORES

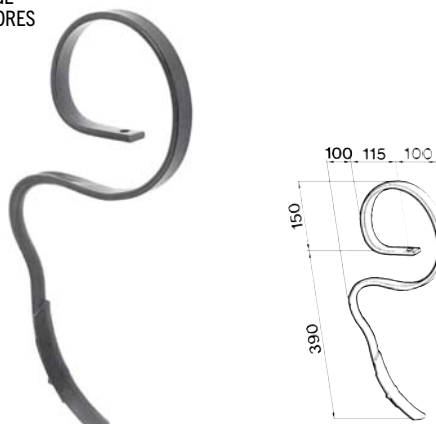

ARTICOLO	DESCRIZIONE	DIMENSIONI	PESO kg
55467	Molla senza vomere	32x10 mm	2,700
55468	Molla con vomere	32x10 mm	3,000

VOMERINO REVERSIBILE IN ACCIAIO 55 Si 8

SOC POUR VIBROCOLTIVEUR DANOIS
VIBROTILLER SHARE
SCHAR FÜR BLATTEFEDERZINKE
REJAS ABATIBLES



ARTICOLO	DIMENSIONI	PESO KG.
55470	40x5 mm	0,270
55361	Bullone fissaggio 10x38	

VOMERE PER VIBROCOLTIVATORI

SOCs POUR DENTS CULTIVATEUR
SHARE FOR COLTIVATOR
SCHAR FÜR VIBRATIONSEGGE
REJAS PARA VIBROCOLTIVADORES



ARTICOLO	DESCRIZIONE	DIMENSIONI	PESO kg	FIG.
55719	Vomere a lancia	105x4 mm	0,220	1
55359	Vomere a lancia	150x4 mm	0,400	2
55360	Vomere a lancia	175x4 mm	0,490	2
55720	Vomere a lancia	200x4 mm	0,500	2
56778	Vomere a lancia	250x4 mm	0,630	2
56157	Vomere a zampa d'oca	145x70 mm	0,220	3
55361	Bullone fissaggio vomeri	10x38 mm	0,030	4

RINFORZO FLEX AD OCCHIO

CONTRE-RESSORT
AUXILIARY SPRING
VERSTAERKUNG «FLEX»
REFUERZO «FLEX»



ARTICOLO	DIMENSIONI	PESO kg
55469	32x10	1,450

STAFFE PER MOLLE DA VIBROCOLTIVATORI

ETRIER POUR DENT VIBROCOLTIVEUR
VIBROTILLER TINE FRAME
HALTERUNGEN FÜR EINFACHEZINKE
ESTRIBOS PARA MUELLES



ARTICOLO	DESCRIZIONE	DIMENSIONI	MOLLE mm	RINFORZO	TELAIO mm	PESO kg
57151	Staffa monolama	50x8	32x10	-	50x12	0,295
57152	Staffa monolama	50x8	32x10	-	50x15	0,295
57153	Staffa monolama	50x8	32x12	-	50x15	0,295
57154	Staffa monolama	50x8	32x10	-	50x50	0,405
57155	Staffa monolama	50x8	32x12	-	50x50	0,405
57156	Staffa bilama (con rinforzo)	50x8	32x10	32x10	50x12	0,310
57157	Staffa bilama (con rinforzo)	50x8	32x10	32x10	50x15	0,310
57158	Staffa bilama (con rinforzo)	50x8	32x12	32x10	50x15	0,310
57159	Staffa bilama (con rinforzo)	50x8	32x10	32x10	50x50	0,420
57160	Staffa bilama (con rinforzo)	50x8	32x12	32x10	50x50	0,420
57320	Bullone 12x50 mm					
57321	Bullone 12x60 mm					
57322	Bullone 12x80 mm					
57323	Bullone 12x90 mm					

STAFFE PER MOLLE DA VIBROCOLTIVATORI

ETRIER POUR DENT VIBROCOLTIVEUR
VIBROTILLER TINE FRAME
HALTERUNGEN FÜR EINFACHEZINKE
ESTRIBOS PARA MUELLES



ARTICOLO	DESCRIZIONE	DIMENSIONI	MOLLE mm	RINFORZO	TELAIO mm	PESO kg
55378	Staffa monolama	50x6	32x10	-	50x12	0,245
55379	Staffa monolama	50x6	32x10	-	50x15	0,250
55380	Staffa monolama	50x6	32x12	-	50x15	0,255
57147	Staffa monolama	50x6	32x10	-	50x50	0,335
57148	Staffa monolama	50x6	32x12	-	50x50	0,340
55381	Staffa bilama (con rinforzo)	50x6	32x10	32x10	50x12	0,250
55357	Staffa bilama (con rinforzo)	50x6	32x10	32x10	50x15	0,255
55466	Staffa bilama (con rinforzo)	50x6	32x12	32x10	50x15	0,260
57149	Staffa bilama (con rinforzo)	50x6	32x10	32x10	50x50	0,340
57150	Staffa bilama (con rinforzo)	50x6	32x12	32x10	50x50	0,345
57320	Bullone 12x50 mm					
57321	Bullone 12x60 mm					
57322	Bullone 12x80 mm					
57323	Bullone 12x90 mm					

Zappe - Coltelli - Denti - Lame - Molle

BLADES - SPARE TINES FOR ROTARY HARROWS - CULTIVATOR SPRINGS



03

MOLLE PER VIBROCOLTIVATORI 45x12

DENTS POUR VIBROCOLTEURS
CULTIVATORS TINES
KULTIZINKE FÜR VIBRATIONSEGGE
MUELLES PARA VIBROCOLTIVADORE

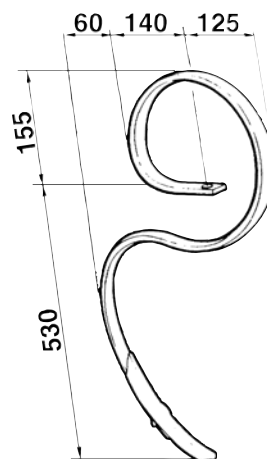

ARTICOLO	DESCRIZIONE	DIMENSIONI mm	INTERASSE FORI mm	PESO kg
56381	Molla senza vomere	45x12	-	5,00
56408	Molla con vomere	45x12	-	5,75
57161	Molla 2 FORI senza vomere	45x12	45	5,00

RINFORZO FLEX AD OCCHIO

CONTRE-RESSORT
AUXILIARY SPRING
VERSTAERKUNG «FLEX» TYP EGGE
REFUERZO «FLEX»

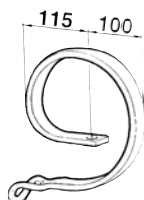

ARTICOLO	DIMENSIONI mm	PESO kg
56383	45x10	2,600

VOMERE A LANCIA IN ACCIAIO 55 Si 8 PER MOLLA 57161

SOC POUR VIBROCOLTEUR DANOIS
VIBROTILLER SHARE
SCHAR FÜR BLATTEFEDERZINKE
REJAS ABATIBLES



FIG.2



FIG.3

ARTICOLO	DIMENSIONI mm	FIGURA
57282	60x6	1
57162	150x6	2
57163	175x6	2
57164	200x6	2
57165	250x6	2
56409	Bullone di fissaggio 10x45	3

FIG.1

VOMERINO REVERSIBILE IN ACCIAIO 55 Si 8 PER MOLLE 56381 - 56408

SOC POUR VIBROCOLTEUR DANOIS
VIBROTILLER SHARE
SCHAR FÜR BLATTEFEDERZINKE
REJAS ABATIBLES



ARTICOLO	DIMENSIONI mm	PESO kg
56399	60x6	0,710
56409	Bullone fissaggio 10x45	

STAFFE PER MOLLE DA VIBROCOLTIVATORI

ETRIER POUR DENT VIBROCOLTEUR
VIBROTILLER TINE FRAME
HALTERUNGEN FÜR EINFACHEZINKE
ESTRIBOS PARA MUELLES



ARTICOLO	DESCRIZIONE	DIMENSIONI mm	MOLLE mm	RINFORZO	TELAIO mm	PESO kg
56902	Staffa monolama	70x8	45x12	-	50x50	0,60
56903	Staffa monolama	70x8	45x12	-	60x60	0,68
56384	Staffa bilama (con rinforzo)	70x8	45x12	45x10	50x50	0,63
56394	Staffa bilama (con rinforzo)	70x8	45x12	45x10	60x60	0,72
57323	Bullone 12x90 mm					
56562	Bullone 12x100 mm					
56563	Bullone 12x110 mm					

MOLLE PER VIBROCOLTIVATORI 60x12 A 2 FORI

DENTS POUR VIBROCOLTEURS
CULTIVATORS TINES
KULTIZINKE FÜR VIBRATIONSEGGE
MUELLES PARA VIBROCOLTIVADORES

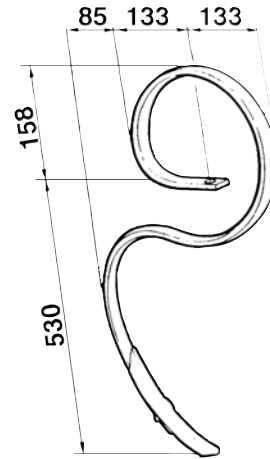

ARTICOLO	DESCRIZIONE	DIMENSIONI mm	INTERASSE FORI mm	PESO kg
56555	Molla senza vomere	60x12	28	7
56556	Molla con vomere	60x12	28	7,75

RINFORZO FLEX AD OCCHIO

CONTRE-RESSORT
AUXILIARY SPRING
VERSTAERKUNG «FLEX» TYP EGGE
REFUERZO «FLEX»



ARTICOLO	DIMENSIONI	PESO kg
56557	60x10 mm	3,38

VOMERINO REVERSIBILE IN ACCIAIO 55 Si 8

SOC POUR VIBROCOLTEUR DANOIS
VIBROTILLER SHARE
SCHAR FÜR BLATTEFEDERZINKE
REJAS ABATIBLES



ARTICOLO	DESCRIZIONE	DIMENSIONI
57283	Reversibile	60x6 mm
56558	A lancia	200x6 mm
56559	Bullone fissaggio 10x55	

STAFFE PER MOLLE DA VIBROCOLTIVATORI

ETRIER POUR DENT VIBROCOLTEUR
VIBROTILLER TINE FRAME
HALTERUNGEN FÜR EINFACHEZINKE
ESTRIBOS PARA MUELLES



ARTICOLO	DESCRIZIONE	TELAIO mm	DIMENSIONI mm
56560	Staffa monolama	60x60	90x8
56561	Staffa bilama	60x60	90x8
56562	BULLONE 12x100 mm		
56563	BULLONE 12x110 mm		

Zappe - Coltelli - Denti - Lame - Molle

BLADES - SPARE TINES FOR ROTARY HARROWS - CULTIVATOR SPRINGS



03 MOLLE PER VIBROCOLTIVATORE ELEPHANT 70x12 SENZA VOMERE

DENTS POUR VIBROCOLTEUR ELEPHANT
ELEPHANT CULTIVATORS TINES
KULTIZINKE FÜR VIBRATIONSEGGE ELEPHANT
MUELLES PARA VIBROCOLTIVADORE ELEPHANT

new



ARTICOLO	DESCRIZIONE	DIMENSIONI mm	INTERASSE FORI mm	PESO kg
57655	Molla senza vomere	70x12	45	9,42

RINFORZO MOLLA

CONTRE-RESSORT
AUXILIARY SPRING
FEDERVERSTÄRKUNG
REFUERZO

new



ARTICOLO	DIMENSIONI	PESO kg
57656	70x10	5,70

VOMERINO REVERSIBILE E A LANCIA

SOC POUR VIBROCOLTEUR DANOIS
VIBROTILLER SHARE
SCHAR FÜR BLATTEFEDERZINKE
REJAS ABATIBLES

new



ARTICOLO	DESCRIZIONE	DIMENSIONI
57657	Vomere reversibile	460x10x300
57658	Vomere a lancia	150x8
57659	Vomere a lancia	200x8
57660	Vomere a lancia	250x8
57661	Vomere a lancia	300x8
57662	Vomere a lancia	350x8

STAFFE PER MOLLE DA VIBROCOLTIVATORI

ETRIER POUR DENT VIBROCOLTEUR
VIBROTILLER TINE FRAME
HALTERUNGEN FÜR EINFACHEZINKE
ESTRIBOS PARA MUELLES

new



ARTICOLO	DESCRIZIONE	TELAIO mm	DIMENSIONI mm
57663	Staffa monolama	80x80	100x10
57664	Staffa bilama	80x80	100x10

MOLLE PER VIBROCOLTIVATORE MAMMUTH 80x12 SENZA VOMERE

DENTS POUR VIBROCOLTEUR MAMMUTH
MAMMUTH CULTIVATORS TINES
KULTIZINKE FÜR VIBRATIONSEGGE MAMMUTH
MUELLES PARA VIBROCOLTIVADORE MAMMUTH

new



ARTICOLO	DESCRIZIONE	DIMENSIONI mm	INTERASSE FORI mm	PESO kg
57673	Molla senza vomere	80x12	45	11,13

RINFORZO MOLLA

CONTRE-RESSORT
AUXILIARY SPRING
FEDERVERSTÄRKUNG
REFUERZO

new



ARTICOLO	DIMENSIONI	PESO kg
57665	80x10	5,86

VOMERINO REVERSIBILE E A LANCIA

SOC POUR VIBROCOLTEUR DANOIS
VIBROTILLER SHARE
SCHAR FÜR BLATTEFEDERZINKE
REJAS ABATIBLES

new



ARTICOLO	DESCRIZIONE	DIMENSIONI
57657	Vomere reversibile	460x10x300
57658	Vomere a lancia	150x8
57659	Vomere a lancia	200x8
57660	Vomere a lancia	250x8
57661	Vomere a lancia	300x8
57662	Vomere a lancia	350x8

STAFFE PER MOLLE DA VIBROCOLTIVATORI

ETRIER POUR DENT VIBROCOLTEUR
VIBROTILLER TINE FRAME
HALTERUNGEN FÜR EINFACHEZINKE
ESTRIBOS PARA MUELLES

new



ARTICOLO	DESCRIZIONE	TELAIO mm	DIMENSIONI mm
57666	Staffa monolama	80x80	110x10
57667	Staffa bilama	80x80	110x10

Zappe - Coltelli - Denti - Lame - Molle

BLADES - SPARE TINES FOR ROTARY HARROWS - CULTIVATOR SPRINGS



03

MOLLA PER ERPICE 25x8 mm

RESSORT POUR VIBROCULTEURS
VIBROTILLER SPRING TINE
KULTIZINKE FÜR VIBRATIONSEGGE
MUELLES PARA VIBROCULTIVADORES

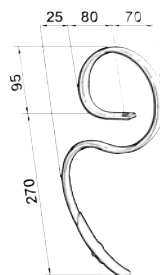

ARTICOLO	DESCRIZIONE
56567	Molla senza vomere 25x8 mm
56568	Molla con vomere 25x8 mm

MOLLA PER ERPICE SENZA FORO VOMERE

RESSORT POUR VIBROCULTEURS
VIBROTILLER SPRING TINE
KULTIZINKE FÜR VIBRATIONSEGGE
MUELLES PARA VIBROCULTIVADORES

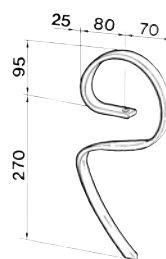

ARTICOLO	DIMENSIONI mm	PESO kg
55474	25x8	1,060

MOLLA PER ERPICE - ROVESCIA

RESSORT POUR VIBROCULTEURS
VIBROTILLER SPRING
KULTIZINKE FÜR VIBRATIONSEGGE
MUELLES PARA VIBROCULTIVADORES

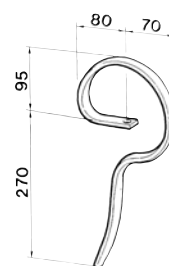

ARTICOLO	DIMENSIONI mm	PESO kg
55475	25x8	0,950

VOMERE E BULLONE PER MOLLE DA ERPICE 56567 - 56568

SOC ET VIS POUR RESSORT POUR VIBROCULTEURS 56567 - 56568
SHARE AND SCREW FOR VIBROTILLER SPRINGS 56567 - 56568
SCHAR UND SCHRAUB FÜR KULTIZINKE 56567 - 56568
REJA Y TORNILLO PARA MUELLES PARA VIBROCULTIVADORES 56567 - 56568

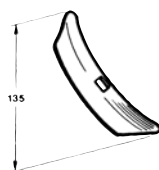

ARTICOLO	DIMENSIONI mm	LUNGHEZZA mm
55978	40x5	135
56569	Bullone fissaggio vomere 10x30 mm per Cod. 56567-56568	

STAFFA PER MOLLE 55474 - 55475 - 56567 - 56568

ETRIER POUR DENT VIBROCULTEUR
VIBROTILLER TINE FRAME
HALTERUNG FÜR ZINKEN
ESTRIBO PARA MUELLES



ARTICOLO	DIMENSIONI mm	TELAIO mm
55520	40x6	40x10
56570	BULLONE PER STAFFA	

MOLLA PER ROMPITRACCIA CON VOMERE 40x10 mm

EFFACEUR DE TRACE AVEC RENFORT
TRACE REMOVER WITH STIFFENING
ZINKEN MIT SCHAR
MUELLES ELIMINADORES DE HUELLAS CON REJA

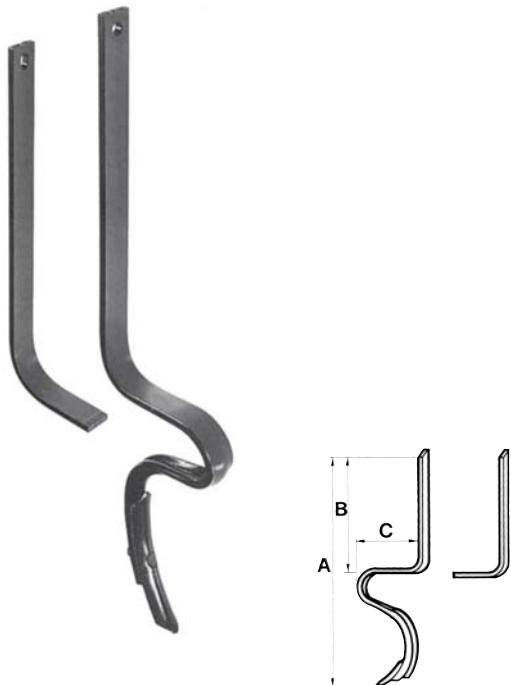

ARTICOLO	TIPO	SEZIONE	A mm	B mm	C mm
56604	Molla con vomere senza rinforzo	40x10 mm	770	445	165
56605	Rinforzo	mm	-	-	-

MOLLA PER ROMPITRACCIA CON VOMERE 32x10 mm

EFFACEUR DE TRACE AVEC RENFORT
TRACE REMOVER WITH STIFFENING
ZINKEN MIT SCHAR
MUELLES ELIMINADORES DE HUELLAS CON REJA

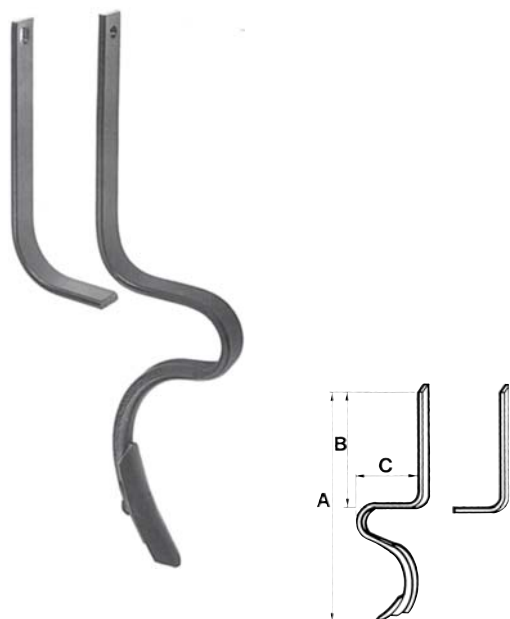

ARTICOLO	TIPO	SEZIONE	A mm	B mm	C mm
55476	Molla con vomere e senza rinforzo	32x10 mm	570	270	175
55977	Rinforzo	mm	—	—	—

VOMERE E BULLONE PER MOLLA ROMPITRACCIA 40x10 mm

SOC ET VIS
SHARE AND SCREW
SCHAR UND SCHRAUB
REJA Y TORNILLO



ARTICOLO	DIMENSIONI mm	H mm	PESO kg
55358	40x5	192	0,270
55361	Bullone fissaggio 10x38 mm		

VOMERE E BULLONE PER MOLLE ROMPITRACCIA ART. 55476

SOC ET VIS POUR RESSORT POUR EFFACEUR DE TRACE ART. 55476
SHARE AND SCREW FOR TRACE REMOVER ART. 55476
SCHAR UND SCHRAUB FÜR ZINKEN ART. 55476
REJA Y TORNILLO PARA MUELLES ELIMINADORES DE HUELLAS ART. 55476

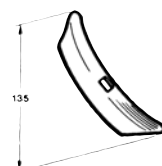

ARTICOLO	DIMENSIONI mm	LUNGHEZZA mm
55978	40x5	135
55361	Bullone fissaggio vomere 10x38 mm per Cod. 55476	

MOLLE TITAN CON VOMERE

DENTS TITAN
TITAN SPRINGS TINES
ZINKEN TYP TITAN
MUELLES TIPO TITAN

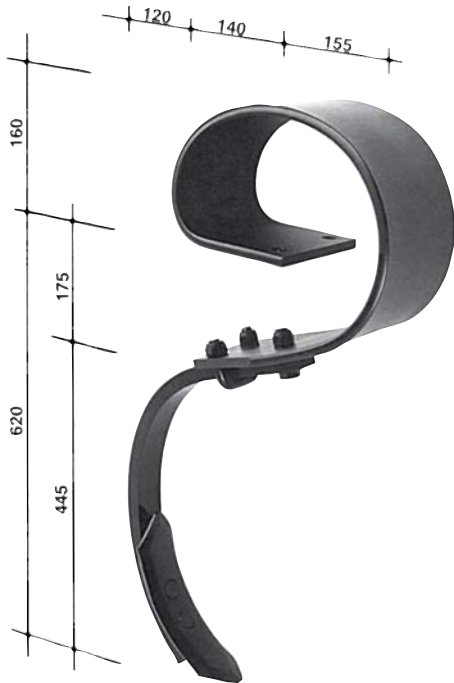

ARTICOLO
57291



ARTICOLO
57293



DIMENSIONI

- LUNGHEZZA: 250 mm
- LARGHEZZA: 65 mm
- SPESSORE: 8 mm
- INTERASSE FORI: 45 mm



ARTICOLO	DESCRIZIONE
57292	Vomere reversibile
55382	Bullone vomere



ARTICOLO	DESCRIZIONE
57294	Staffa completa



Zappe - Coltelli - Denti - Lame - Molle

BLADES - SPARE TINES FOR ROTARY HARROWS - CULTIVATOR SPRINGS



03

MOLLE TIPO QUADRO PER ESTIRPATORI

DENTS CARRÉS POUR CULTIVATEURS
CULTIVATOR TEETH (square section)
VIERKANTIGE ZINKEN FÜR SCHAREGGE
MUELLES TIPO CUADRO PARA EXTIRPADORES



Il disegno rappresenta una molla sinistra

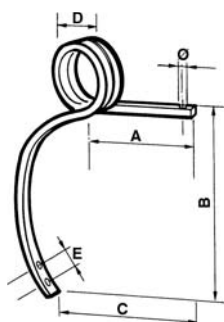

MOLLE STANDARD

ARTICOLO	LATO	QUADRO mm	A mm	B mm	C mm	D mm	E mm	Ø FORO mm
55477	DX	25x25	240	455	365	120	45	13
55478	SX	25x25	240	455	365	120	45	13
55479	DX	30x30	280	535	365	120	45	17
55509	SX	30x30	280	535	365	120	45	17
57597	DX	35x35	260	635	400	145	75	17
57596	SX	35x35	260	635	400	145	75	17

MOLLE ALTE

ARTICOLO	LATO	QUADRO mm	A mm	B mm	C mm	D mm	E mm	Ø FORO mm
56606	DX	25x25	240	520	310	120	45	13
56607	SX	25x25	240	520	310	120	45	13
56608	DX	30x30	280	635	310	120	45	17
56609	SX	30x30	280	635	310	120	45	17

VOMERE A LANCIA PER MOLLE TIPO QUADRO

SOCS POUR DENTS CARRÉS
SHARES FOR SQUARE SPRINGS
SCHAREN FÜR VIERKANTIGE ZINKEN
REJAS PARA MUELLES TIPO CUADRO



ARTICOLO	DIMENSIONI mm	Ø FORI mm	INTERASSE FORI mm
55986	210x6	12	45 - 50
55990	Bullone 12x55 per molle 25x25 mm		
55835	Bullone 12x60 per molle 30x30 mm		

VOMERE REVERSIBILE PER MOLLE TIPO QUADRO

SOCS POUR DENT CARRÉ
SHARES FOR SQUARE TYPE SPRINGS
SCHAREN FÜR VIERKANTIGE ZINKEN
REJAS ABATIBLES PARA MUELLES TIPO CUADRO



ARTICOLO	DIMENSIONI mm	L mm	Ø FORI mm	INTERASSE FORI mm
55480	40x16	270	12	45
57209	60x12	285	12	45-65
55203	55x15	360	12	75
55990	Bullone 12x55 per molle 25x25 mm			
55835	Bullone 12x60 per molle 30x30 mm			

STAFFA COMPLETA PER MOLLE TIPO QUADRO

BRIDE COMPLÈTE POUR DENTS CARRÉS
COMPLETE TINE FRAME FOR SQUARE TYPE SPRINGS
VOLLKOMMEN HALTERUNG FÜR VIERKANTIGE ZINKEN
ESTRIBOS COMPLETO PARA MUELLES TIPO CUADRO



ARTICOLO	QUADRO MOLLA mm	TELAIO mm
55987	25x25	80x80
55988	30x30	80x80
55989	30x30	100x100

CAVALLOTTI PER STAFFE SENZA DADI

ARCEAUX POUR ETRIERS SANS ECROUS
U-BOLTS FOR STIRRUPS WITHOUT NUTS
STIFTSCHRAUBEN FÜR BÜGEL OHNE MUTTERN
HORQUILLAS PARA BRIDAS SIN TUERCAS

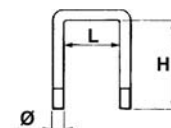

N.B.: i dadi non sono compresi nei codici dei cavallotti e sono quindi da ordinare separatamente.

ARTICOLO	DESCRIZIONE	TELAIO mm	L mm	H mm	Ø mm
57275	Cavallotto per staffa	80x80	81	123	16
57276	Cavallotto per staffa	100x100	100	150	18
57277	Cavallotto quadro per molla Chisel	100x100	100	180	18
57278	Dado M16x2				
57279	Dado M18x2,5				

STAFFE PER MOLLE TIPO QUADRO

BRIDES POUR DENT CARRÉ
CLAMPS FOR SQUARE TYPE SPRINGS
HALTERUNG FÜR VIERKANTIGE ZINKEN
ESTROBOS PARA MUELLES TIPO CUADRO

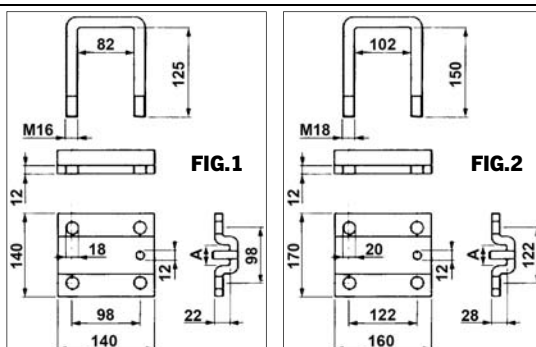

ARTICOLO	TELAIO mm	QUADRO DELLA MOLLA mm	A mm	FIG.
56572	80x80	25 mm	28	1
56573	80x80	30 mm	32	1
57290	100x100	30 mm	32	2
57599	100x100	35 mm	32	2

MOLLE CHISEL SENZA VOMERE

DENTS CHISEL SANS SOC
CHISEL SPRINGS WITHOUT SHARE
ZINKEN TYP CHISEL OHNE SCHAR
MUELLES TIPO CHISEL SIN REJAS

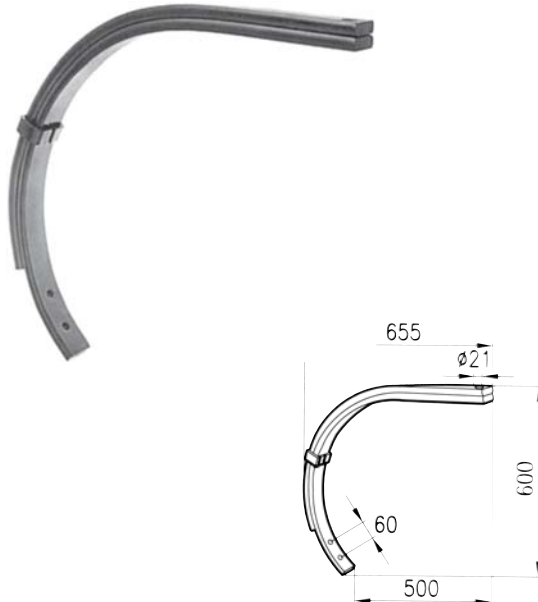

ARTICOLO	DIMENSIONI mm	CONTROMOLLA mm	PESO kg
55481	55x20	55x20	16,800

STAFFA PER MOLLE TIPO CHISEL

BRIDE POUR CHISEL
CLAMP FOR CHISEL SPRING
HALTERUNG FÜR ZINKEL TYP CHISEL
ESTRIBO PARA MUELLES TIPO CHISEL

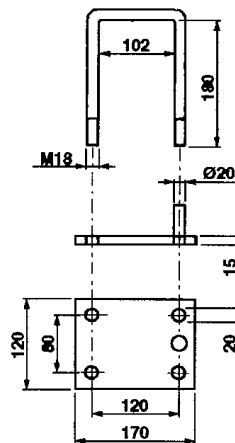

N.B.: i dadi **non** sono compresi nel codice della staffa e sono quindi da ordinare separatamente.

ARTICOLO	DESCRIZIONE	TELAIO mm
56591	Staffa per molle tipo Chisel	100x100
57279	Dado M18x2,5	

MOLLE CHISEL SENZA VOMERE

DENTS CHISEL SANS SOC
CHISEL SPRINGS WITHOUT SHARE
ZINKEN TYP CHISEL OHNE SCHAR
MUELLES TIPO CHISEL SIN REJAS

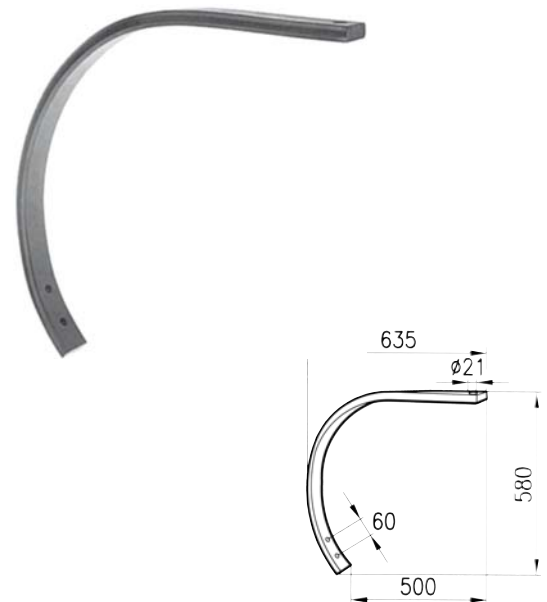

ARTICOLO	DIMENSIONI mm	PESO kg
55482	55x25	11,270

VOMERE REVERSIBILE PER MOLLE CHISEL

SOC POUR DENT CULTIVATEUR CHISEL
SHARE FOR CHISEL CULTIVATOR TINE
SCHAR FÜR BLATTFEDERZINKE CHISEL
REJAS ABATIBLES PARA MUELLES CHISEL



ARTICOLO	DESCRIZIONE	DIMENSIONI mm	Ø FORI mm	L mm	INTERASSE FORI mm	PESO kg
55483	Vomere reversibile	55x15	12	360	60	2,07
57142	Vomere reversibile	55x15	12	400	45-65 (con asola)	2,60
56271	Vomere a doppio cuore	130	12	440	60	-
55382	Bullone 12x50 per molla Chisel 55481					
55835	Bullone 12x60 per molla Chisel 55482					

Zappe - Coltelli - Denti - Lame - Molle

BLADES - SPARE TINES FOR ROTARY HARROWS - CULTIVATOR SPRINGS

03

03

MOLLE A BALESTRA PER COLTIVATORI COMPLETI DI RINFORZO E VOMERE

DENTS POUR CULTIVATEUR AVEC RENFORT ET SOC
SPRINGS FOR CULTIVATOR WITH REINFORCEMENT AND SHARE
BLATT FEDER FÜR EGGE MIT VERSTÄRKUNG UN SCHAR
MUELLES PARA CULTIVADOR CON RENFORZE Y REJA



VOMERE E BULLONI PER MOLLE A BALESTRA DA COLTIVATORI ART. 55979 - 55980 - 56000

SOC ET VIS POUR DENTS CULTIVATEUR ART. 55979 - 55980 - 56000
SHARE AND SCREWS FOR SPRINGS-CULTIVATOR ART. 55979 - 55980 - 56000
SCHAR UND SCHRAUBEN FÜR BLATT FEDER FÜR EGGE ART. 55979 - 55980 - 56000
REJA Y TURNILLOS PARA MUELLES - CULTIVADOR ART. 55979 - 55980 - 56000



ARTICOLO	DIMENSIONI mm	INTERASSE FORI mm
55981	45x7	45/50
55837	Bullone 10x30 mm	
55982	Bullone 10x40 mm	
55983	Bullone 10x45 mm	

STAFFE COMPLETE PER MOLLE

BRIDES COMPLETE POUR DENTS
COMPLETE CLAMPS FOR SPRINGS
VOLLKOMMEN HALTERUNGEN FÜR ZINKEN
ESTRIBOS COMPLETO PARA MUELLES



ARTICOLO	DESCRIZIONE
56001	Staffa per molla 56000 telaio 65x42
55984	Staffa per molla 55979 telaio 65x42
55985	Staffa per molla 55980 telaio 80x60

VOMERE A LANCIA PER MOLLE A BALESTRA CON FORO ED ASOLA

SOC POUR DENTS AVEC TROU
SHARE FOR SPRINGS WITH HOLE
SCHAR FÜR BLATTFEDER MIT LOCH UND LANGLOCH
REJA PARA MUELLES CON FORO Y OJAL

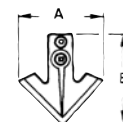
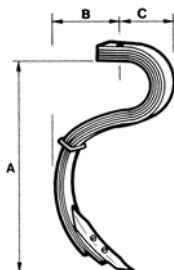

ARTICOLO	DESCRIZIONE	PIATTO mm	A mm	B mm	C mm
56000	Molla a 2 foglie con rinforzo e vomere	45x7	480	200	107
55979	Molla a 3 foglie con rinforzo e vomere	45x7	520	215	113
55980	Molla a 4 foglie con rinforzo e vomere	45x7	530	225	120

ARTICOLO	DIMENSIONI Ax B mm	Ø FORI mm	INTERASSE DA / A mm	PESO kg
55730	200x240	12	45/50	1,500

MOLLA SARCHIATRICE BV 32X12

RESSORT BINEUSE BV 32X12
WEEDER SPRING BV 32X12
FEDER FÜR EGGE BV 32X12
MUELLE BINADOR BV 32X12



new

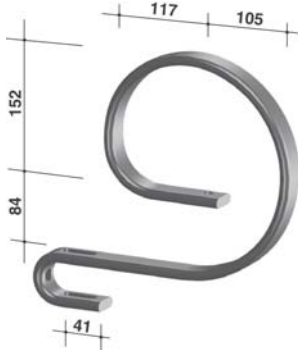

ARTICOLO	DIMENSIONI mm	PESO kg
57650	32x12	2,56

MOLLA SARCHIATRICE BUD 32X12

RESSORT BINEUSE BUD 32X12
WEEDER SPRING BUD 32X12
FEDER FÜR EGGE BUD 32X12
MUELLE BINADOR BUD 32X12



new

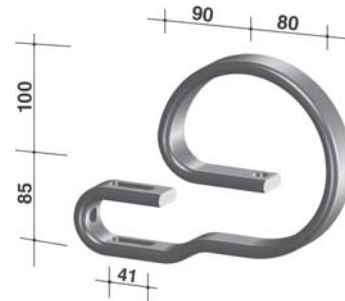

ARTICOLO	DIMENSIONI mm	PESO kg
57651	32x12	1,95

GAMBO VOMERE CENTRALE 32X10

TIGE SOC CENTRALE 32X10
CENTRAL PLOUGHSHANK 32X10
ZENTRALE PFLUGSCHAR 32X10
VÁSTAGO REJA CENTRAL 32X10



new



ARTICOLO	DESCRIZIONE	DIMENSIONI mm
57652	Gambo vomere centrale	32x10
57654	Dado di fissaggio gambo	-

GAMBO VOMERE LATERALE 32X10

TIGE SOC LATÉRALE 32X10
LATERAL PLOUGHSHANK 32X10
SEITLICHE PFLUGSCHAR 32X10
VÁSTAGO REJA LATERAL 32X10



new



ARTICOLO	DESCRIZIONE	DIMENSIONI mm
57653	Gambo vomere laterale	32x10
57654	Dado di fissaggio gambo	-

VOMERI LATERALI PER SARCHIATRICI

SOCs LATÉRALE POUR SARCLEURS
LATERAL SHARES FOR TRACTOR HOES
SEITLICHE SCHAREN FÜR HACKEN
REJAS LATERAL PARA BINADORAS



Versione SX

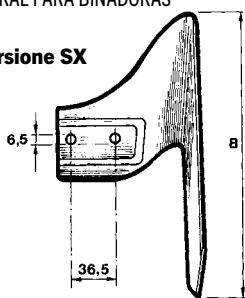

Versione DX

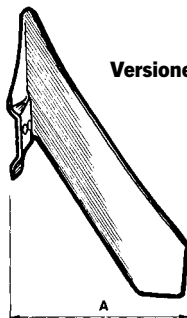

ARTICOLO	DIMENSIONI AxB mm	Ø FORO mm	INTERASSE mm	PESO kg
56145	120x220 Dx	6,5	36,5	0,480
56146	120x220 Sx	6,5	36,5	0,480
56147	140x250 Dx	6,5	36,5	0,530
56148	140x250 Sx	6,5	36,5	0,530
56149	160x270 Dx	6,5	36,5	0,550
56150	160x270 Sx	6,5	36,5	0,550
56151	180x300 Dx	6,5	36,5	0,600
56152	180x300 Sx	6,5	36,5	0,600
56153	200x320 Dx	6,5	36,5	0,650
56154	200x320 Sx	6,5	36,5	0,650

VOMERI PER SARCHIATRICI

SOCs POUR SARCLEURS
SHARES FOR TRACTOR HOES
SCHAREN FÜR HACKEN
REJAS PARA BINADORAS

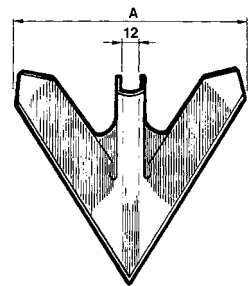
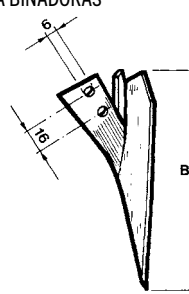

ARTICOLO	DIMENSIONI AxB mm	Ø FORO mm	INTERASSE mm	PESO kg
56135	120x120	6	16	0,270
56136	140x135	6	16	0,300
56137	160x145	6	16	0,340
56138	180x150	6	16	0,360
56139	200x165	6	16	0,440
56140	220x180	6	16	0,460
56141	240x190	6	16	0,530
56142	260x210	6	16	0,550
56143	280x220	6	16	0,600
56144	300x230	6	16	0,630

Zappe - Coltelli - Denti - Lame - Molle

BLADES - SPARE TINES FOR ROTARY HARROWS - CULTIVATOR SPRINGS

03

03

ANCORE RIPUNTATORE

DENTS SOUS-SOLEUSE
SUBSOILER TINES
ZINKEN FÜR TIEFENLOCKERER
ANCLAS SUBSOLADORES



FIG.2a



FIG.2



FIG.1



ATTENZIONE:
l'ancora è da comporre!

Le foto rappresentano la versione DX

ANCORA LUNGA 600

ARTICOLO	DESCIZIONE	FIG.
57210	Lama da 600 DX	1
57211	Lama da 600 SX	1
57212	Controlama DX	2
57213	Controlama SX	2
57214	Punta lama da 600 (interasse fori 85 mm)	3
57215	Kit bulloni da 600	-

ANCORA LUNGA 800

ARTICOLO	DESCIZIONE	FIG.
57216	Lama da 800 DX	1
57217	Lama da 800 SX	1
57218	Controlama corta DX	2
57219	Controlama corta SX	2
57385	Controlama lunga DX	2a
57386	Controlama lunga SX	2a
57220	Punta lama da 800 (interasse fori 80mm)	3
57221	Kit bulloni da 800	-

RICAMBI PER COLTIVATORI TIPO HORSCH

PIÈCES DE RECHANGE POUR CULTIVATEURS TYPE HORSCH
SPARE PARTS FOR HORSCH-TYPE CULTIVATORS
ERSATZTEILE FÜR GRUBBER TYP HORSCH
PIEZAS DE REPUESTO PARA CULTIVADORES TIPO HORSCH

new

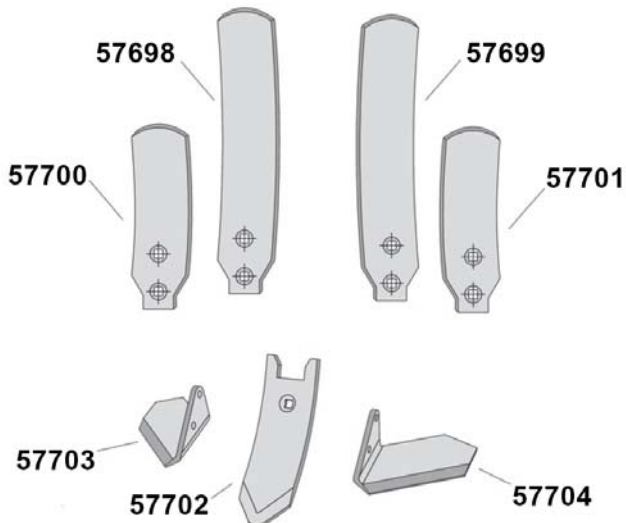

ARTICOLO	DESCIZIONE	DIMENSIONE	COD. HORSCH
57700	Lama posteriore L.270 DX	A: 270 B: 80 C: 8	34060863
57701	Lama posteriore L.270 SX	A: 270 B: 80 C: 8	34060862
57698	Lama posteriore L.420 DX	A: 420 B: 80 C: 8	34060859
57699	Lama posteriore L.420 SX	A: 420 B: 80 C: 8	34060858
57702	Vomero laterale 80x12x275	A: 275 B: 80 C: 12	34060850
57703	Aletta laterale L.250 DX	A: 195 B: 10	34060857
57704	Aletta laterale L.250 SX	A: 195 B: 10	34060856

ANCORE PER ESTIRPATORE

DENTS POUR CULTIVATEUR
CULTIVATOR TINES
GRUBBERZINKEN
ANCLA PARA ESTIRPADOR

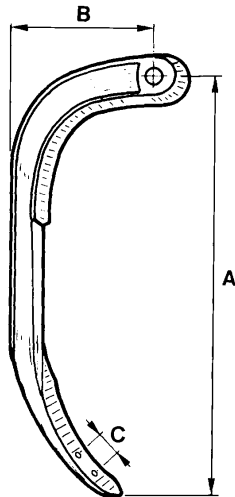

ARTICOLO	TIPO	A mm	B mm	C mm	PESO kg
55991	Media	500	290	50	6,3
55992	Pesante	570	300	50	8,5

ANCORE RIPUNTATORE LEGGERA + VOMERE

DENTS SOUS-SOLEUSE LEGERE + SOC
LIGHT SUBSOILER TINE + SHARE
ZINKEN FÜR BODENLOCKERER LEICHT + SCHAR
ANCLAS SUBSOLADOR LIGERA + REJA

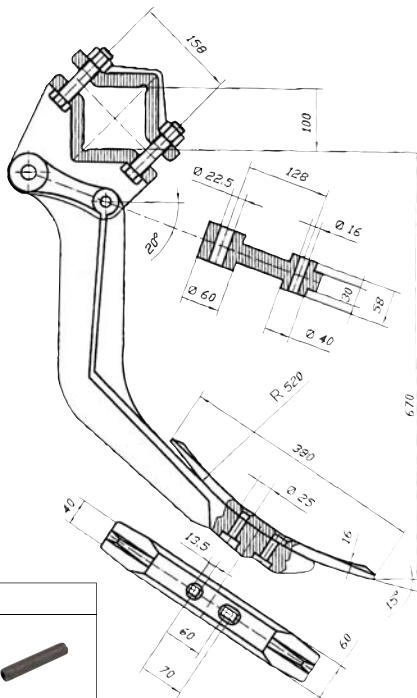

ARTICOLO
ANCORA
56756

RICAMBI

Vomere	Spina elastica
56757	57280

ANCORA RIPUNTATORE "SUPERIOR" CON STAFFA E VOMERE

DENT SOUS-SOLEUSE "SUPERIOR" AVEC ETRIER ET COUPE RACINE
SUBSOIL TINE "SUPERIOR" WITH BRACKET AND SHARE
ANKER "SUPERIOR" MIT BEFESTIGUNGSBÜGEL UND PFLUGSCHAR
ANCLA SUBSOLADOR "SUPERIOR" CON ESTRIBO Y REJA

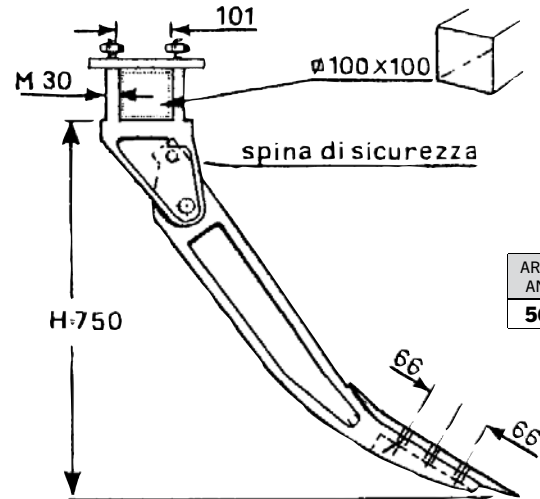

ARTICOLO
ANCORA
56610

RICAMBI

Vomere	Spina elastica
56613	57280

ANCORA TEDESCA

DENT ALLEMANDE
CULTIVATOR TINE
GRUBBERSTIEL DEUTSCHER TYP
ANCLA TEDESCA

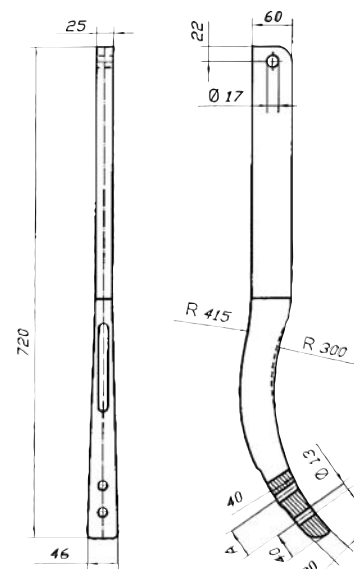

ARTICOLO	INTERASSE A
56758	70 mm
56759	45 mm

Zappe - Coltelli - Denti - Lame - Molle

BLADES - SPARE TINES FOR ROTARY HARROWS - CULTIVATOR SPRINGS

03

NASELLO PER ANCORA ESTIRPATORE

SUPPORT DENT CULTIVATEUR
FRAME FOR CULTIVATOR TINE
ANKERUNG FÜR GRUBBERZINKEN
SUPPORTE PARA ANCLA ESTIRPADOR

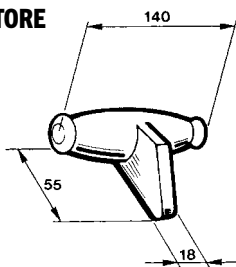

ARTICOLO
55999

CIARPA PER ANCORA ESTIRPATORE

ARRETOIR POUR CULTIVATEUR
HOLDFAST FOR CULTIVATORS
HALTERUNG FÜR GRUBBERZINKEN
RETÉN PARA ANCLA ESTIRPADOR

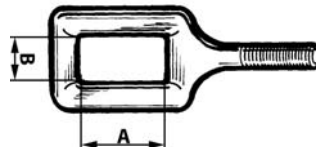

ARTICOLO	AxB	FILETTO
55997	50x20	20MA
57143	50x25	20MA
55998	60x30	22MA

MOLLA PER ANCORA ESTIRPATORE

RESSORT POUR DENT CULTIVATEUR
SPRING FOR CULTIVATOR TINE
FEDER FÜR GRUBBERZINKEN
MUELLE PARA ANCLA ESTIRPADOR

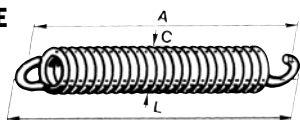

ARTICOLO	Ø FILO	L mm	A mm	C mm	B mm
55995	10 mm	317	297	52	30
55996	10 mm	355	335	52	30
56611	11 mm	297	275	55	32
56612	12 mm	346	322	58	36
56787	12 mm	383	359	62	36

MOLLA PER TILLER CON OCCHIO GIREVOLE

RESSORT POUR DENT OEIL TOURNANT
SPRINGS FOR TILLER
FEDER MIT DREHBAREN AUGEN
MUELLES PARA TILLER OJO VOLTEABLE

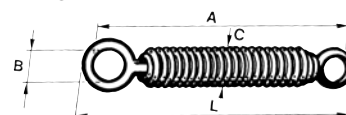

ARTICOLO	Ø FILO	L mm	A mm	C mm	B mm
55993	10 mm	355	335	52	27
55994	11 mm	357	335	52	27
56549	12 mm	440	420	60	27

VOMERINI A LANCIA PER ANCORA ESTIRPATORE CON FORO ED ASOLA

SOCS POUR DENTS CULTIVATEUR
SHARE FOR CULTIVATOR TINE
SCHAREN FÜR GRUBBERZINKEN
REJAS PARA ANCLA ESTIRPADOR

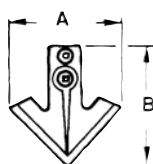

55730-55731

55833

ARTICOLO	DIMENSIONI AxB mm	Ø FORO mm	INTERASSE DA/A mm	PESO kg
55833	120x230	12	45/50	1,3
55730	200x240	12	45/50	1.5
55731	240x270	12	45/50	1.9

VOMERINO DOPPIO PER ANCORA ESTIRPATORE

SOCS DOUBLE POUR DENT CULTIVATEUR
SHARE FOR CULTIVATOR TINE
DOPPELSCHAR FÜR GRUBBERZINKEN
REJA DOBLE PARA ANCLA ESTIRPADOR

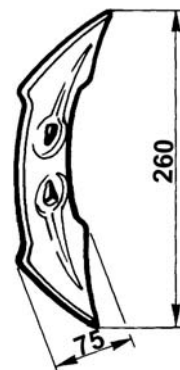

ARTICOLO	DIM. AxB mm	Ø FORO mm	INTERASSE mm
55834	260x75	12,5	45/50

VOMERE TIPO "BELGIO"

SOC TYPE "BELGIQUE"
"BELGIO" TYPE SHARE
SCHAR TYP "BELGIEN"
REJA TIPO "BELGIO"

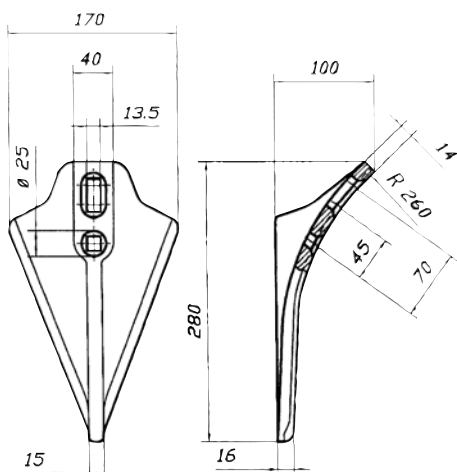

Acciaio al boro "45±2" HRC
Boron steel hardness "45±2" HRC

ARTICOLO
56760

VOMERE ZAMPA D'OCA

SOC PATTE D'OIE
DUCK FOOT SHARE
GÄNSEFUSSSCHAR
REJA SEMICIRCULAR

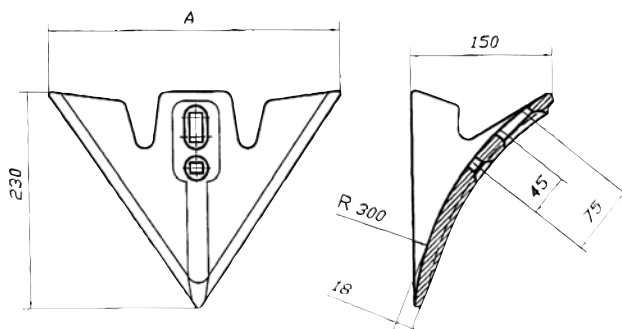

Acciaio al boro "47±2" HRC
Boron steel hardness "47±2" HRC

ARTICOLO	DIMENSIONI A
56761	310 mm
56762	420 mm

VOMERE A 3 FORI PER ANCORA 56610

SOC
SHARE
HERZFORM
REJA

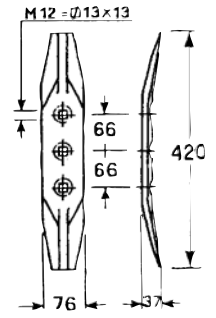

ARTICOLO	APPLICAZIONI
56613	SUPERIOR - VICON PEGORARO - PASSARDI
55382	Bullone per "SUPERIOR" M12x50

SOTTOVOMERE LARGO CURVATO

AILETTE LARGE RECOURBEE
STUBBLE SHARE
FLÜGELSCHAR KOMPLETT
APOYO REJA ANCHO CURVO



Acciaio al boro "45±2" HRC
Boron steel hardness "45±2" HRC

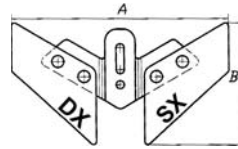

ARTICOLO	DIMENSIONI	
	A mm	B mm
56763	360	200
56764	445	240

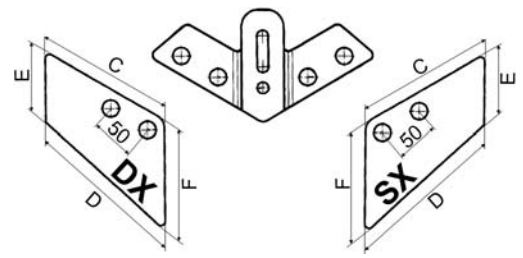

RICAMBI SOTTOVOMERE

ARTICOLO	DESCRIZIONE	C mm	D mm	E mm	F mm
56780	Corpo sottovomere	-	-	-	-
56781	Aletta DX 350	160	180	70	110
56782	Aletta SX 350	160	180	70	110
56783	Aletta DX 420	210	240	60	110
56784	Aletta SX 420	210	240	60	110

VOMERI A DOPPIO CUORE 130 MM

SOC DOUBLE COEUR 130 MM - DOUBLE HEART SHARE 130 MM - DOPPELSCHAR HERZFORM 130 MM - REJA DOBLE CORAZÓN 130 MM

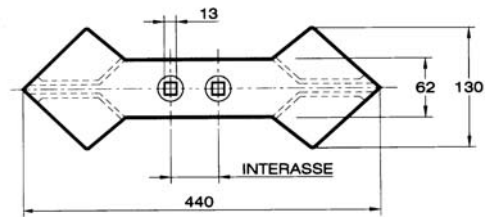
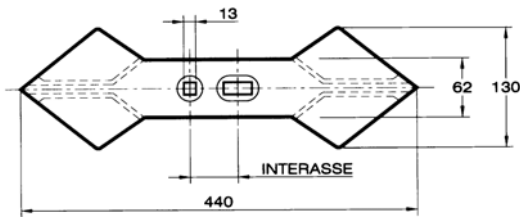

ARTICOLO	INTERASSE mm
56172	45 - 75

ARTICOLO	INTERASSE mm
56268	70
56270	45
56271	60

VOMERI A DOPPIO CUORE 180 MM

SOC DOUBLE COEUR 180 MM - DOUBLE HEART SHARE 180 MM - DOPPELSCHAR HERZFORM 180 MM - REJA DOBLE CORAZÓN 180 MM

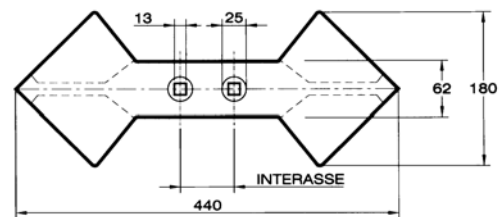
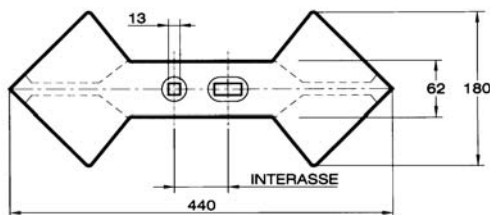

ARTICOLO	INTERASSE mm
56274	45 - 75

ARTICOLO	INTERASSE mm
56272	70
56273	45

Zappe - Coltelli - Denti - Lame - Molle

BLADES - SPARE TINES FOR ROTARY HARROWS - CULTIVATOR SPRINGS

03

03

VOMERINA PER RIPPER PEGORARO IN ACCIAIO AL BORO TEMPRATO

SOC POUR RIPPER PEGORARO EN ACIER AU BORE TREMPÉ
SHARE STEEL HARDENED BORON FOR RIPPER PEGORARO
SCHAR IN STAHL GEHÄRTET BORON FÜR RIPPER PEGORARO
REJA PARA RIPPER PEGORARO IN ACERO TEMPLADO DE BORO



ARTICOLO	LUNGHEZZA mm	PIATTO mm	Ø FORI SVASATI mm	INTERASSI FORI mm
56275	450	70x18	14,5	66 - 66
56777	450	100x15	14,5	66 - 66

SCARPETTA PER RIPUNTATORE CON ANCORA 70x18 PER ALPEGO IN ACCIAIO AL BORO TEMPRATO

RASETTE POUR SOUS-SOLEUSE AVEC DENT DE 70X18 MM POUR ALPEGO EN ACIER AU BORE TREMPÉ
SUBSOILER'S SHOE WITH 70X18 MM TINE STEEL HARDENED BORON, FOR ALPEGO
TIEFNEMEISSELSSCHUH IN STAHL GEHÄRTET BORON MIT ANKER 70X18 MM PASSEND FÜR ALPEGO
DIENTE SUBSOLADOR IN ACERO TEMPLADO DE BORO CON ANCLA 70 X18 MM PARA ALPEGO



ARTICOLO	H mm	L mm	S mm
57421	470	70	18

VOMERINE TRIANGOLARI DA FORARE IN ACCIAIO AL CARBONIO

SOCs TRIANGULAIRE A FORER EN ACIER AU CARBONE
TRIANGLE STEEL SHARE TO PIERCE
DREIECKIG SCHAR IN KOHLENSTOFFSTAHL ZU LOCHEN
REJA TRIANGULAR DE AGUJEREAR IN ACERO AL CARBONO

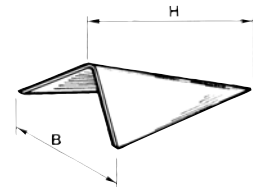

ARTICOLO	B mm	H mm
56111	220	220
56112	240	240
56113	270	270
56114	300	300

SCALPELLI PER MASCHIO IN ACCIAIO AL BORO TEMPRATO

RASETTE POUR MASCHIO EN ACIER AU BORE TREMPÉ
CHISELS STEEL HARDENED BORON FOR MASCHIO
MEIBEL IN STAHL GEHÄRTET BORON FÜR MASCHIO
CINCEL PARA MASCHIO IN ACERO TEMPLADO DE BORO



ARTICOLO	DIMENSIONI mm	SEDE PER ANCORA (A) mm	OEM
57392	460x70x20	37	17820660 17820661
57393	460x70x20	32	17820680

SCARPETTA PER RIPUNTATORE CON ANCORA 70x15 PER ALPEGO IN ACCIAIO AL BORO TEMPRATO

RASETTE POUR SOUS-SOLEUSE AVEC DENT DE 70X15 MM POUR ALPEGO EN ACIER AU BORE TREMPÉ
SUBSOILER'S SHOE WITH 70X15 MM TINE, STEEL HARDENED BORON FOR ALPEGO
TIEFNEMEISSELSSCHUH IN STAHL GEHÄRTET BORON MIT ANKER 70X15 MM PASSEND FÜR ALPEGO
DIENTE SUBSOLADOR IN ACERO TEMPLADO DE BORO CON ANCLA 70 X15 MM PARA ALPEGO

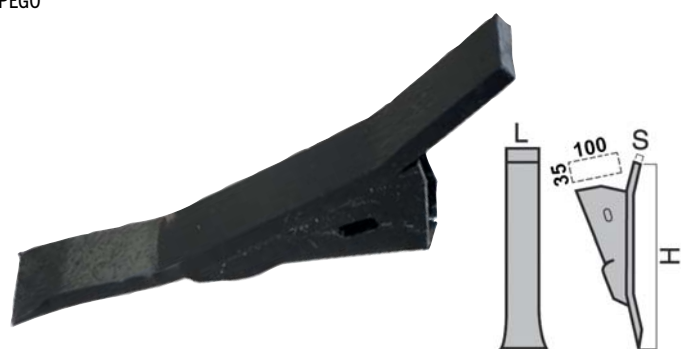

ARTICOLO	H mm	L mm	S mm
57422	400	70	15

SPUNTONE PER RULLO POSTERIORE - da saldare

POINTE POUR ROULEAU ARRIERE - à souder
 REAR ROLLER SPIKE - to be welded
 ANSCHWEISSSPITZE FÜR NACHLAUFWALZE
 PUA PARA RODILLO TRASERO - a soldar

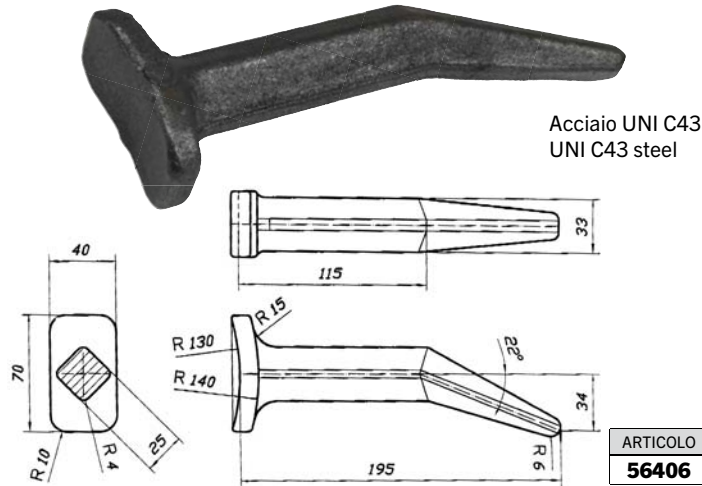

TRIDENTE PER ERPICI TIPO «HOWARD»

TRIDENT POUR HERSE «HOWARD»
 TRIDENT FOR HARROWS «HOWARD»
 EGGENZINKE TYP «HOWARD»
 TRIDIENTES PARA GRADAS DE DIENTES TIPO «HOWARD»



ARTICOLO	MATERIALE	PESO kg
55857	Acciaio	1,650

BULLONI A TESTA SVASATA E QUADRO SOTTOTESTA PER VOMERINI CON DADO ESAGONALE

VIS TETE RONDE POUR SOCS
 FLARED ROUND HEAD SCREW FOR SHARES
 KONISCHE RUNDSCHRAUBE FÜR SCHAREN
 TORNILLOS CABEZA REDONDA CÓNICA PARA REJAS



ARTICOLO	DIMENSIONI mm
55837	10x30
55982	10x40
55983	10x45
55166	10x50
55838	10x70
55382	12x50
55990	12x55
55835	12x60
55836	12x70
57598	12x90

ASSOLCATORE PER MOTOZAPPA REGOLABILE

RIGOLEUSES POUR MOTOHOUES
 BEDDERS FOR MOTOR HOES
 FURCHENZIEHER FÜR MOTORHACKEN
 SURCADORES PARA MOTOAZADAS



Apertura Massima 540 mm

ARTICOLO	DESCRIZIONE
55910	Attacco sperone 25x8 mm
55911	Attacco sperone 30x10 mm
55912	Attacco sperone 35x10 mm
55913	Attacco sperone 40x10 mm

PIASTRE DENTATE PER RUSPE LIVELLATRICI

PLAQUES DENTÉES POUR LAMES NIVELLEUSES
 PLATES FOR REAR SCHRAPERES
 ZAHNPLATTE FÜR PLANIERSCHAUFELN
 PLACAS DENTADAS PARA TRAILLAS NIVELADORA



55852



55853
55854

ARTICOLO	Ø mm	DENTI	NOTE
55852	186	18	Senza foro
55853	240	18	Foro Ø 60 mm
55854	320	24	Foro Ø 80 mm

Zappe - Coltelli - Denti - Lame - Molle

BLADES - SPARE TINES FOR ROTARY HARROWS - CULTIVATOR SPRINGS

03

03

PUNTE PER CARICATORI DI ROTOBALLE

DENTS POUR CHARGEUR A BALLES RONDES - TINES FOR ROUND BALE LOADERS - ZINKEN FÜR ROLLBALLEN - DIENTES PARA CARGADOR DE PACAS

PUNTA CONICA Ø 36x1100 mm COMPLETA DI DADO

POINTE CONIQUE Ø 36x1100 mm AVEC ECROU
 Ø 36x1100 mm TAPERED TINE COMPLETE WITH NUT
 KEGELSPITZE Ø 36x1100 mm MIT MUTTER
 PUNTA CONICA Ø 36x1100 mm CON TUERCA

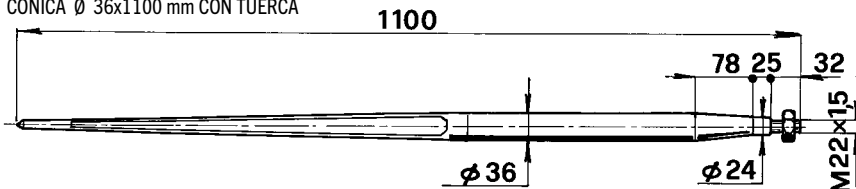

ARTICOLO
55839

BUSSOLA CONICA

DOUILLE CONIQUE
 TAPERED BUSHING
 KEGELBUCHSE
 MANGUITO CÓNICO



ARTICOLO
55848

PUNTA CONICA Ø 36x1200 mm COMPLETA DI DADO

POINTE CONIQUE Ø 36x1200 mm AVEC ECROU
 Ø 36x1200 mm TAPERED TINE COMPLETE WITH NUT
 KEGELSPITZE Ø 36x1200 mm MIT MUTTER
 PUNTA CONICA Ø 36x1200 mm CON TUERCA

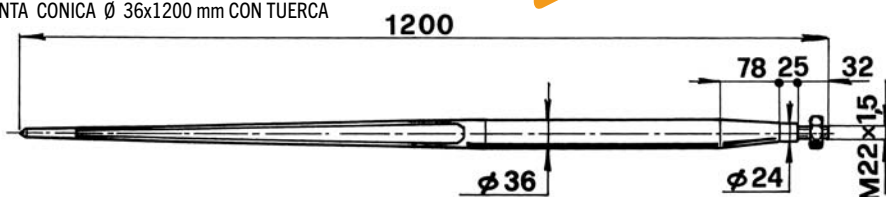

ARTICOLO
57595

BUSSOLA CONICA

DOUILLE CONIQUE
 TAPERED BUSHING
 KEGELBUCHSE
 MANGUITO CÓNICO



ARTICOLO
55848

PUNTA CONICA Ø 36x1400 mm COMPLETA DI DADO

POINTE CONIQUE Ø 36x1400 mm AVEC ECROU
 Ø 36x1400 mm TAPERED TINE COMPLETE WITH NUT
 KEGELSPITZE Ø 36x1400 mm MIT MUTTER
 PUNTA CONICA Ø 36x1400 mm CON TUERCA

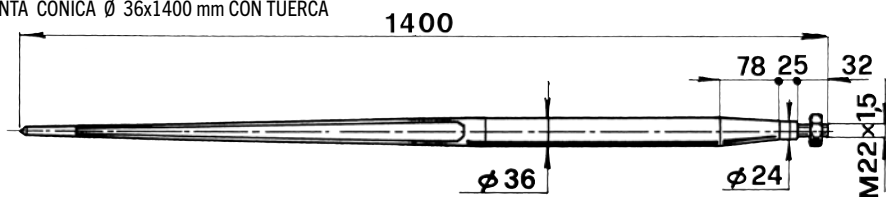

ARTICOLO
55840

BUSSOLA CONICA

DOUILLE CONIQUE
 TAPERED BUSHING
 KEGELBUCHSE
 MANGUITO CÓNICO



ARTICOLO
55848

PUNTA CONICA Ø 42x900 mm COMPLETA DI DADO

POINTE CONIQUE Ø 42x900 mm AVEC ECROU
 Ø 42x900 mm TAPERED TINE COMPLETE WITH NUT
 KEGELSPITZE Ø 42x900 mm MIT MUTTER
 PUNTA CONICA Ø 42x900 mm CON TUERCA

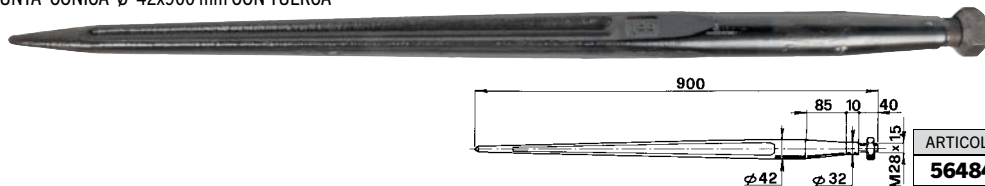

ARTICOLO
56484

BUSSOLA CONICA

DOUILLE CONIQUE
 TAPERED BUSHING
 KEGELBUCHSE
 MANGUITO CÓNICO



ARTICOLO
55849

PUNTA CONICA Ø 42x1100 mm COMPLETA DI DADO

POINTE CONIQUE Ø 42x1100 mm AVEC ECROU
 Ø 42x1100 mm TAPERED TINE COMPLETE WITH NUT
 KEGELSPITZE Ø 42x1100 mm MIT MUTTER
 PUNTA CONICA Ø 42x1100 mm CON TUERCA

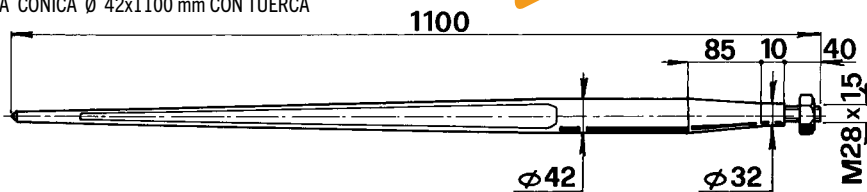

ARTICOLO
57594

BUSSOLA CONICA

DOUILLE CONIQUE
 TAPERED BUSHING
 KEGELBUCHSE
 MANGUITO CÓNICO



ARTICOLO
55849

PUNTA CONICA Ø 42x1200 mm COMPLETA DI DADO

POINTE CONIQUE Ø 42x1200 mm AVEC ECROU
 Ø 42x1200 mm TAPERED TINE COMPLETE WITH NUT
 KEGELSPITZE Ø 42x1200 mm MIT MUTTER
 PUNTA CONICA Ø 42x1200 mm CON TUERCA

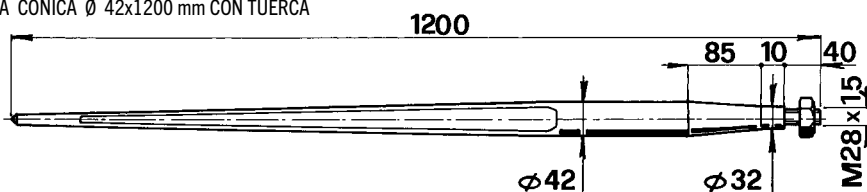

ARTICOLO
56485

segue PUNTE PER CARICATORI DI ROTOBALLE

DENTS POUR CHARGEUR A BALLE RONDES - TINES FOR ROUND BALE LOADERS - ZINKEN FÜR ROLLBALLEN - DIENTES PARA CARGADOR DE PACAS

PUNTA CONICA Ø 42x1400 mm COMPLETA DI DADO

POINTE CONIQUE Ø 42x1400 mm AVEC ECROU
Ø 42x1400 mm TAPERED TINE COMPLETE WITH NUT
KEGELSPITZE Ø 42x1400 mm MIT MUTTER
PUNTA CONICA Ø 42x1400 mm CON TUERCA

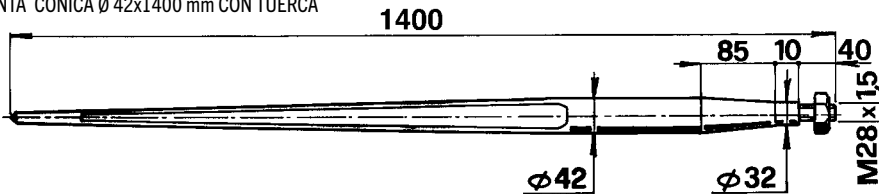

ARTICOLO
55842

BUSSOLA CONICA

DOUILLE CONIQUE
TAPERED BUSHING
KEGELBUCHSE
MANGUITO CÓNICO



ARTICOLO
55849

PUNTA CONICA Ø 45x820 mm COMPLETA DI DADO

POINTE CONIQUE Ø 45x820 mm AVEC ECROU
Ø 45x820 mm TAPERED TINE COMPLETE WITH NUT
KEGELSPITZE Ø 45x820 mm MIT MUTTER
PUNTA CONICA Ø 45x820 mm CON TUERCA

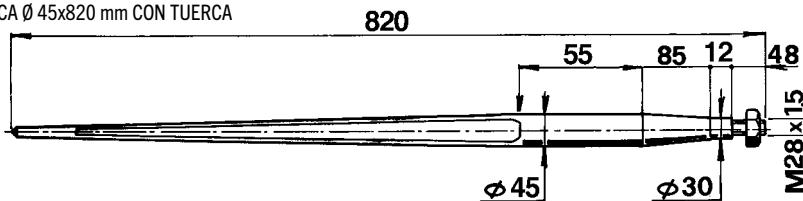

ARTICOLO
56770

BUSSOLA CONICA

DOUILLE CONIQUE
TAPERED BUSHING
KEGELBUCHSE
MANGUITO CÓNICO



ARTICOLO
56775

PUNTA CONICA Ø 45x980 mm COMPLETA DI DADO

POINTE CONIQUE Ø 45x980 mm AVEC ECROU
Ø 45x980 mm TAPERED TINE COMPLETE WITH NUT
KEGELSPITZE Ø 45x980 mm MIT MUTTER
PUNTA CONICA Ø 45x980 mm CON TUERCA

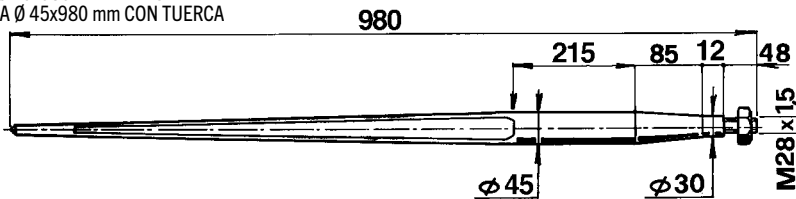

ARTICOLO
56771

BUSSOLA CONICA

DOUILLE CONIQUE
TAPERED BUSHING
KEGELBUCHSE
MANGUITO CÓNICO



ARTICOLO
56775

PUNTA CONICA Ø 45x1250 mm COMPLETA DI DADO

POINTE CONIQUE Ø 45x1250 mm AVEC ECROU
Ø 45x1250 mm TAPERED TINE COMPLETE WITH NUT
KEGELSPITZE Ø 45x1250 mm MIT MUTTER
PUNTA CONICA Ø 45x1250 mm CON TUERCA

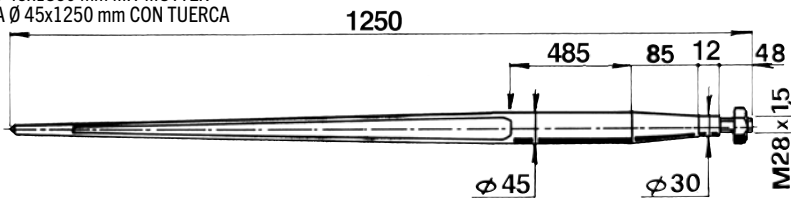

ARTICOLO
56772

BUSSOLA CONICA

DOUILLE CONIQUE
TAPERED BUSHING
KEGELBUCHSE
MANGUITO CÓNICO



ARTICOLO
56775

PUNTA CILINDRICA Ø 36x1100 mm TIPO FORATO

POINTE CYLINDRIQUE Ø 36x1100 mm TYPE PERCE
Ø 36x1100 mm CYLINDRICAL TINE - TYPE WITH HOLE
ZYLINDERSPITZE Ø 36x1100 mm GELOCHTER TYP
PUNTA CILINDRICA Ø 36x1100 mm TIPO PERFORADO



ARTICOLO
56773

PUNTA CILINDRICA Ø 40x1310 mm TIPO FORATO PER SIGMA

POINTE CYLINDRIQUE Ø 40x1310 mm TYPE PERCE
Ø 40x1310 mm CYLINDRICAL TINE - TYPE WITH HOLE
ZYLINDERSPITZE Ø 40x1310 mm GELOCHTER TYP
PUNTA CILINDRICA Ø 40x1310 mm TIPO PERFORADO

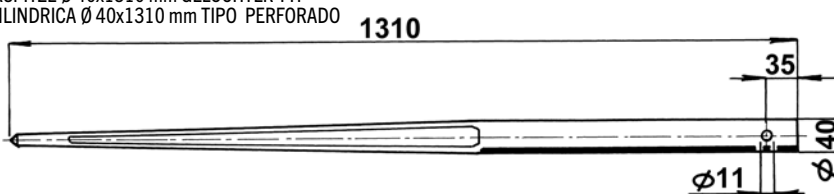

ARTICOLO
57222

Zappe - Coltelli - Denti - Lame - Molle

BLADES - SPARE TINES FOR ROTARY HARROWS - CULTIVATOR SPRINGS

03

03

segue PUNTE PER CARICATORI DI ROTOBALLE

DENTS POUR CHARGEUR A BALLES RONDES - TINES FOR ROUND BALE LOADERS - ZINKEN FÜR ROLLBALLEN - DIENTES PARA CARGADOR DE PACAS

PUNTA CILINDRICA Ø 36x1400 mm TIPO FORATO

POINTE CYLINDRIQUE Ø 36x1400 mm TYPE PERCE
 Ø 36x1400 mm CYLINDRICAL TINE - TYPE WITH HOLE
 ZYLINDERSPITZE Ø 36x1400 mm GELOCHTER TYP
 PUNTA CILINDRICA Ø 36x1400 mm TIPO PERFORADO

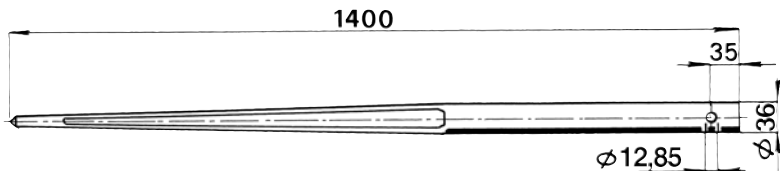

ARTICOLO
56774

PUNTA CILINDRICA Ø 42x1400 mm TIPO FORATO

POINTE CYLINDRIQUE Ø 42x1400 mm TYPE PERCE
 Ø 42x1400 mm CYLINDRICAL TINE - TYPE WITH HOLE
 ZYLINDERSPITZE Ø 42x1400 mm GELOCHTER TYP
 PUNTA CILINDRICA Ø 42x1400 mm TIPO PERFORADO

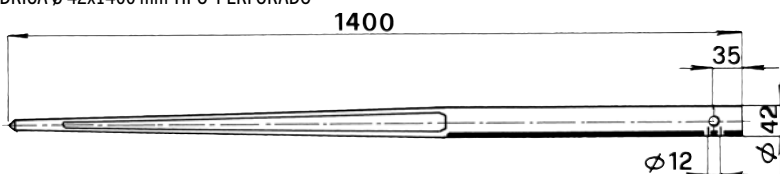

ARTICOLO
55843

BUSSOLA CILINDRICA

DOUILLE CYLINDRIQUE
 STRAIGHT BUSHING
 ZYLINDERBUCHSE
 MANGUITO CILINDRICO

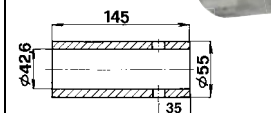
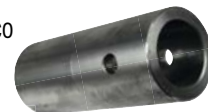

ARTICOLO
56486

PUNTE PER CARICATORI DI ROTOBALLE - PRODUZIONE ESTERA AMK

DENTS POUR CHARGEUR A BALLES RONDES
 TINES FOR ROUND BALE LOADERS
 ZINKEN FÜR ROLLBALLEN
 DIENTES PARA CARGADOR DE PACAS

PUNTA CONICA Ø 36x1400 mm COMPLETA DI DADO PRODUZIONE AMK - COLORE ROSSO

POINTE CONIQUE Ø 36x1400 mm AVEC EROU PRODUCTION AMK - COULEUR ROUGE
 Ø 36x1400 mm TAPERED TINE COMPLETE WITH NUT - AMK PRODUCTION - RED COLOR
 KEGELSPITZE Ø 36x1400 mm MIT MUTTER PRODUKTION AMK - ROTE FARBE
 PUNTA CONICA Ø 36x1400 mm CON TUERCA PRODUCCIÓN AMK - COLOR ROJO

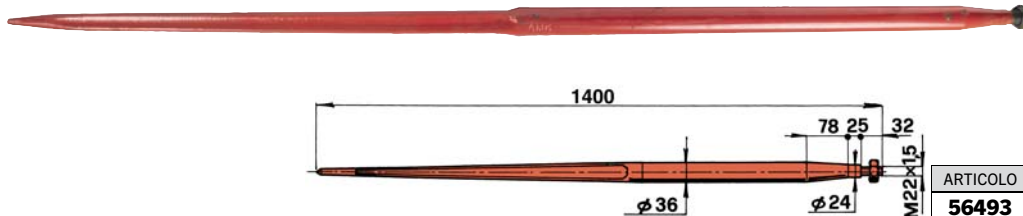

ARTICOLO
56493

BUSSOLA CONICA

DOUILLE CONIQUE
 TAPERED BUSHING
 KEGELBUCHSE
 MANGUITO CÓNICO

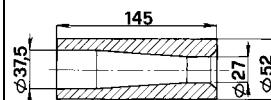

ARTICOLO
55848

PUNTA CONICA Ø 36x1100 mm COMPLETA DI DADO PRODUZIONE AMK - COLORE ROSSO

POINTE CONIQUE Ø 36x1100 mm AVEC EROU PRODUCTION AMK - COULEUR ROUGE
 Ø 36x1100 mm TAPERED TINE COMPLETE WITH NUT - AMK PRODUCTION - RED COLOR
 KEGELSPITZE Ø 36x1100 mm MIT MUTTER PRODUKTION AMK - ROTE FARBE
 PUNTA CONICA Ø 36x1100 mm CON TUERCA PRODUCCIÓN AMK - COLOR ROJO

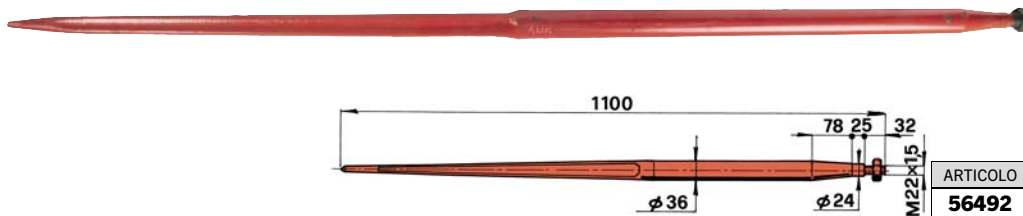

ARTICOLO
56492

BUSSOLA CONICA

DOUILLE CONIQUE
 TAPERED BUSHING
 KEGELBUCHSE
 MANGUITO CÓNICO

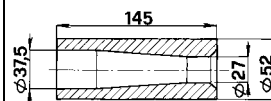

ARTICOLO
55848

DADI PER PUNTE

ECROU - NUTS - MUTTER - DADO

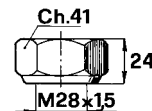
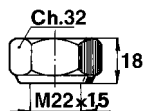

ARTICOLO	APPLICAZIONI
55858	PER PUNTE Ø 36 mm

ARTICOLO	APPLICAZIONI
55859	PER PUNTE Ø 42 mm

PUNTE PER FORCA LETAME

DENTS POUR CHARGEUR - TINES FOR LOADERS - ZINKEN ZUM LADEN - DIENTES RECTOS PARA HORQUILLAS ESTIÉRCOL

PUNTA Ø 36x800 mm COMPLETA DI DADO PER CARICATORE FRONTALE

POINTE Ø 36x800 mm AVEC ECROU POUR CHARGEUR FRONTAL
 Ø 36x800 mm TINE COMPLETE WITH NUT FOR FRONT LOADERS
 SPITZE Ø 36x800 mm MIT MUTTER FÜR FRONTLADER
 PUNTA Ø 36x800 mm CON TUERCA PARA CARGADOR FRONTAL

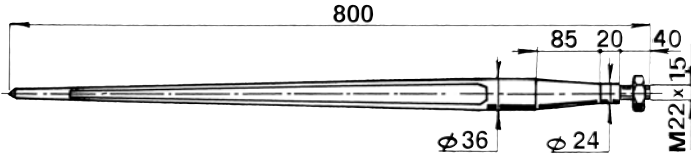

ARTICOLO
55845

BUSSOLA CONICA

DOUILLE CONIQUE
 TAPERED BUSHING
 KEGELBUCHSE
 MANGUITO CÓNICO

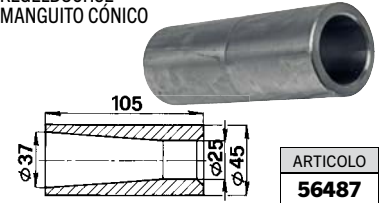

ARTICOLO
56487

PUNTA DISASSATA Ø 36x880 mm COMPLETA DI DADO PER CARICATORE FRONTALE

POINTE DESAXÉE Ø 36x880 mm AVEC ECROU POUR CHARGEUR FRONTAL
 Ø 36x880 mm MISALIGNED TINE COMPLETE WITH NUT FOR FRONT LOADERS
 VERSETZTE SPITZE Ø 36x880 mm MIT MUTTER FÜR FRONTLADER
 PUNTA DESFASADA Ø 36x880 mm CON TUERCA PARA CARGADOR FRONTAL

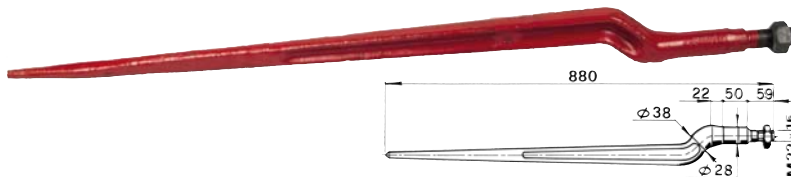

ARTICOLO
55844

BUSSOLA CONICA

DOUILLE CONIQUE
 TAPERED BUSHING
 KEGELBUCHSE
 MANGUITO CÓNICO

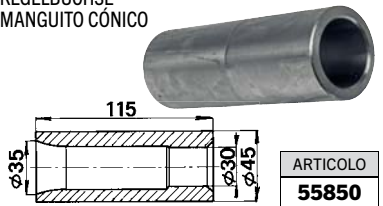

ARTICOLO
55850

PUNTA 35x24x780 mm DA SALDARE PER FORCA LETAME

POINTE DE SOUDER 35X24X780 mm POUR FOURCHE DE FUMIER
 35X24X780 mm MANURE FORK'S TINE TO BE WELDED
 SPITZE 35X24X780 mm FÜR DÜNGGABEL, GESCHWEIßT WERDEN
 PUNTA DE SOLDAR 35X24X780 mm PARA FUERCA DE ESTÉRCOL

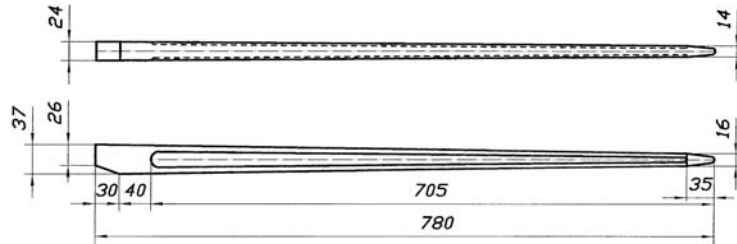

ARTICOLO
57457

PUNTA 30x900 mm DA SALDARE PER FORCA LETAME

POINTE DE SOUDER 30X900 mm POUR FOURCHE DE FUMIER
 30X900 mm MANURE FORK'S TINE, TO BE WELDED
 SPITZE 30X900 mm FÜR DÜNGGABEL, GESCHWEIßT WERDEN
 PUNTA DE SOLDAR 30X900 mm PARA FUERCA DE ESTÉRCOL

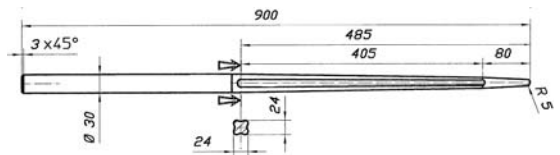

ARTICOLO
57458

DENTI PER FORCONE

DENT POUR CHARGEUR
 TINE FOR LOADER
 GREIFERZINKE
 DIENTES PARA HORQUILLA

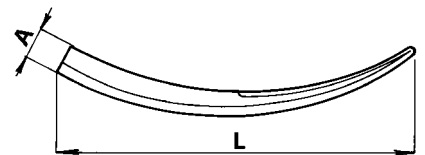

ARTICOLO	TIPO	A mm	L mm
55846	Leggero	47	540
55847	Pesante	56	600

PUNTE PER FORCA LETAME CURVE

DENT POUR CHARGEUR MOD. COUBRE
 TINE FOR LOADER
 ZINKE ZUM LADEN
 DIENTES CURVOS PARA
 HORQUILLAS ESTIÉRCOL

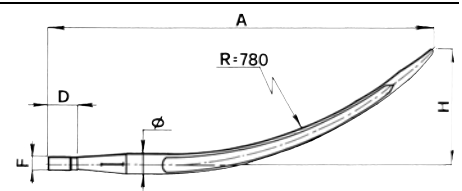

ARTICOLO	Ø mm	A mm	D mm	F mm	H mm	BUSSOLA
56488	36	600	40	H 22	85	56487
56489	36	810	40	H 22	210	

Zappe - Coltelli - Denti - Lame - Molle

BLADES - SPARE TINES FOR ROTARY HARROWS - CULTIVATOR SPRINGS

03

03

FORCA PER TRASPORTO BALLE

FOURCHE DE TRANSPORT BALLES
BALE TRANSPORT FORK
BALLENGABEL
HORQUILLA PARA TRANSPORTE PACAS

new



CARATTERISTICHE

- CAPACITÀ DI CARICO: 800 Kg
- CATEGORIA: 1-2

PUNTE (da ordinare a parte)

Punta conica compresa di dado		
Ø 36x1100 mm	Ø 36x1400 mm	Ø 36x1200 mm
55839	55840	57595

ARTICOLO
57707

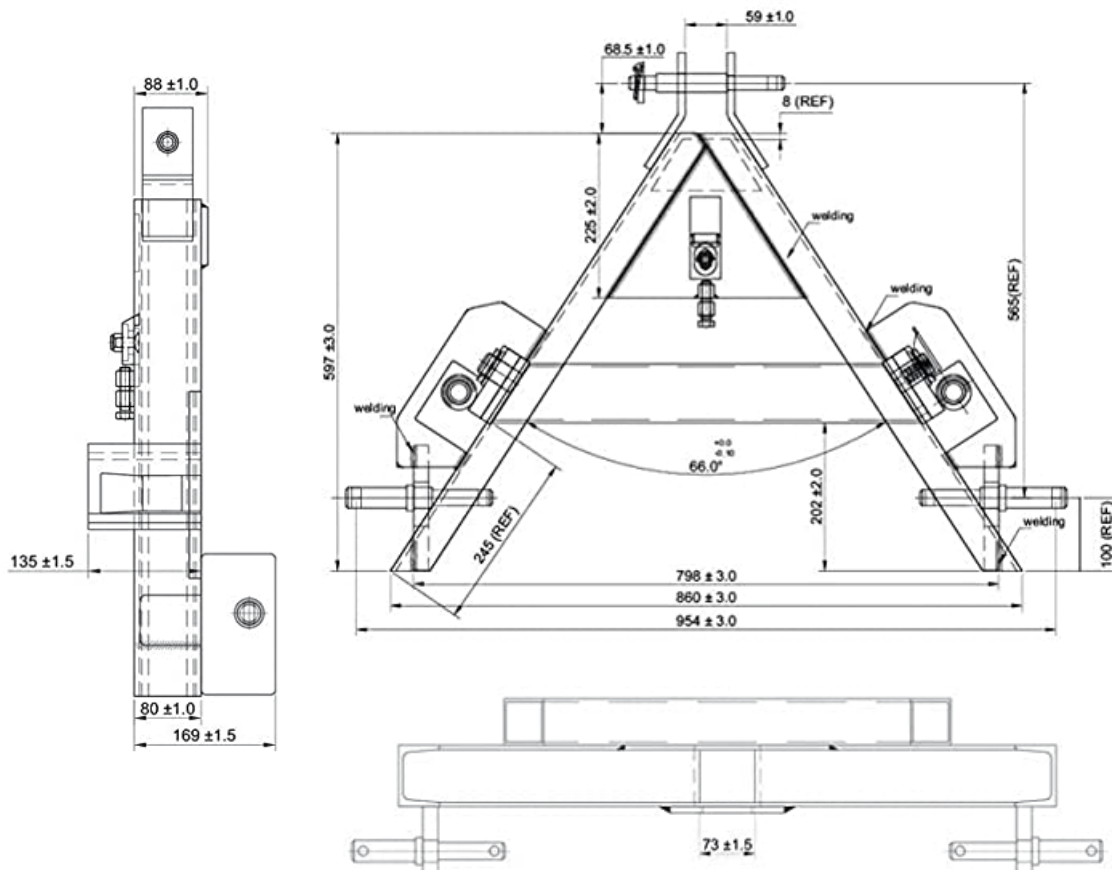

DENTI PER GIRELLO

DENTS FANEUR - ROUND FINGERS - ZINKEN - MUELLES

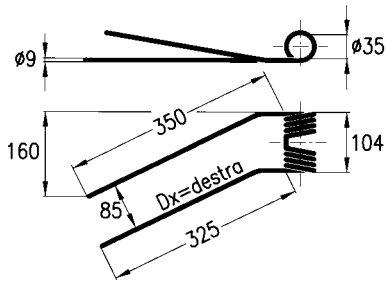

ARTICOLO	MANO	APPLICAZIONI	OEM
55617	DX	GALFRÈ n° 1 -	108 SV
55622	SX	MORRA - FELLA	107 SV

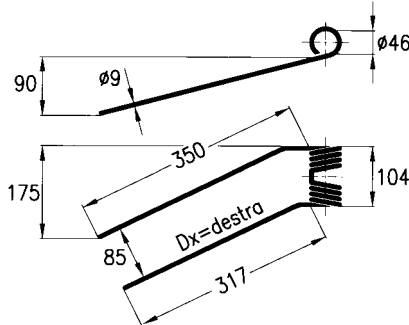

ARTICOLO	MANO	APPLICAZIONI	OEM
55637	DX	LINCE 1ª - 2ª - 3ª Serie	
55638	SX	Dente a ricciolo grande Ø 46	

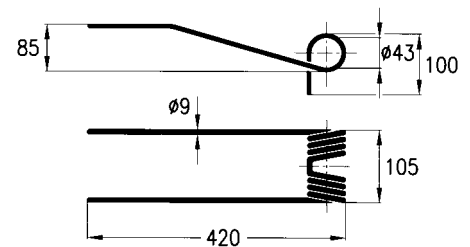

ARTICOLO	APPLICAZIONI	OEM
55873	GALFRÈ n° 2 - Mod. GTS	GALFRÈ 38

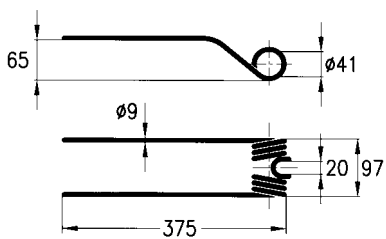

ARTICOLO	APPLICAZIONI	OEM
55616	FAHR n° 2 tipo nuovo MORRA	1.1043.030.107.00

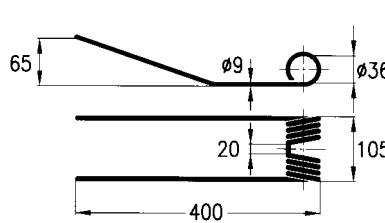

ARTICOLO	APPLICAZIONI	OEM
55635	FORT standard	

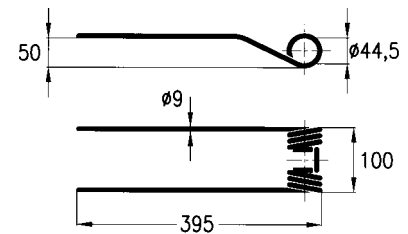

ARTICOLO	APPLICAZIONI	OEM
55634	FONTANESI standard FRANDENT ADATTABILE SLAM n° 1	

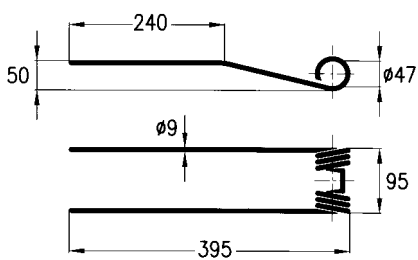

ARTICOLO	APPLICAZIONI	OEM
55639	OLIVI - MOLON - OMA/ITALIA	

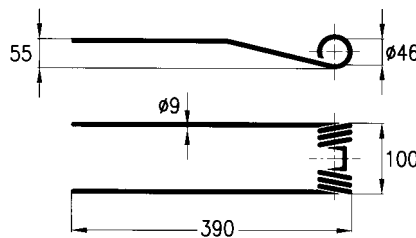

ARTICOLO	APPLICAZIONI	OEM
56410	SLAM n° 2 - FONTANESI n° 2 Dente a ricciolo grande Ø 46	

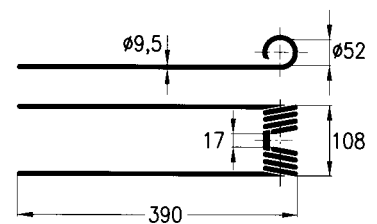

ARTICOLO	APPLICAZIONI	OEM
56362	KHUN n° 2 a ricciolo grande Ø 52	58561900

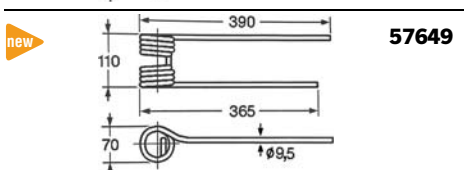
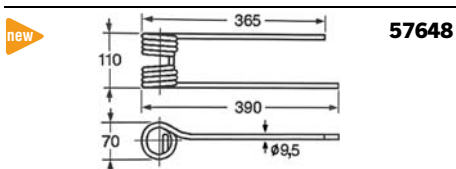

ARTICOLO	APPLICAZIONI KUHN	OEM
57648	Destro	58740700
57649	Sinistro	58740600

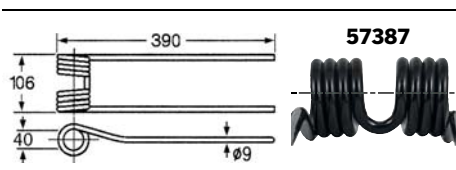
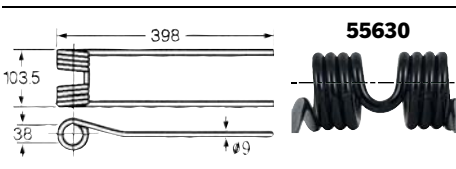

ARTICOLO	APPLICAZIONI BCS / MAINARDI	OEM
55630	Modello std (vecchio)	4036
57387	Modello std (nuovo)	

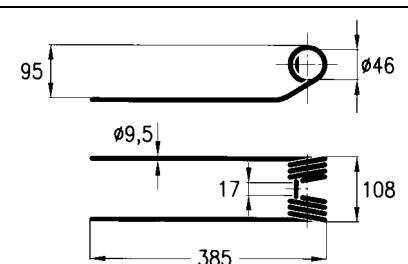

ARTICOLO	APPLICAZIONI	OEM
55874	KHUN n° 1 GF 4 - 4 SP, GF 22 SP, GF 23, GF 440 M (fino a 800350), GF 452 M/P/T (fino a 803200), GF 440 P/T (fino a 805100)	58505214 58505210

segue DENTI PER GIRELLO

DENTS FANEUR - ROUND FINGERS - ZINKEN - MUELLES

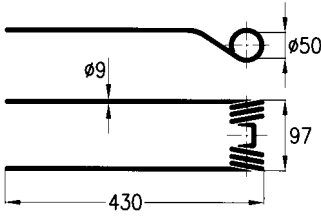

ARTICOLO	APPLICAZIONI	OEM
55626	GALFRÈ n° 4 - Costruzione 1987. Attacco superiore	67/88

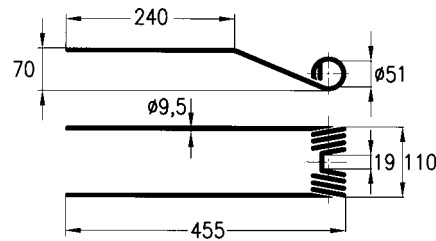

ARTICOLO	APPLICAZIONI	OEM
56411	GALFRÈ n° 5 - 1988 Mod. 400 - 420 - 450 GTS - 520 - Attacco inferiore	67/88

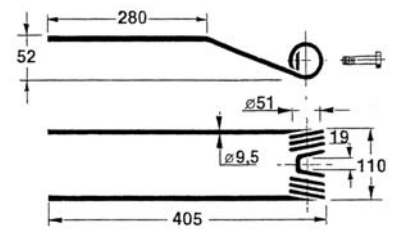

ARTICOLO	APPLICAZIONI	OEM
56571	GALFRÈ n° 6 - 1994 Mod. 400-420-450-480GTS-520- Attacco inferiore	67/46

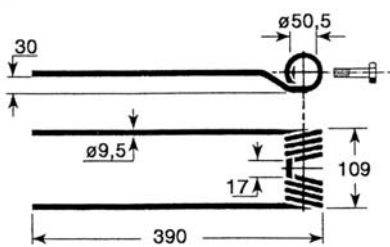

ARTICOLO	APPLICAZIONI	OEM
56550	KUHN n° 3 - Mod.: GF22 NP/NT GF3701-4000MT-4201MH-440-5000/1-6000/1-6301-7000-GRS24	57609000

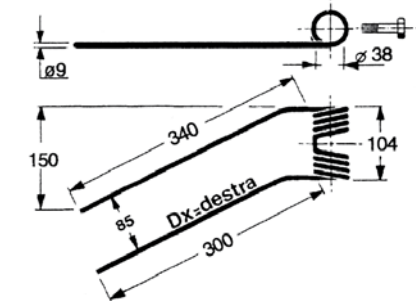

ARTICOLO	MANO	APPLICAZIONI	OEM
56614	DX	FELLA TH 4 S/DS, TH 6 S/DS, TH 330 D, TH 380, TH 460, TH 670	460182 487134
56615	SX		460181 487133

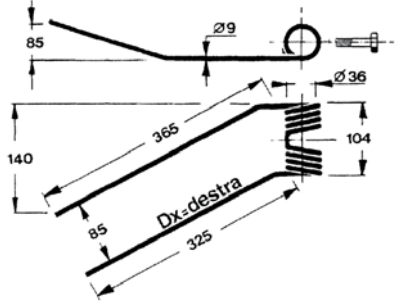

ARTICOLO	MANO	APPLICAZIONI	OEM
56616	DX	FAHR n°1 KH 2/4/6	1104000150010 06229776
56617	SX	VICON	1104000150110 0658 0391

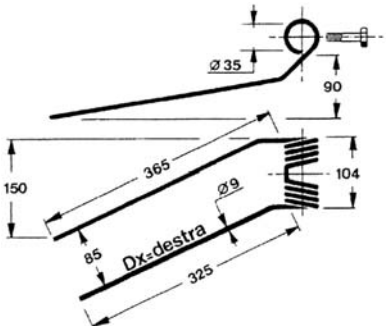

ARTICOLO	MANO	APPLICAZIONI
56618	DX	SUPERTINO Tipo vecchio
56619	SX	

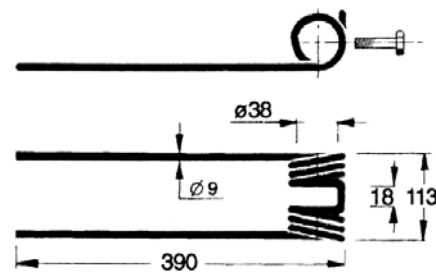

ARTICOLO	APPLICAZIONI	OEM
56620	ITALO SVIZZERA	RS 019

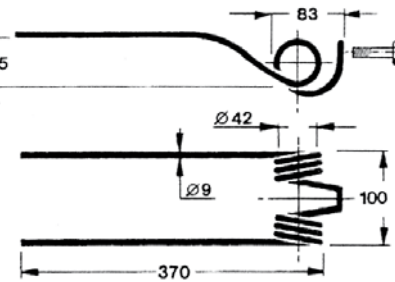

ARTICOLO	APPLICAZIONI	OEM
56621	GALFRÈ n°3	67/87

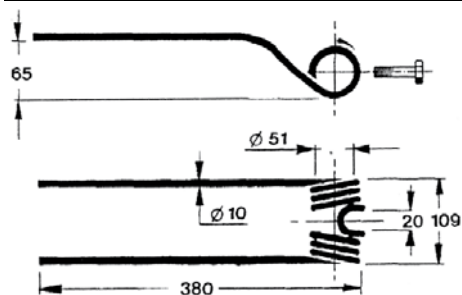

ARTICOLO	APPLICAZIONI	OEM
56622	MORRA/FORT n°3 Mod. MH 420-530	MH420-530
	FAHR TIPO NUOVO Mod. KH3.52-3.55 Super	1650.2744 0656.5574

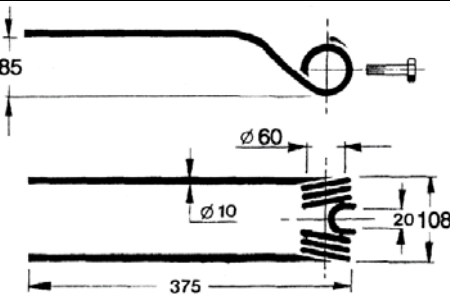

ARTICOLO	APPLICAZIONI	OEM
56623	FAHR N°4 Tipo nuovo KVERNELAND - PZ - TAARUP - VICON	16607564 VF1660756486 1660756486

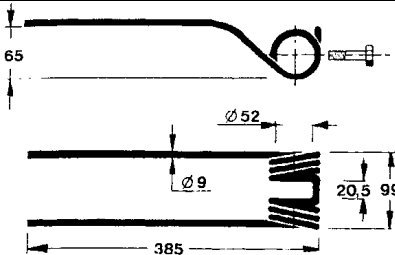

ARTICOLO	APPLICAZIONI	OEM
56624	FELLA N°2 TH 275 D, TH 431 D, TH 450 D Hyd., TH 520 D, TH 540 D Hyd., TH 660 D Hyd., TH 680 D Hyd., TH 700; 700D, TH 790 Hyd., TH 800 Hyd.; 800 D Hyd., TH 900 D; TH 901, TH 1100 Hyd.; TH 1101, TH 1300 Hyd., TH 1550, TH 1800	126167 150862 487734 487922

segue DENTI PER GIRELLO
DENTS FANEUR - ROUND FINGERS - ZINKEN - MUELLES

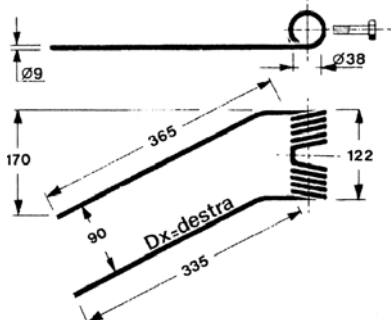

ARTICOLO	MANO	APPLICAZIONI	OEM
56625	DX	MORRA n°4 DX/SX a 5 spire	26 10 00 04
56626	SX	FELLA-BAUTZ	26 05 00 15

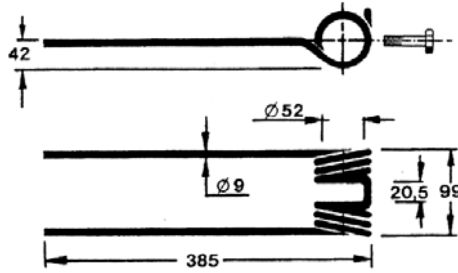

ARTICOLO	APPLICAZIONI	OEM
56627	FELLA n°3 TH 360; 360 D; 360 DS, TH 370; 370 D; 370 DS, TH 400 DN/DS; 401 DS, TH 410; 410 D, TH 430; 430 D, TH 440; 440 D, TH 601 D, TZ 180 D	124966 150296 488072

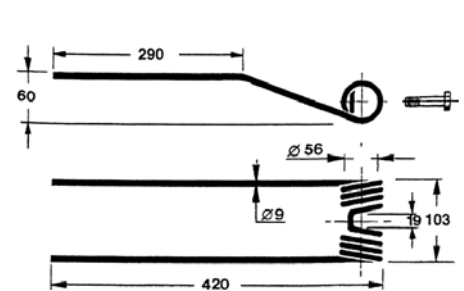

ARTICOLO	APPLICAZIONI
56628	LINCE n°2 TIPI ATTUALI N.B.: versione migliorata nel 1992 con l'aggiunta di una spira e dell'attacco sotto piatto.

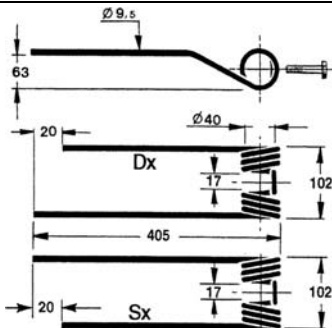

ARTICOLO	MANO	APPLICAZIONI	OEM
56629	DX	CLAAS n°1 Mod.	902.483.2
56630	SX	W-WA-WAS/450-540	902.482.2

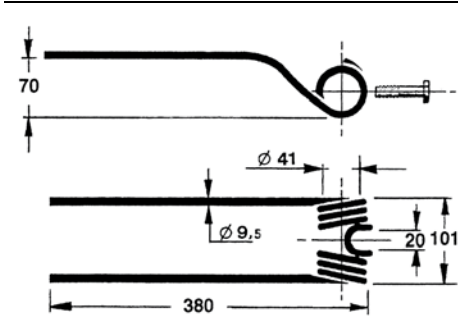

ARTICOLO	APPLICAZIONI	OEM
56631	CLAAS n°2 Mod. W-WA-WAS/450-540	902.344.2

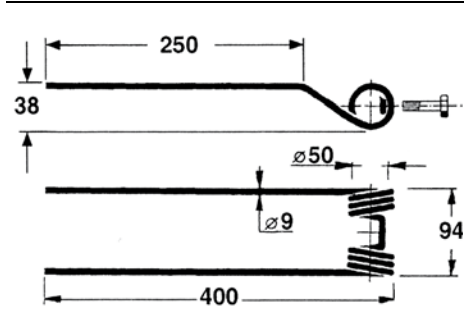

ARTICOLO	APPLICAZIONI
56632	IMA LAROCCA n°1 Costruzione 1996-1999

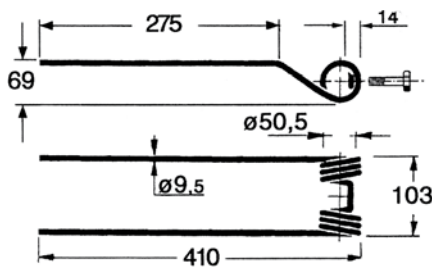

ARTICOLO	APPLICAZIONI
56633	IMA LAROCCA n°2 Costruzione dal 2000

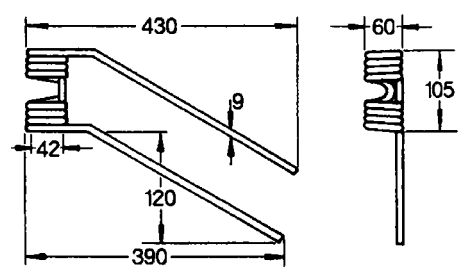

In figura è rappresentata la versione DX

ARTICOLO	MANO	APPLICAZIONI
56881	DX	FCR - GASPARDO
56882	SX	

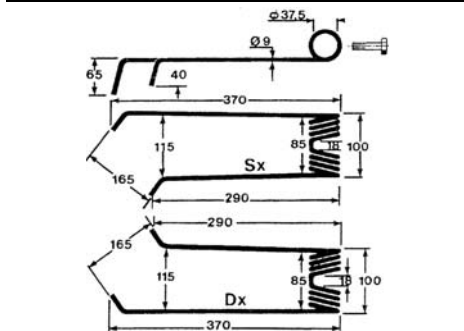

ARTICOLO	MANO	APPLICAZIONI	OEM
56911	DX	LELY Mod. Continental	41003208L
56912	SX	FRANDENT	41003208R

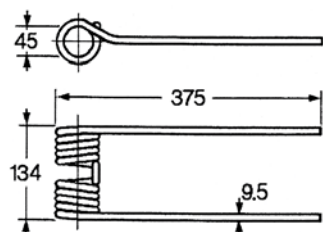

ARTICOLO	APPLICAZIONI	OEM
56913	KRONE CLAAS Volto 450H; 540H; 550H/HR, Volto 640SL; 670H, Volto 740SL; 750; 870H; 1050	9568151

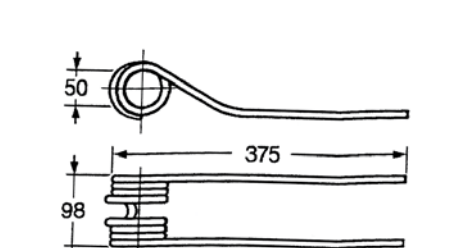

ARTICOLO	APPLICAZIONI	OEM
56914	FAHR VICON	16620057

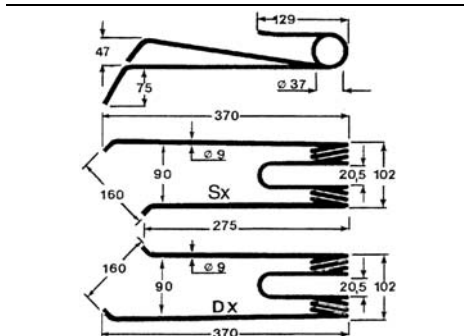

ARTICOLO	MANO	APPLICAZIONI	OEM
56915	DX	LELY	4.1017.0138.0 4.1016.0149.0
56916	SX	Mod. Lotus	4.1017.0126.0 4.1016.0159.0

segue DENTI PER GIRELLO

DENTS FANEUR - ROUND FINGERS - ZINKEN - MUELLES

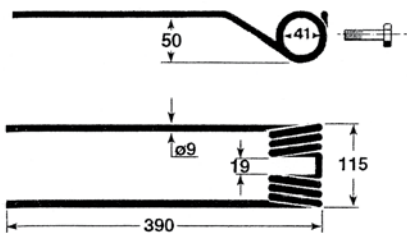

ARTICOLO	APPLICAZIONI	OEM
56917	PZ FANEX 1 SERIE	PZ 272

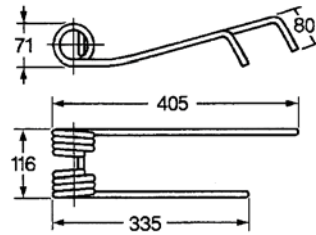

In figura è rappresentata la versione DX

ARTICOLO	MANO	APPLICAZIONI
57173	DX	GALFRÈ - Filo Ø 10 mm
57174	SX	

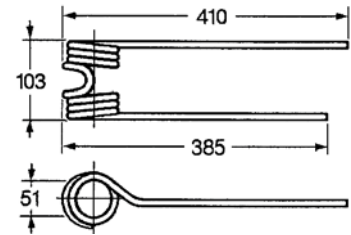

In figura è rappresentata la versione DX

ARTICOLO	MANO	APPLICAZIONI	OEM
57175	DX	PÖTTINGER	436150
57176	SX	Filo Ø 9,5 mm	436149

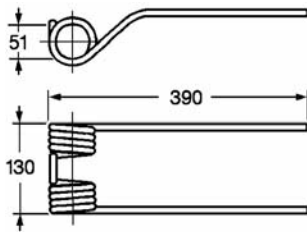

ARTICOLO	APPLICAZIONI	OEM
57472	MASCHIO Filo Ø 9,5 mm	-

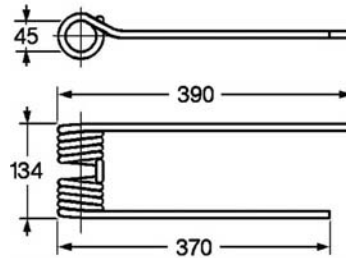

In figura è rappresentata la versione DX

ARTICOLO	MANO	APPLICAZIONI	OEM
57674	DX	KRONE	153.014.1
57675	SX	Filo Ø 9,5 mm	153.015.1

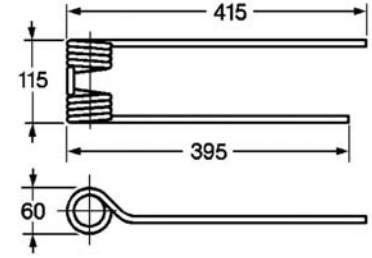

In figura è rappresentata la versione DX

ARTICOLO	MANO	APPLICAZIONI	OEM
57678	DX	FANEX	PZ 340
57679	SX	Filo Ø 9,0 mm	PZ 339

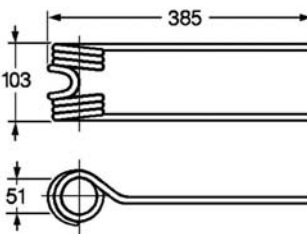

ARTICOLO	APPLICAZIONI	OEM
57680	PÖTTINGER Filo Ø 9,5 mm	436 145

DENTI PER GIROANDANATORE

DENTS GIROFANEUR - SWATH-TURNERS FINGERS - ZINKEN - MUELLES

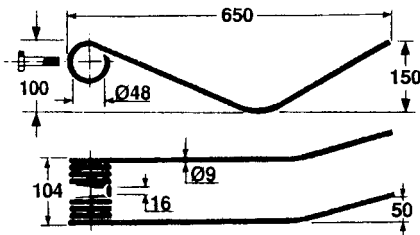

ARTICOLO	APPLICAZIONI
56365	CIMAC n°1 - GS/280 - GS/310 GHERARDI

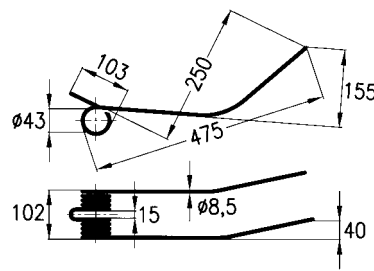

ARTICOLO	APPLICAZIONI	OEM
55877	GALFRÈ n° 1 - tipo corto KHUN n° 1 - 1ª serie (OEM: 575.020.00)	30 AN

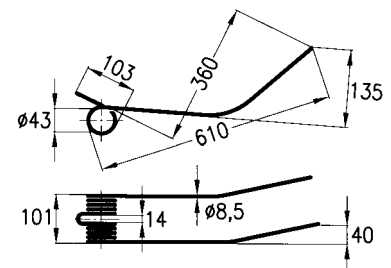

ARTICOLO	APPLICAZIONI	OEM
56412	GALFRÈ n° 2	30 AN2

segue **DENTI PER GIROANDANATORE**
DENTS GIROFANEUR - SWATH-TURNERS FINGERS - ZINKEN - MUELLES

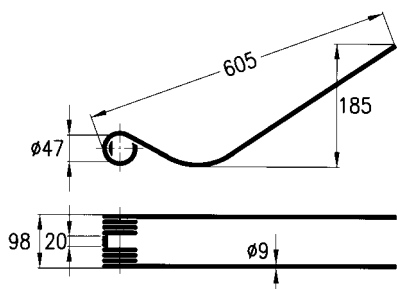

ARTICOLO	APPLICAZIONI	OEM
56417	GALFRÈ n° 4 - Filo Ø 9 mm Attacco superiore a 3 Spire	78/88

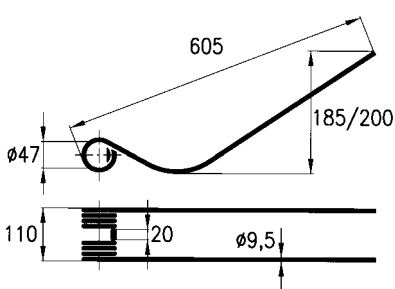

ARTICOLO	APPLICAZIONI	OEM
55646	GALFRÈ n° 5 - Filo Ø 9,5 mm Attacco inferiore a 4 Spire	

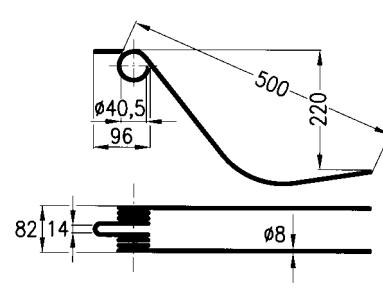

ARTICOLO	APPLICAZIONI	OEM
55640	FONTANESI n° 1 - Tipo corto ABBRIATA MARIO - IMA LARocca	

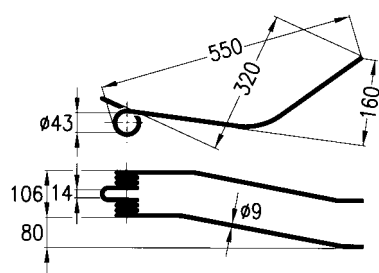

4 SPIRE

ARTICOLO	APPLICAZIONI	OEM
56256	SLAM n° 3 - WOLVO	0430

new

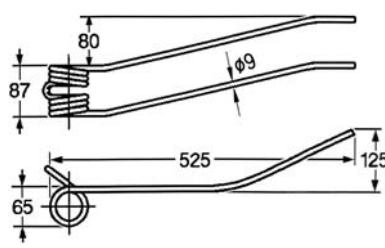

3 SPIRE

ARTICOLO	APPLICAZIONI	OEM
57647	SLAM	-

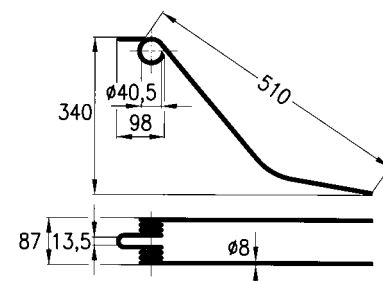

ARTICOLO	APPLICAZIONI	OEM
55666	OLIVI - MOLON ABBRIATA MARIO	

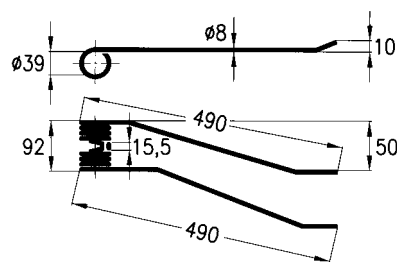

ARTICOLO	APPLICAZIONI	OEM
56418	SAMA/Mixer n° 1 - Tipo corto Giroandatore combinato	

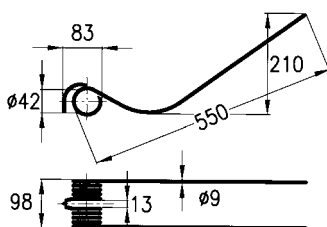

ARTICOLO	APPLICAZIONI	OEM
55878	GALFRÈ n° 3 - Mod. AG.280	78/87

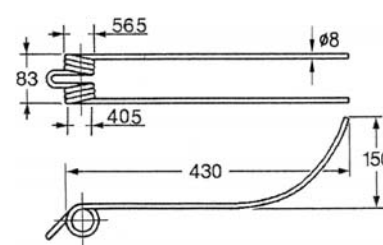

ARTICOLO	APPLICAZIONI	OEM
55672	FAHR n° 1 Mod. KS60-KS80 - VICOM	0658.0259 1.1036.630.113.00

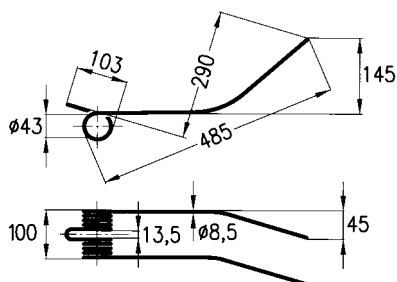

ARTICOLO	APPLICAZIONI	OEM
55671	SLAM - BORELLO GIRORAMI	

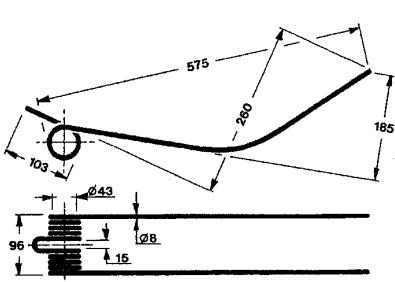

ARTICOLO	APPLICAZIONI	OEM
55662	SLAM n° 2 Tipo lungo - Mod. GR/P5 S	

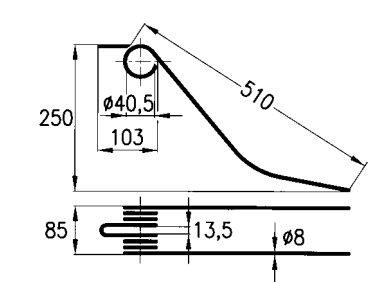

ARTICOLO	APPLICAZIONI	OEM
55645	FORT n° 1 - Tipo corto	AG 1008

segue **DENTI PER GIROANDANATORE**
DENTS GIROFANEUR - SWATH-TURNERS FINGERS - ZINKEN - MUELLES

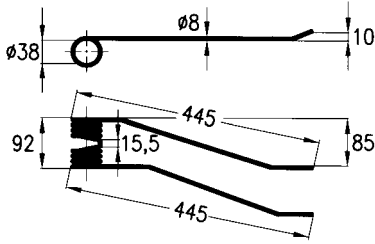

ARTICOLO	APPLICAZIONI	OEM
56414	STOLL n° 1 UM 320-321-400-410 (0.29.29.60) - N. HOLLAND 254 - FIORINI - MARANGON - FELLA Mod. TS8 1ª serie - Giro-andanatore COMBINATO a 1 o 2 giranti (490046)	0292960

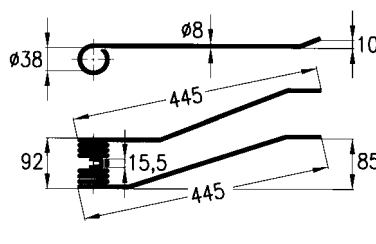

ARTICOLO	APPLICAZIONI	OEM
56415	STOLL n°1 UM320-321-400-410 (0.12.42.00) - N. HOLLAND 254 - FIORINI - MARANGON Giro-andanatore COMBINATO a 2 giranti - FELLA TS8 combinato a 2 giranti (491000)	0124200

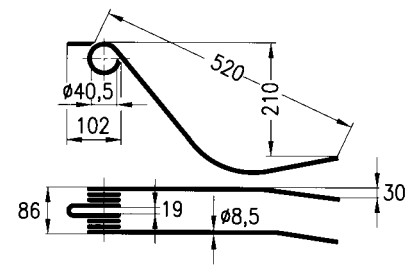

ARTICOLO	APPLICAZIONI	OEM
55673	REPOSSI n° 1 - Filo Ø 8,5 mm	TR 61

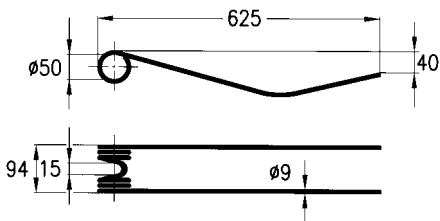

N.B.: IL DIAMETRO INTERNO del ricciolo è stato modificato da Ø 46 a Ø 50 per unificarlo alle ultime serie di giroandatori.

ARTICOLO	APPLICAZIONI	OEM
56416	REPOSSI n° 3	R 61 R 61A

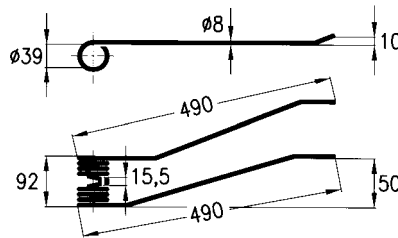

ARTICOLO	APPLICAZIONI	OEM
56419	SAMA/Mixer n° 1 - Tipo corto Giroandatore combinato	

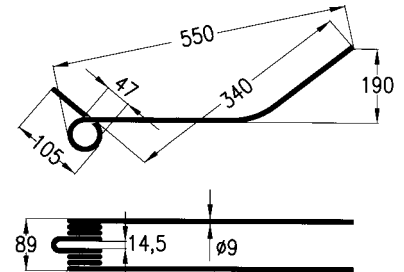

ARTICOLO	APPLICAZIONI	OEM
55664	BCS / MAINARDI n° 1 Tipo corto	8029

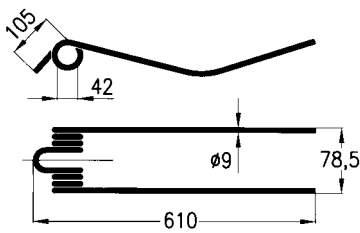

ARTICOLO	APPLICAZIONI	OEM
55668	FORT "85" 4° tipo	

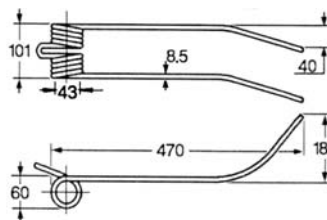

ARTICOLO	APPLICAZIONI	OEM
55670	SAMA n° 3 - Standard - FAIMA	01.342.3

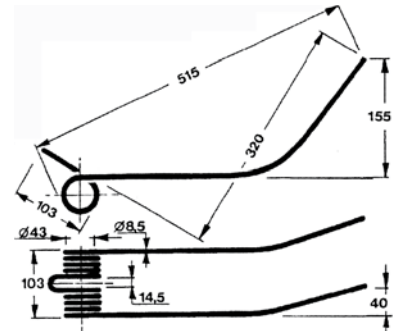

ARTICOLO	APPLICAZIONI	OEM
55634	MORRA n°1 - tipo corto dal 1986	

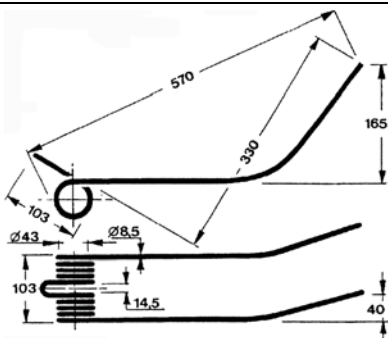

ARTICOLO	APPLICAZIONI	OEM
56635	MORRA n°2 - tipo medio dal 1987	

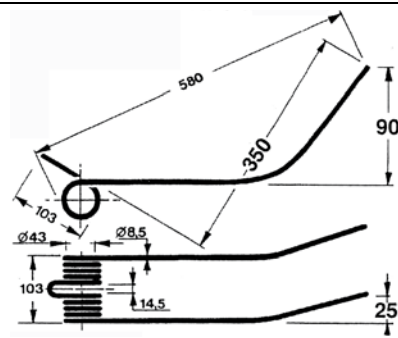

ARTICOLO	APPLICAZIONI	OEM
56636	MORRA n°3 - tipo lungo dal 1989	

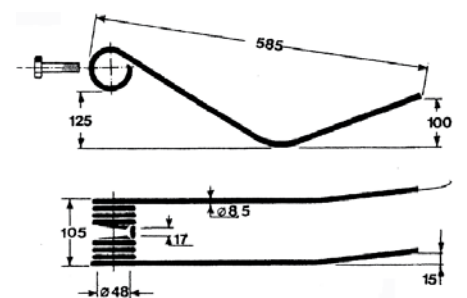

ARTICOLO	APPLICAZIONI	OEM
56637	LINCE n°1 - tipo corto	

segue **DENTI PER GIROANDANATORE**
DENTS GIROFANEUR - SWATH-TURNERS FINGERS - ZINKEN - MUELLES

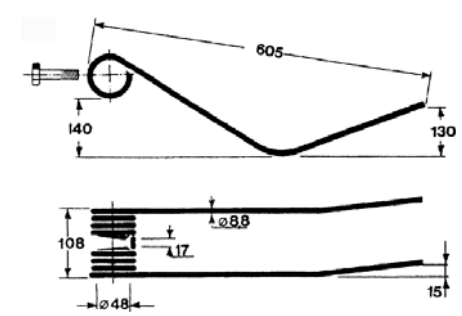

ARTICOLO	APPLICAZIONI
56638	LINCE n°2 - tipo lungo

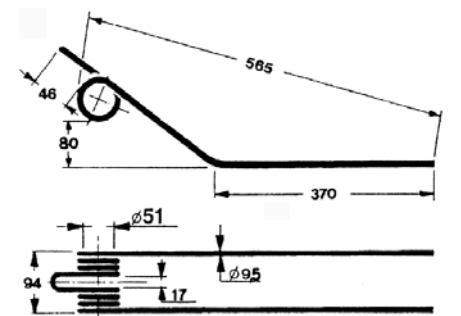

ARTICOLO	APPLICAZIONI	OEM
56639	KHUN n°3 Mod. 381 e derivati	577 20 200

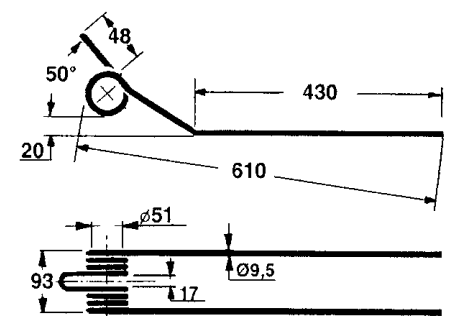

ARTICOLO	APPLICAZIONI	OEM
56640	KHUN n°5 tipo lungo Mod. GA350 - GA3501	575.625.00

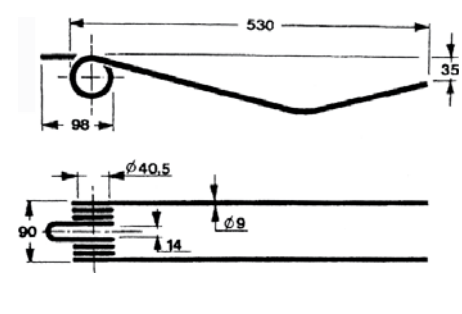

ARTICOLO	APPLICAZIONI	OEM
56641	FAHR n°2 Mod.KS83 KS85-Adattabile a PZ	1108903010100 06231509

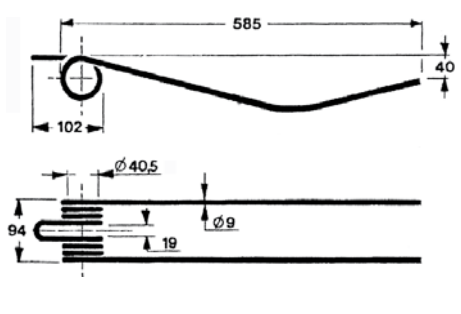

ARTICOLO	APPLICAZIONI
56642	REPOSSI n°2

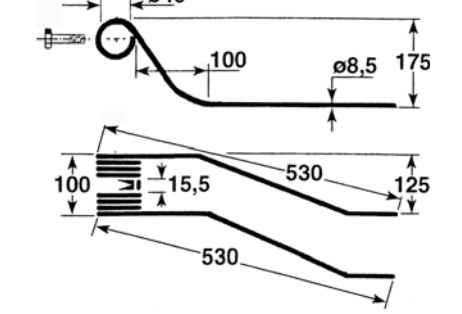

ARTICOLO	APPLICAZIONI
56643	REPOSSI n°4 /Combinato

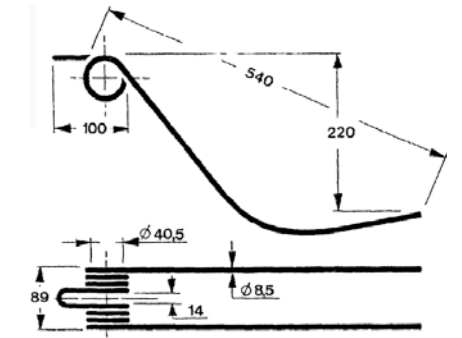

ARTICOLO	APPLICAZIONI
56644	FONTANESI n°2 tipo lungo

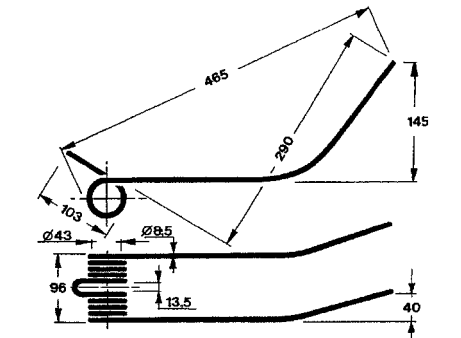

ARTICOLO	APPLICAZIONI
56645	GALFRÈ n°1 tipo corto

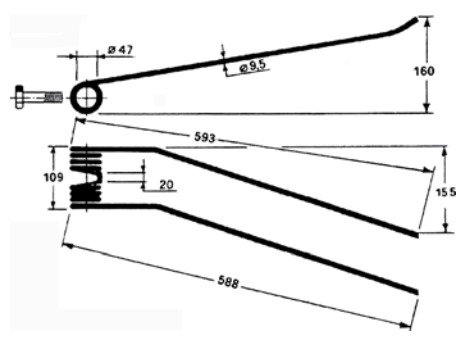

ARTICOLO	APPLICAZIONI
56646	GALFRÈ n°6 piegato

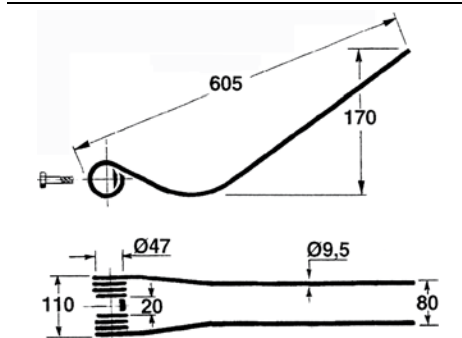

ARTICOLO	APPLICAZIONI	OEM
56647	GALFRÈ n°7 stretto Mod.280/7-280/8-320/8-350/10	78/92

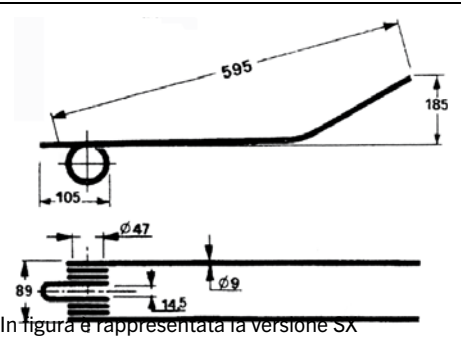

ARTICOLO	APPLICAZIONI	OEM
56648	BCS / MAINARDI n°2 lungo	8029/1

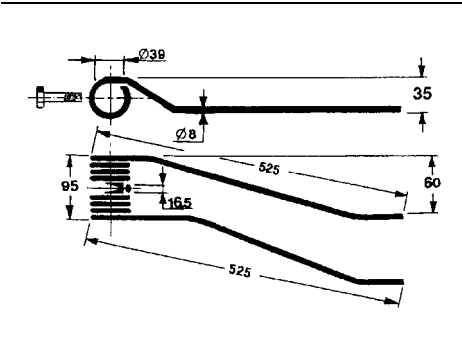

ARTICOLO	MANO	APPLICAZIONI
56649	DX	SAMA n°2 Super Mixer 2ª Serie CIMAC
56650	SX	GIROANDANATORE COMBINATO

In figura è rappresentata la versione SX

segue **DENTI PER GIROANDANATORE**
DENTS GIROFANEUR - SWATH-TURNERS FINGERS - ZINKEN - MUELLES

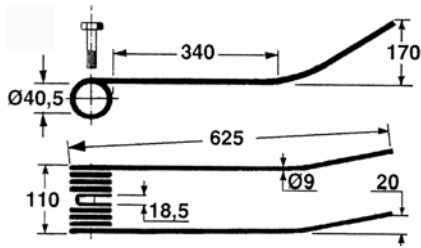

ARTICOLO	APPLICAZIONI
56651	CIMAC n°2 attacco 90°

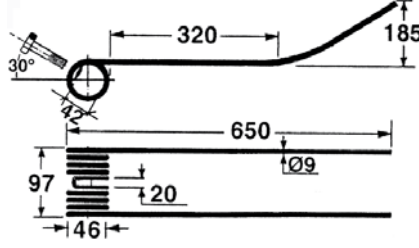

ARTICOLO	APPLICAZIONI
56652	CIMAC n°3 attacco 30° OMMA - DONDI

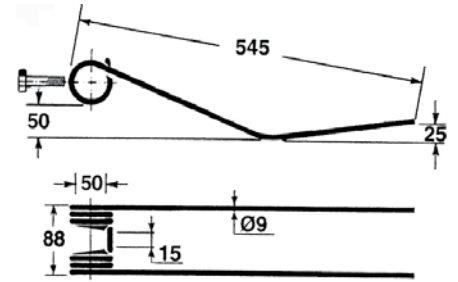

ARTICOLO	APPLICAZIONI	OEM
56653	CLAAS n°3 Mod.WS/327S -327D-330-330S	953.629.0

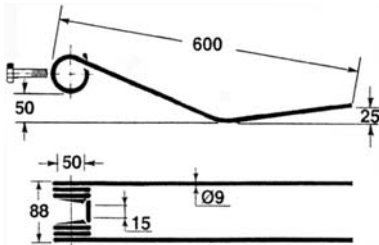

ARTICOLO	APPLICAZIONI	OEM
56654	CLAAS n°4 Liner WS 390, WS 430/470 S/T, Liner 780L/880L/1550, Liner 3000, 650 Twin, 680 Profil, 1550/1550 Twin CIMAC GS-SRT 350/11, 390/11, 420/11, 430/13, 480/13, 520/14	9554830 40GSSRT73

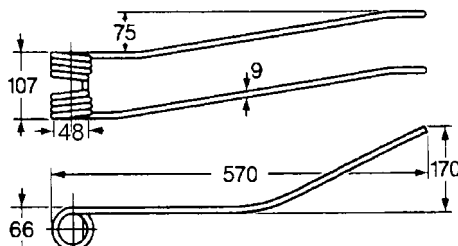

In figura è rappresentata la versione DX

ARTICOLO	MANO	APPLICAZIONI	OEM
56879	DX	FIORINI	36161090
56880	SX	FIORINI	36261090

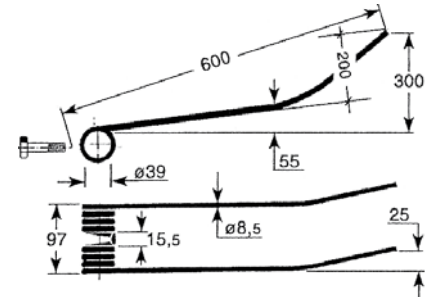

ARTICOLO	APPLICAZIONI
56918	COMAP - A.C.M.A. n°1 - FAIMA

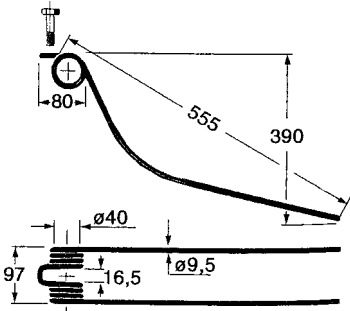

ARTICOLO	APPLICAZIONI	OEM
56919	FELLA n°4 TS425DN-TS455DN TS781-HYDRO 1600	160.111

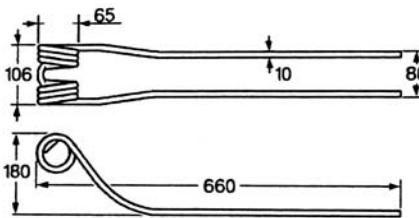

ARTICOLO	APPLICAZIONI
56920	GALFRE' n°8 Mod. Grande - Rastremato

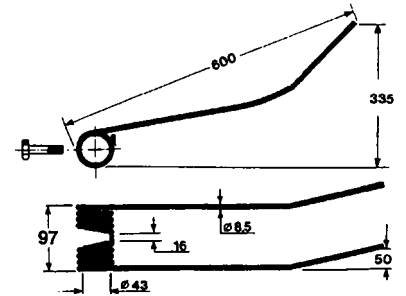

ARTICOLO	APPLICAZIONI
57256	IMA LAROCCA n°2 - ACMA n°2 - OMA - OTMA - FAIMA - GIACCAGLIA

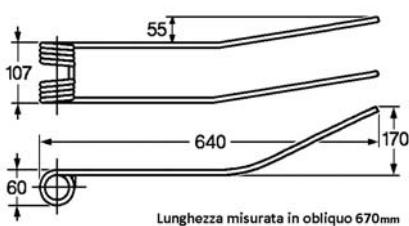

ARTICOLO	APPLICAZIONI
56921	IMA LAROCCA n°3 Tipo Lungo - Mod. DP4 Diritto

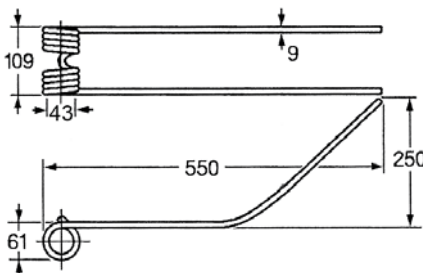

ARTICOLO	APPLICAZIONI
57324	SAMA - ABA GROUP - ANGELONI

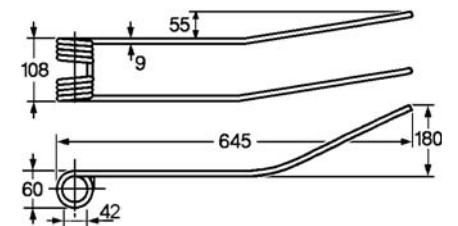

ARTICOLO	APPLICAZIONI
57325	IMA LAROCCA - SICMA Mod. GA 280/320 (dal 2008)

segue **DENTI PER GIROANDANATORE**
DENTS GIROFANEUR - SWATH-TURNERS FINGERS - ZINKEN - MUELLES

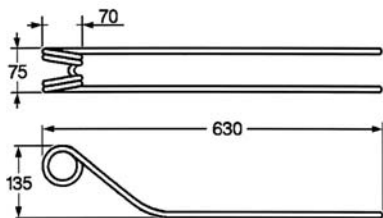

ARTICOLO	APPLICAZIONI
57435	KRONE

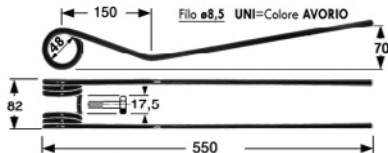

ARTICOLO	APPLICAZIONI	OEM
57436	PÖTTINGER TOP - EUROTOP	436.033

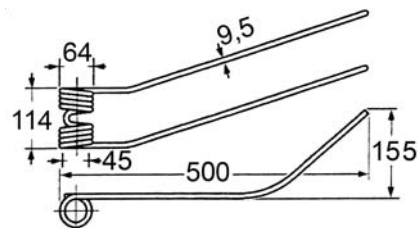

ARTICOLO	APPLICAZIONI
57445	F.C.R. Girorami Filo ø 9,5 mm

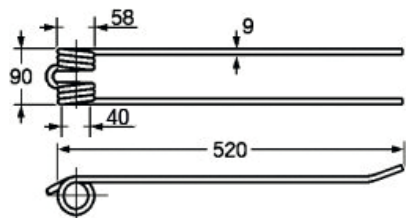

ARTICOLO	APPLICAZIONI	OEM
57446	STOLL R285DS- R315DS-R355DS-R370-R385DS-R415DS-R420-R460-655DS-R655AS-R780Hydro- R1400-R1405-R1425 Filo ø 9,0	0621811 0699780

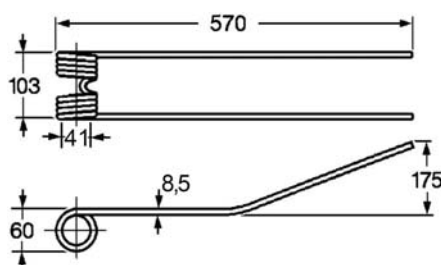

ARTICOLO	APPLICAZIONI	OEM
57476	CORMA Filo ø 8,5 mm	-

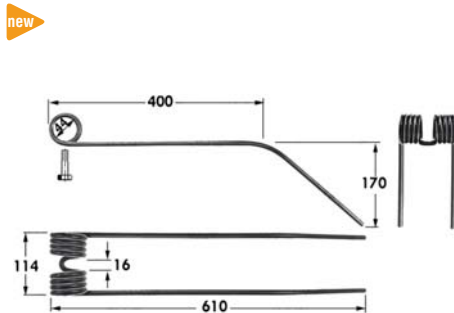

ARTICOLO	APPLICAZIONI	OEM
57620	F.C.R. Filo ø 9,5 mm	-

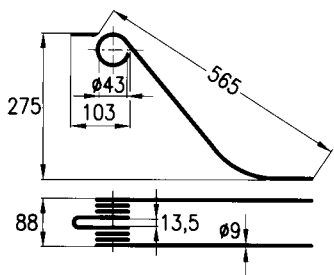

ARTICOLO	APPLICAZIONI	OEM
55876	FORT n° 2 - Tipo lungo Mod. 280 - GA300 - GA301	8010

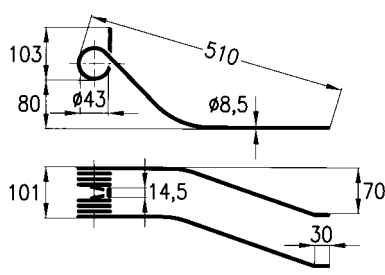

ARTICOLO	APPLICAZIONI	OEM
56413	KHUN n° 2 - Tipo lungo Mod. 280 - GA300 - GA301	10.1142 57502000 57701700

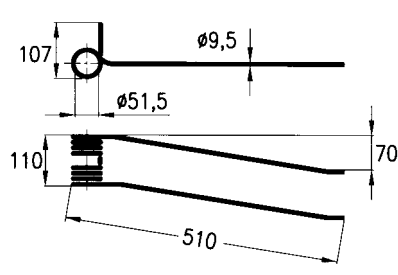

ARTICOLO	APPLICAZIONI	OEM
55879	KHUN n° 4 Mod. GRS 25N e Derivati	576.440.10

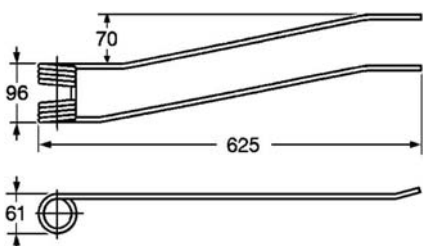

In figura è rappresentata la versione DX

ARTICOLO	MANO	APPLICAZIONI	OEM
57681	DX	BORELLO tipo Lungo	-
57682	SX	Filo ø 8,5 mm	-

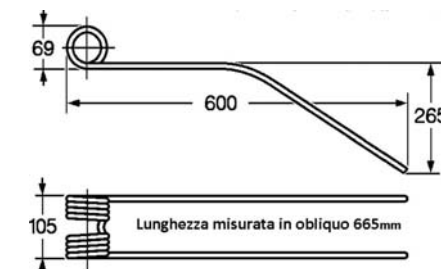

ARTICOLO	APPLICAZIONI	OEM
57683	CIMAC - FERABOLI Filo ø 9,0 mm	18G0014

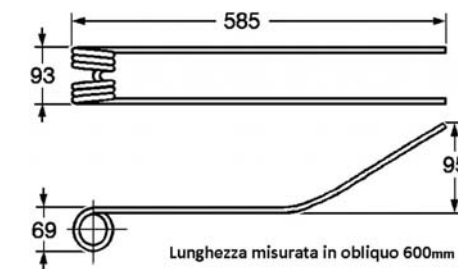

ARTICOLO	APPLICAZIONI	OEM
57684	FAHR Filo ø 9,0 mm	1660.6394

segue **DENTI PER GIROANDANATORE**
DENTS GIROFANEUR - SWATH-TURNERS FINGERS - ZINKEN - MUELLES

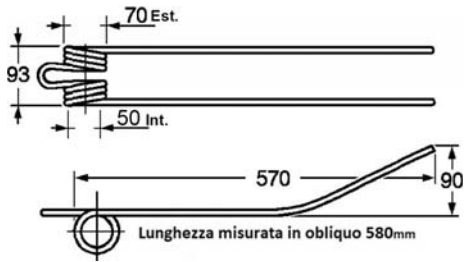

ARTICOLO	APPLICAZIONI	OEM
57685	MASCHIO GOLIA - DA ROS Filo Ø 9,0 mm	EDA000002R - 6900330

DENTI ANDANATORE

RESSORTS POUR ANDAINAGE - HAY-RAKE SPRINGS - FEDERZINKEN - MUELLES PARA HILERADOR

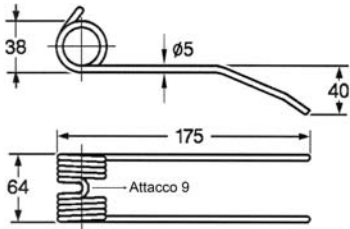

ARTICOLO	APPLICAZIONI	OEM
57427	ROC	-

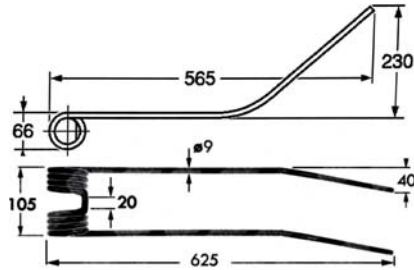

ARTICOLO	APPLICAZIONI	OEM
57473	ENOROSI RR320, RR350 SIGMA 4 ALPHA SPEED 320, 350	11010521

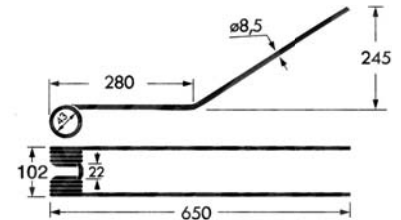

ARTICOLO	APPLICAZIONI	OEM
57475	GIACCAGLIA GRS 288, 329	-

DENTI VOLTAFIENO

DENTS POUR FANEUSE - SWATH-TURNERS FINGERS - ZINKEN HEUWENDER - MUELLES HENIFICADORAS DE HENO

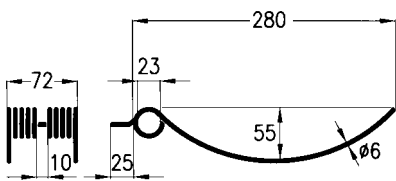

ARTICOLO	APPLICAZIONI
55679	BCS

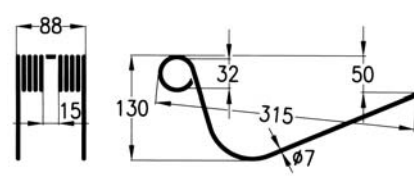

ARTICOLO	APPLICAZIONI
56420	LINCE - Adattabile a diverse marche

DENTI PER RANGHINATORI STELLARI

RESSORTS POUR RATEAUX-ANDAINEURS ÉTOILE - STELLAR RAKES SPRINGS - ZINKEN FÜR STERN-RECHWENDER - MUELLES PARA RASTRILLOS HILERADÓRES ESTELAR

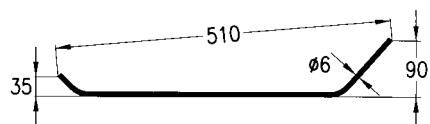

ARTICOLO	APPLICAZIONI	OEM
55693	ORIONE	290422E

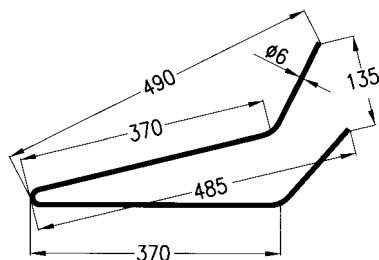

ARTICOLO	APPLICAZIONI	OEM
56421	HEUMA interno / NIEMEYER	1138

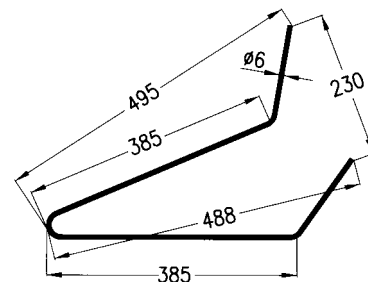

ARTICOLO	APPLICAZIONI	OEM
56422	HEUMA esterno NIEMEYER	1139

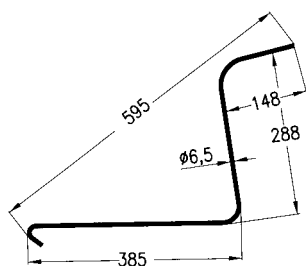

ARTICOLO	APPLICAZIONI	OEM
55682	JOHN DEERE - ABBRIATI - ROSSI - IMA LAROCCA - CICORIA	J.D. VL2326

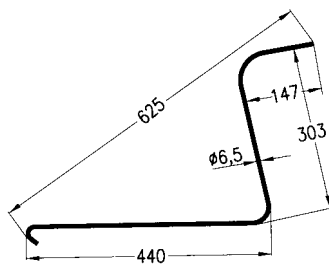

ARTICOLO	APPLICAZIONI	OEM LELLY
55680	LELY / VICON lunga - TONUTTI / MORRA	92611 90092611

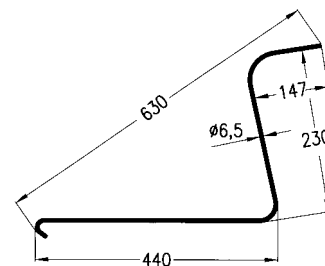

ARTICOLO	APPLICAZIONI	OEM
55885	LELY - VICON lunga Braccio corto	33316

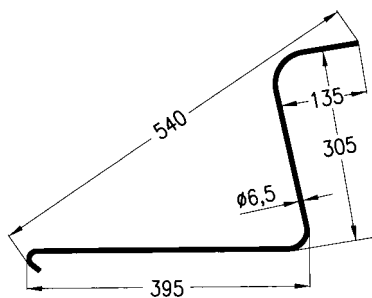

ARTICOLO	APPLICAZIONI	OEM
55691	LELY - VICON corta	

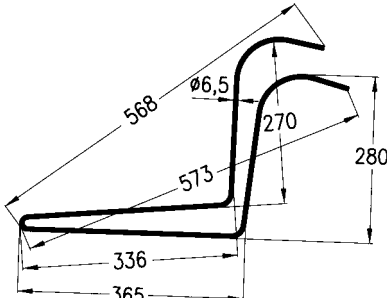

ARTICOLO	APPLICAZIONI	OEM
55882	BAUTZ interno corto portato	SP 04.02

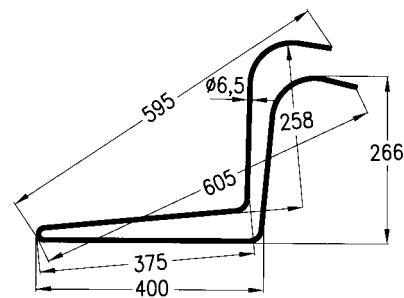

ARTICOLO	APPLICAZIONI	OEM
55883	BAUTZ esterno lungo portato	SP 04.03

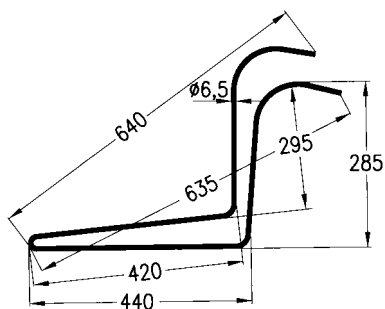

ARTICOLO	APPLICAZIONI	OEM
56548	CICORIA lunga esterna 2ª serie	

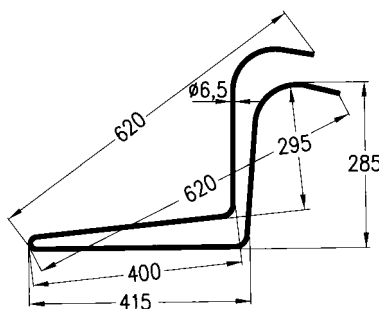

ARTICOLO	APPLICAZIONI	OEM
56424	CICORIA corta interna 2ª serie	

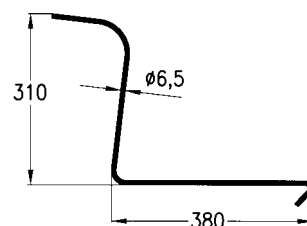

ARTICOLO	APPLICAZIONI	OEM
56423	ABBRIATA	

segue DENTI PER RANGHINATORI STELLARI

RESSORTS POUR RATEAUX-ANDAINEURS ÉTOILE - STELLAR RAKES SPRINGS - ZINKEN FÜR STERN-RECHWENDER - MUELLES PARA RASTRILLOS HILERADÓRES ESTELAR

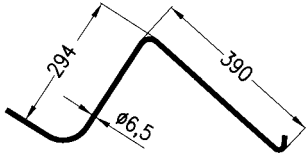

ARTICOLO	APPLICAZIONI
55884	JOHN DEERE REMY - ROSSI

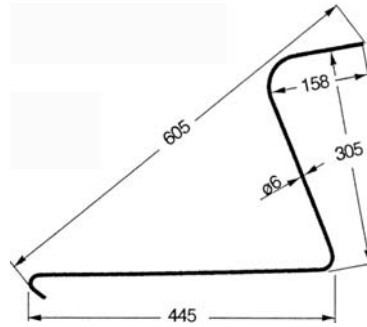

ARTICOLO	APPLICAZIONI
56655	LELY Lunga

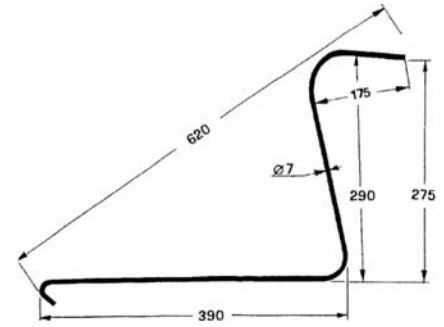

ARTICOLO	APPLICAZIONI
56656	OTMA-OMA/italia-OMMA-SAMA SITREX - FAZA

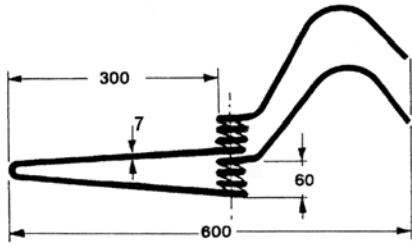

ARTICOLO	APPLICAZIONI
56657	TONUTTI corto per modelli PORTATI

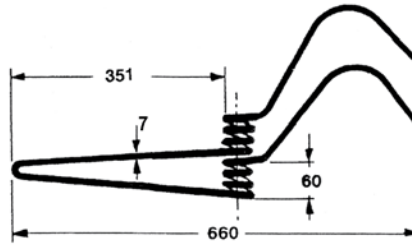

ARTICOLO	APPLICAZIONI
56658	TONUTTI lungo per modelli TRAINATI

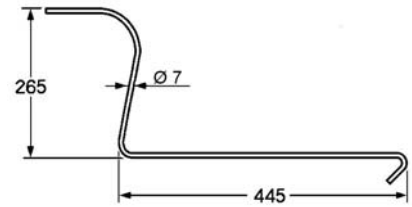

ARTICOLO	APPLICAZIONI
57391	TONUTTI ENOROSSO

DENTI PER RANGHINATORI A CINGHIA/CATENA

RESSORTS POUR RATEAUX-ANDAINEURS - RAKES SPRINGS - ZINKEN FÜR RECHWENDER - MUELLES PARA RASTRILLOS HILERADORES

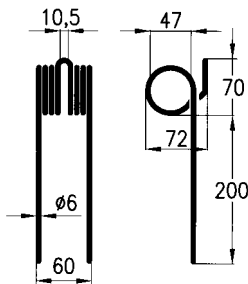

ARTICOLO	APPLICAZIONI	OEM
55546	GASPARDO G.210	ZC 708 R01561

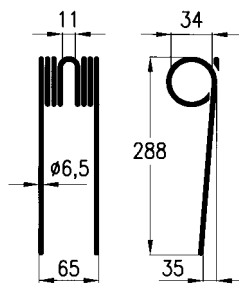

ARTICOLO	APPLICAZIONI
56425	MOLON tipo nuovo

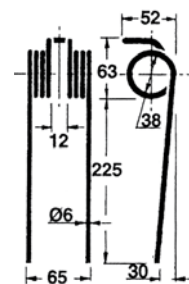

ARTICOLO	APPLICAZIONI
56659	MOLON tipo vecchio

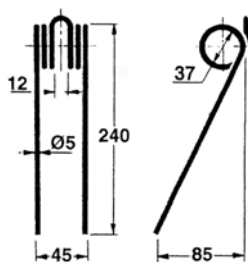

ARTICOLO	APPLICAZIONI
56660	MOLON leggero - B.C.S. leggero

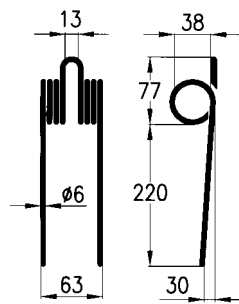

ARTICOLO	APPLICAZIONI	OEM
55555	CECCATO	C 063/A

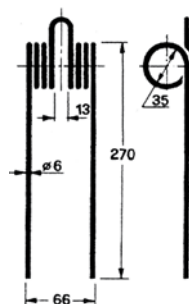

ARTICOLO	APPLICAZIONI	OEM
56661	PZ/9	1.32.00

DENTI PER RANGHINATORI A CINGHIA/CATENA

RESSORTS POUR RATEAUX-ANDAINEURS - RAKES SPRINGS - ZINKEN FÜR RECHWENDER - MUELLES PARA RASTRILLOS HILERADORES

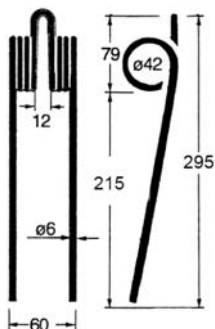

new

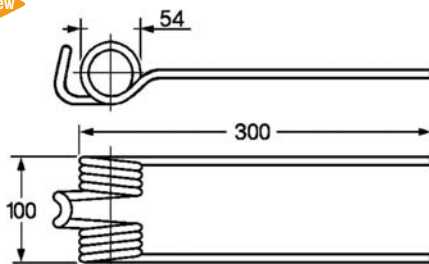

ARTICOLO	APPLICAZIONI
56662	DA ROS

ARTICOLO	APPLICAZIONI
57686	BICIEFFE PIEGATO - SPANDIPAGLIA BRAVO Filo Ø 8,0 mm

DENTI RASTRELLIERA GIROANDANATORE

DENTS RAYONNAGE GIROFANEURS - SWATH-TURNERS FINGERS - ZINKEN BRETT - MUELLES RASTRILLOS

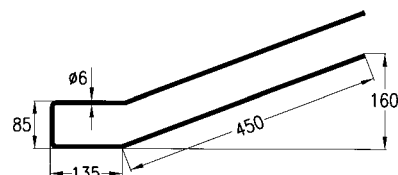
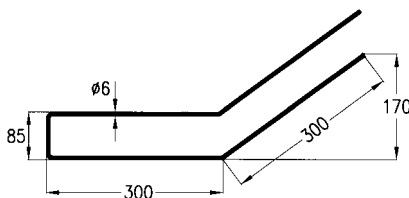
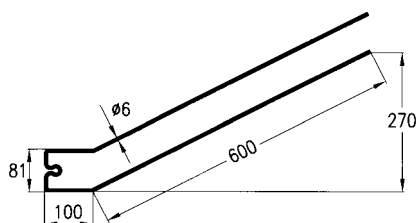

ARTICOLO	APPLICAZIONI	OEM
56426	GALFRÈ standard	49

ARTICOLO	APPLICAZIONI
56427	FORT piega corta - FONTANESI - SLAM - KUHN

ARTICOLO	APPLICAZIONI
56428	FORT piega lunga - FONTANESI - SLAM

new

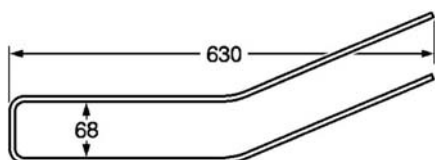

new

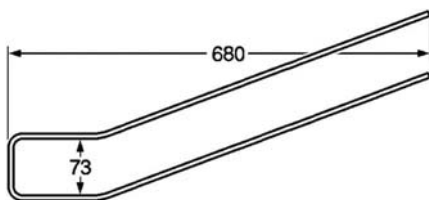

ARTICOLO	APPLICAZIONI
57690	CORMA - CIMAC - DONDI - GHERARDI Filo Ø 6,0 mm

ARTICOLO	APPLICAZIONI
57691	I.M.A. LA ROCCA Filo Ø 6,0 mm

DENTI AUTOCARICANTE RACCOLITORE

DENTS AUTOCHARGEURS RAMASSEUSE - SELF-LOADERS FINGERS - ZINKEN SELBSBELADUNG RODER - MUELLES COSECHADORA

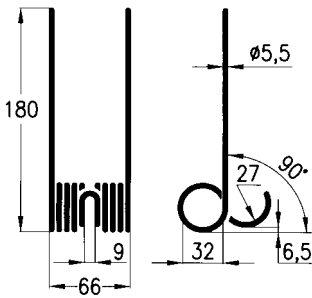

ARTICOLO	APPLICAZIONI
55584	BERNI EUROPA tipo vecchio

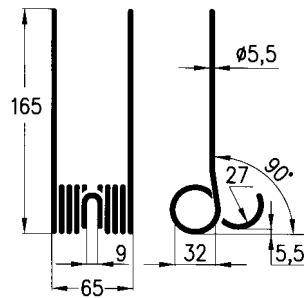

ARTICOLO	APPLICAZIONI	OEM
56241	BERNI EUROPA tipo vecchio - 2ª vers.	361610

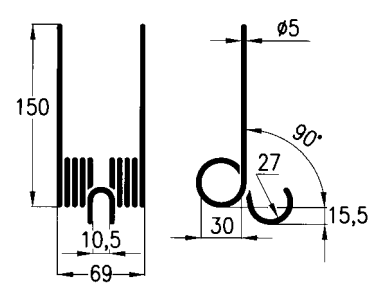

ARTICOLO	APPLICAZIONI
56429	D.B.D. stretta - FORT - CARBONI - SANTINI - GHIOZZI - MERLINI - I.R.A. - SCALVENZI - OMAS - MARANGON

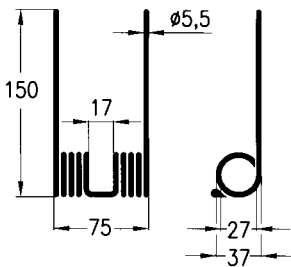

ARTICOLO	APPLICAZIONI	OEM
55587	GALLIGNANI - KEMPER - MIPRA KRONE 1ª serie	2.420.05

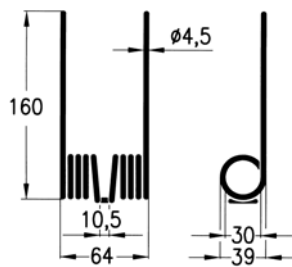

ARTICOLO	APPLICAZIONI
55586	BOSCO ATTILIO tipo standard

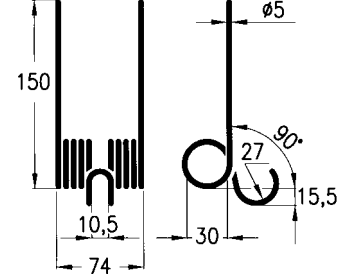

ARTICOLO	APPLICAZIONI
55583	D.B.D. stretta - FORT - CARBONI - SANTINI - GHIOZZI - MERLINI - I.R.A. - SCALVENZI - OMAS - MARANGON

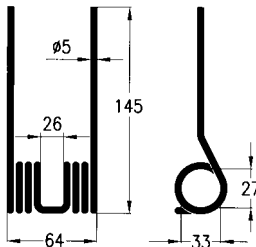

ARTICOLO	APPLICAZIONI	OEM
55588	MENGELE Mod. LW157 - LAW350	03020350

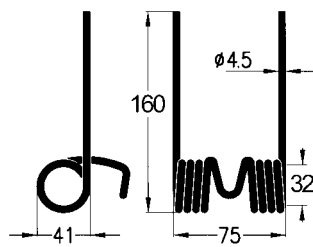

ARTICOLO	APPLICAZIONI
56430	ITALO SVIZZERA

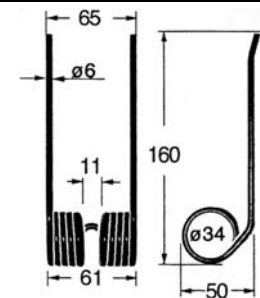

ARTICOLO	APPLICAZIONI	OEM
56663	STEYR	8040.219.052

new

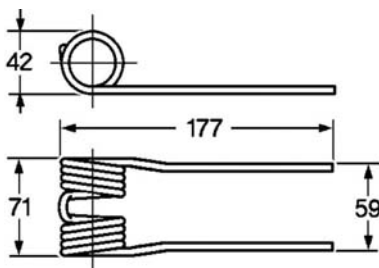

ARTICOLO	APPLICAZIONI	OEM
57687	KRONE Filo Ø 6,0 mm	270098361

new

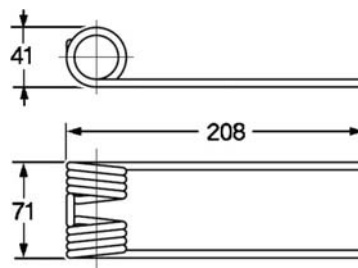

ARTICOLO	APPLICAZIONI	OEM
57688	LELY - WELGER Filo Ø 5,5 mm	0940527000

new

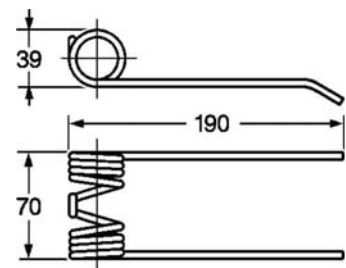

ARTICOLO	APPLICAZIONI	OEM
57689	WELGER MASTER NUOVO MOD. Filo Ø 5,0 mm	-

DENTI PER FALCIACONDIZIONATRICI

DENTS POUR FAUCHEUSES-CONDITIONNEUSES-ANDAINÉUSES - SPRINGS FOR MOWER-CONDITIONERS
ZINKEN FÜR MAEHER MIT KNICK ODER QUESTCHEINRICHTUNG - MUELLES PARA SEGADORAS-ACONDICIONADORAS-HILERADORAS

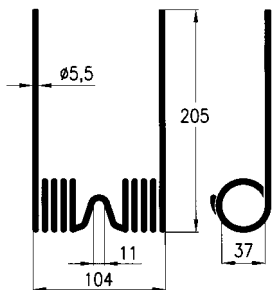

ARTICOLO	APPLICAZIONI	OEM
55863	HESSTON - Mod. PT7 - 1007 - 1010 - 1070 - 1110 - 1120	750075

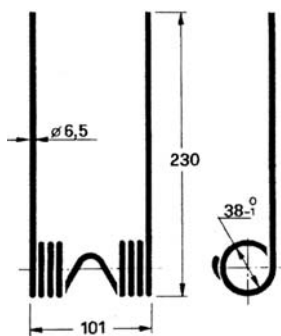

ARTICOLO	APPLICAZIONI	OEM
56664	JOHN DEERE n°1	

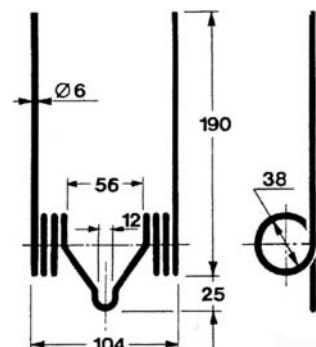

ARTICOLO	APPLICAZIONI	OEM
56665	JOHN DEERE n°2	E 37596

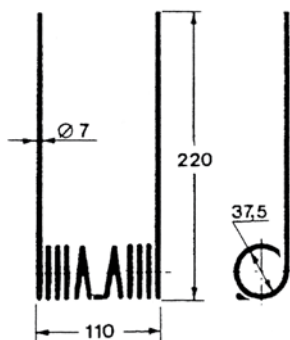

ARTICOLO	APPLICAZIONI	OEM
56666	LAVERDA	33030

DENTI PER RANGHINATORI A PETTINE

DENTS POUR RATEAUX-ANDAINEURS - SPRINGS FOR SIDE DELIVERY RAKES - ZINKEN FÜR RECHWENDER - MUELLES PARA RASTRILLOS HILERADORES

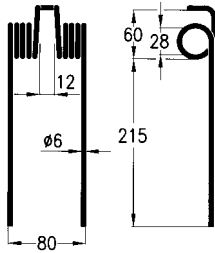

ARTICOLO	APPLICAZIONI	OEM
55532	FONTANESI Forma tipo McCORMICK	FF34

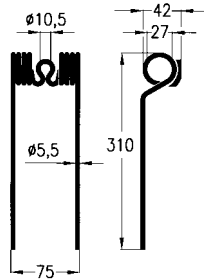

ARTICOLO	APPLICAZIONI	OEM
55533	FONTANESI foro \varnothing 10,5 mm Forma tipo BCS	FF8911

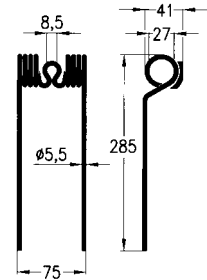

ARTICOLO	APPLICAZIONI	OEM
55522	BCS attacco \varnothing 8,6 mm FORT/F3 - BIANCHI - ITALO SVIZZERA	BCS 00311

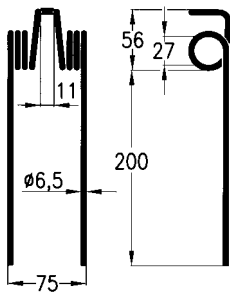

ARTICOLO	APPLICAZIONI
55558	LINCE Super

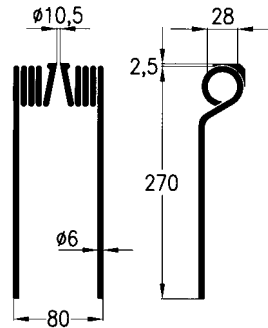

ARTICOLO	APPLICAZIONI
55559	LINCE T.A.

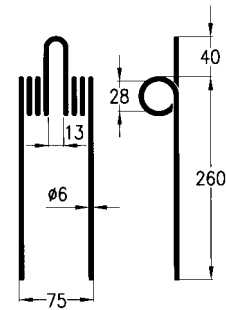

ARTICOLO	APPLICAZIONI	OEM
55542	FORT F2	F2/67

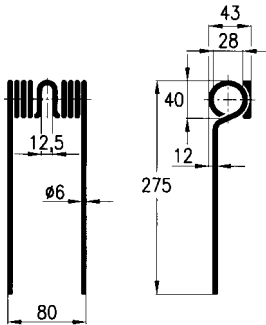

ARTICOLO	APPLICAZIONI	OEM
56432	REPOSSI n° 1	D0011/A

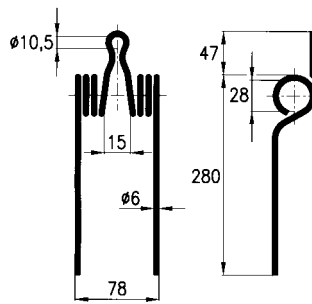

ARTICOLO	APPLICAZIONI
55560	CANTONE/MAB 4

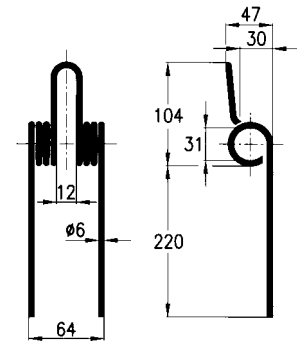

ARTICOLO	APPLICAZIONI
55554	CANTONE/R3D tipo vecchio

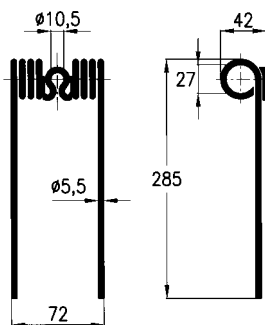

ARTICOLO	APPLICAZIONI
55531	SLAM/Colibrì - OMA - BCS - FORT

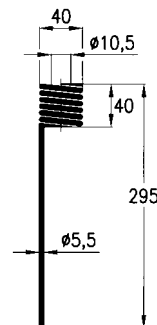

ARTICOLO	APPLICAZIONI
55548	OLIVI

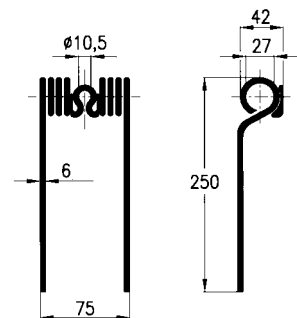

ARTICOLO	APPLICAZIONI
55552	IMA LAROCCA T/Corto adattabile a: GIORGI - SAMA

segue DENTI PER RANGHINATORI A PETTINE

DENTS POUR RATEAUX-ANDAINEURS - SPRINGS FOR SIDE DELIVERY RAKES - ZINKEN FÜR RECHWENDER - MUELLES PARA RASTRILLOS HILERADORES

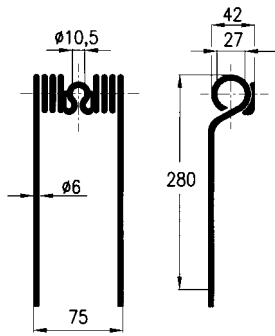

ARTICOLO	APPLICAZIONI	OEM
55553	IMA LAROCCA T/Lungo adattabile a: GIORGI - BCS	BCS 311/10

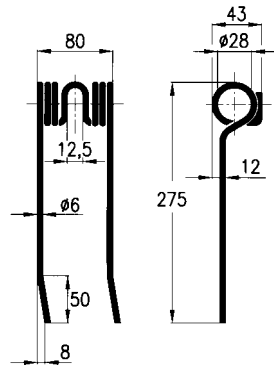

ARTICOLO	APPLICAZIONI
55562	REPOSSI n° 2 punte piegate

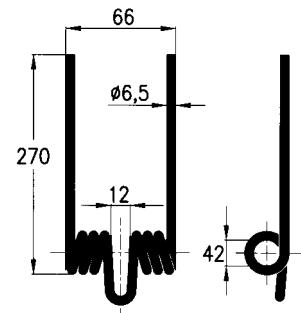

ARTICOLO	APPLICAZIONI
56433	BITTANTE MARIO

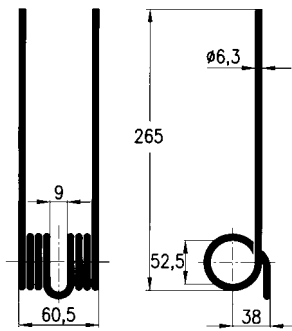

ARTICOLO	APPLICAZIONI	OEM
56434	JF - GASPARDO	14.330.397

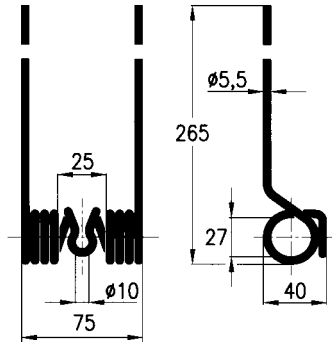

ARTICOLO	APPLICAZIONI
55550	SANTINI

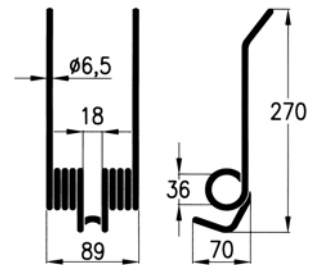

ARTICOLO	APPLICAZIONI
55561	FONTANI Rap. 3 Bietole

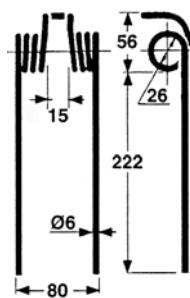

ARTICOLO	APPLICAZIONI	OEM
56667	Mc CORMICK	13553GA

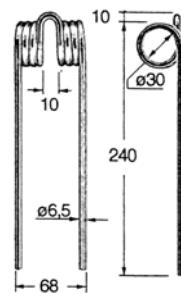

ARTICOLO	APPLICAZIONI	OEM
56668	LAVERDA Corto	62070

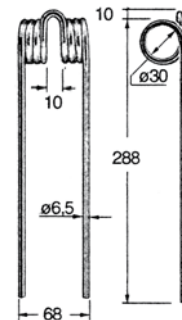

ARTICOLO	APPLICAZIONI	OEM
56669	LAVERDA Lungo	62071

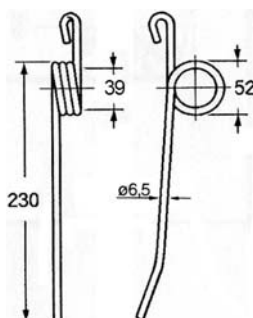

ARTICOLO	APPLICAZIONI
57136	SGORBATI

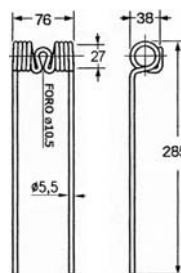

ARTICOLO	APPLICAZIONI
57135	FONTANESI - BCS

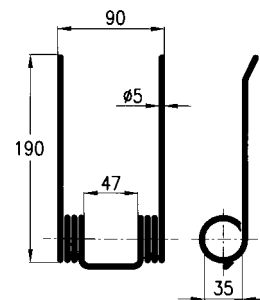

ARTICOLO	APPLICAZIONI	OEM
55572	AMA larga - Tutti i modelli dal 1962 al 1980	L75-311

DENTI PER PRESSA RACCOLTRICE

DENTS POUR PRESSE-RAMASSEUSE - SELF-LOADERS FINGERS - ZINKEN FÜR PRESSE-ZUSAMMENTRAG - MUELLES PARA PRENSA-COSECHADORAS

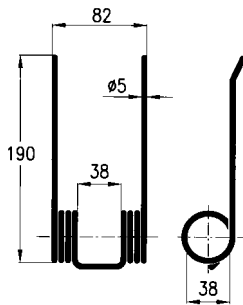

ARTICOLO	APPLICAZIONI	OEM
55575	AMA stretta - Tutti i modelli dal 1980 al 1982 Mod. 263-283	1102-001

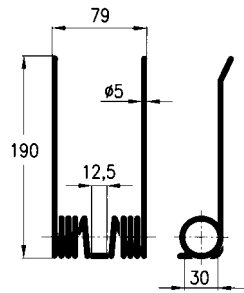

ARTICOLO	APPLICAZIONI	OEM
55576	AMA attacco angolare - Tutti i modelli dal 1982 al 1991	902-402

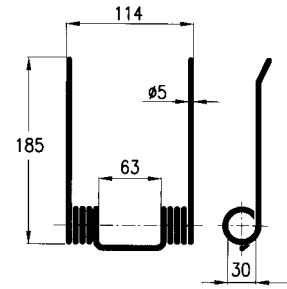

ARTICOLO	APPLICAZIONI	OEM
56442	SGORBATI larga - Mod. 68-69 NEW HOLLAND - Mod. 67-68-69	SG.=37762 N.H.=127566

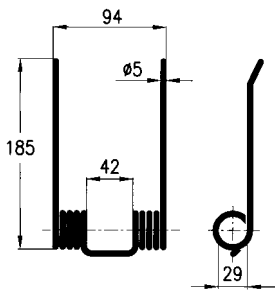

ARTICOLO	APPLICAZIONI	OEM
55590	SGORBATI media - Mod. 169-171 - NEW HOLLAND media	SG.=37762/1 N.H.=53225

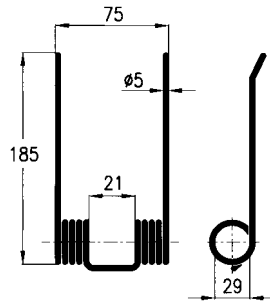

ARTICOLO	APPLICAZIONI	OEM
56443	SGORBATI media Mod. 181	700.320

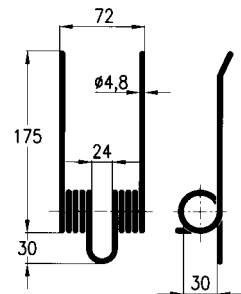

ARTICOLO	APPLICAZIONI	OEM
55591	SGORBATI Mod. 133-134-138-233-238 Rotopresse: Serie 800	1111/6401

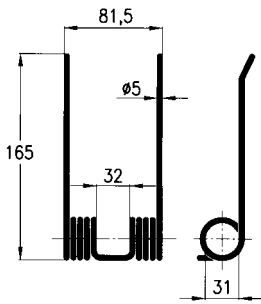

ARTICOLO	APPLICAZIONI	OEM
56444	SGORBATI Att. Angol. - Mod. 130-131-230 Rotopresse: Serie 300	1116/00159

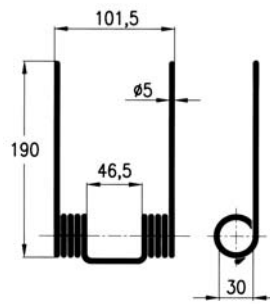

ARTICOLO	APPLICAZIONI	OEM
55594	GALLIGNANI larga - Tutti i modelli dal 1958 al 1972 (A fascia larga)	88.76.210

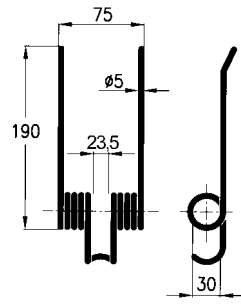

ARTICOLO	APPLICAZIONI	OEM
55597	GALLIGNANI stretta Tutti i modelli dal 1973	88.76.278

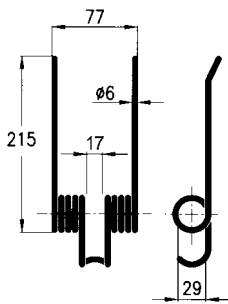

ARTICOLO	APPLICAZIONI	OEM
55860	GALLIGNANI presse: 5190 - 6190 - 7190 - 8000 - 8100 - 8190 - 7100 Rotopresse 9200S - 9500S	88.76.415

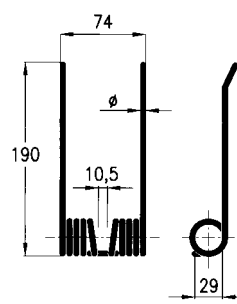

ARTICOLO	APPLICAZIONI	Ø FILO	OEM
55581	WELGER larga - Std per tutti i modelli di presse e rotopresse	5	0343-12 0343-17
56811		5,5 (rinforzato)	0940.52.21.00

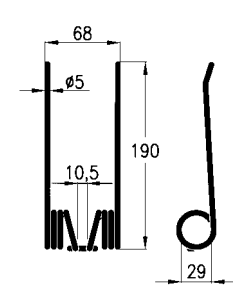

ARTICOLO	APPLICAZIONI	OEM
56445	WELGER stretta standard per tutti i modelli di presse e rotopresse	0.343.51 0940.52.25.00

segue DENTI PER PRESSA RACCOLTRICE

DENTS POUR PRESSE-RAMASSEUSE - SELF-LOADERS FINGERS - ZINKEN FÜR PRESSE-ZUSAMMENTRAG - MUELLES PARA PRENSA-COSECHADORAS

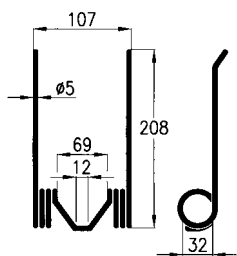

ARTICOLO	APPLICAZIONI	OEM
55600	JOHN DEERE Mod. 224	E17615 DC17883

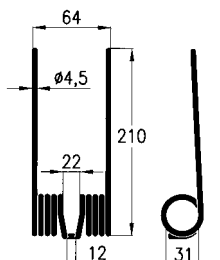

ARTICOLO	APPLICAZIONI	OEM
55602	JOHN DEERE Mod. 332 - 336 - 342 - 346	E41833

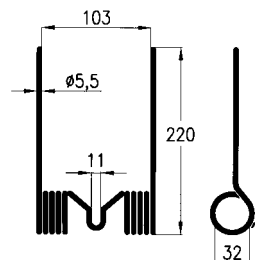

ARTICOLO	APPLICAZIONI	OEM
56395	M. FERGUSON larga Mod. 10/8 - 15/8 - 20/8	152.212M1 781.943M1

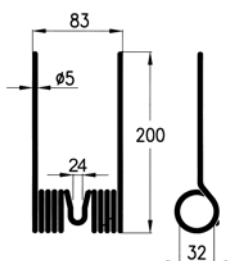

ARTICOLO	APPLICAZIONI	OEM
56396	M. FERGUSON stretta Mod. 120 - 124 - 128 LANDINI Mod. 1500	585.136M1

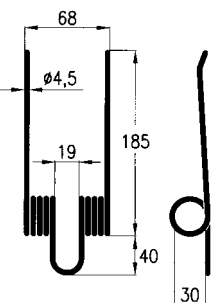

ARTICOLO	APPLICAZIONI	OEM
55867	NEW HOLLAND Mod. 265 - 270 - 271 - 366	161.367

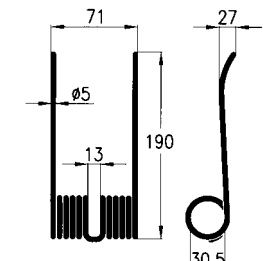

ARTICOLO	APPLICAZIONI	OEM
55866	NEW HOLLAND Mod. 276 - 370 - 376 - 377 - 920 - 930 - 935 - 940 presse e rotopresse	131.673

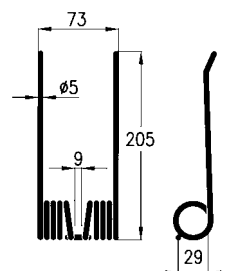

ARTICOLO	APPLICAZIONI	OEM
56446	CLAAS Markant 40 - 50 - 55 - 60	807.297

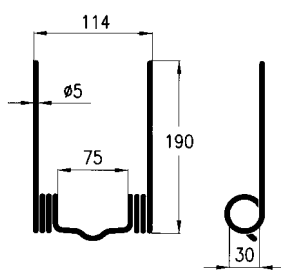

ARTICOLO	APPLICAZIONI	OEM
56397	CASE F.200 - 220 M. FERGUSON 105	F60546

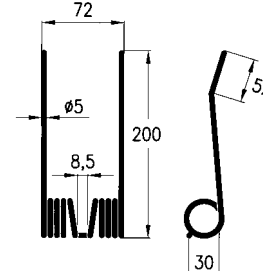

ARTICOLO	APPLICAZIONI	OEM
56447	FAHR - KÖLA presse e rotopresse 1ª serie	1.2010.130.139.00 658.1781

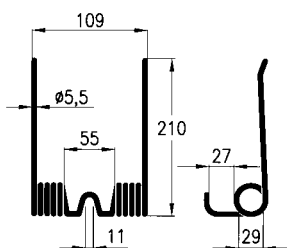

ARTICOLO	APPLICAZIONI	OEM
55589	ITALO-SVIZZERA tipo larga	

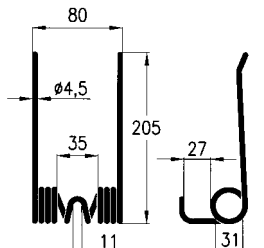

ARTICOLO	APPLICAZIONI	OEM
55694	I. SVIZZERA stretta - Tutti i mod. prod. dal 1978 al 1986 - ABBRIATA - Tutti i mod. dal 1978 al 1986	PR 1820 7111820

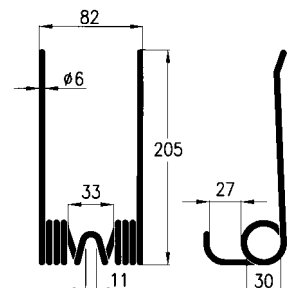

ARTICOLO	APPLICAZIONI	OEM
56448	ABBRIATA - Tipo nuovo - Tutti i modelli dal 1987 in poi	D0149

segue DENTI PER PRESSA RACCOLTRICE

DENTS POUR PRESSE-RAMASSEUSE - SELF-LOADERS FINGERS - ZINKEN FÜR PRESSE-ZUSAMMENTRAG - MUELLES PARA PRENSA-COSECHADORAS

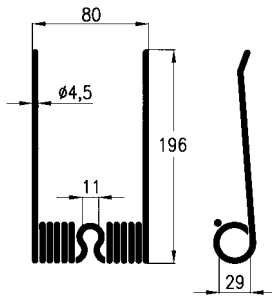

ARTICOLO	APPLICAZIONI	OEM
55615	ABBRIATA - Tipo vecchio - Tutti i modelli dal 1962 al 1977	D0098

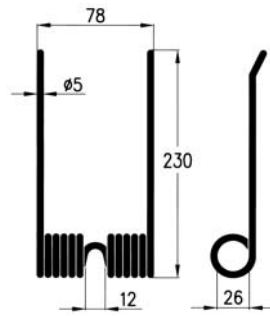

ARTICOLO	APPLICAZIONI	OEM
56449	LERDA Presse: Modelli fino al 1985, Rotob.: Modelli 2°Tipo	29.0.08

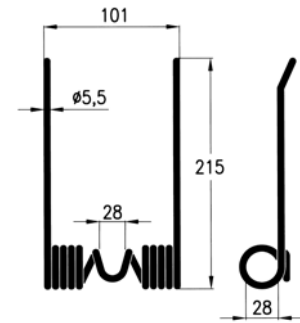

ARTICOLO	APPLICAZIONI	OEM
55871	SAIMM larga modelli vecchi	04.07.27

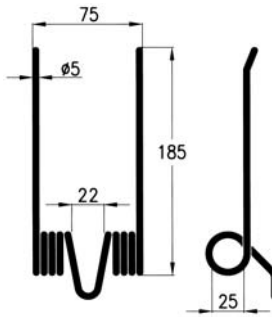

ARTICOLO	APPLICAZIONI	OEM
55592	SAIMM stretta modelli nuovi	11.07.1555

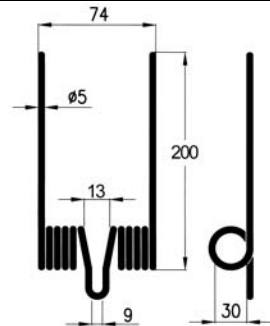

ARTICOLO	APPLICAZIONI	OEM
56450	AGRIFULL/SAIMM stretta - ultime serie - T.M.A. vendrame BEVILACQUA presse	

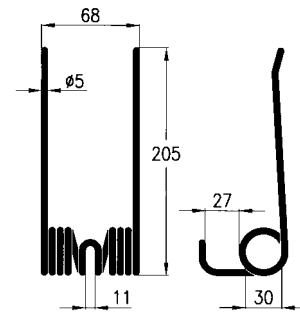

ARTICOLO	APPLICAZIONI	OEM
56451	ITALO SVIZZERA strettissima dal 1982 * impiego standard su ultime serie costruite	761.1062

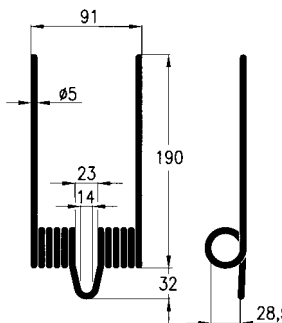

ARTICOLO	APPLICAZIONI	OEM
56452	HESSTON 2ª serie - presse balle giganti Mod. 4700 - 4800	7803746

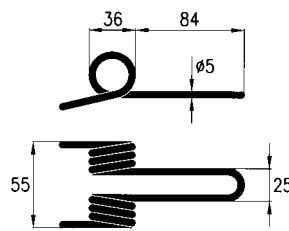

ARTICOLO	APPLICAZIONI	OEM
56453	SGORBATI NEW HOLLAND	SG48753 1111/1026 NH48753

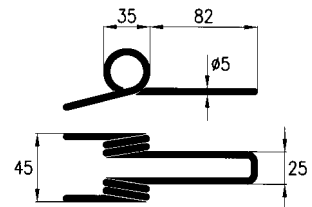

ARTICOLO	APPLICAZIONI	OEM
55599	GALLIGNANI Tutti i modelli 1ª serie	88.76.202

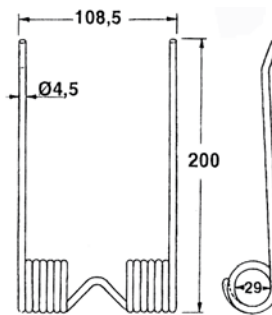

ARTICOLO	APPLICAZIONI	OEM
56670	Mc CORMICK larga Mod. B46 - B47	MA 74528

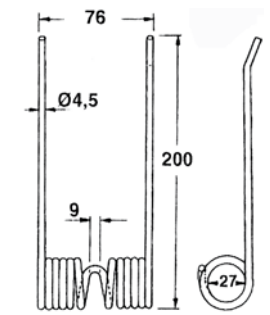

ARTICOLO	APPLICAZIONI	OEM
56671	Mc CORMICK stretta Mod.420-422-430-435-440	726.844- R1

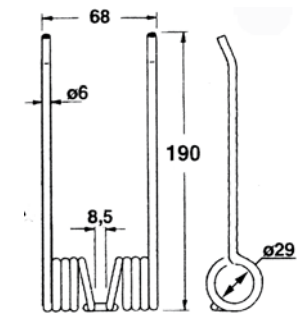

ARTICOLO	APPLICAZIONI	OEM
56672	CLAAS rotopresse Presse balle giganti	CLAAS:918.239.0 Rif: RS 269

segue DENTI PER PRESSA RACCOLTRICE

DENTS POUR PRESSE-RAMASSEUSE - SELF-LOADERS FINGERS - ZINKEN FÜR PRESSE-ZUSAMMENTRAG - MUELLES PARA PRENSA-COSECHADORAS

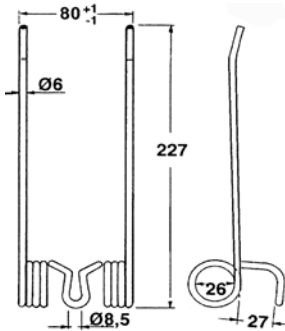

ARTICOLO	APPLICAZIONI	OEM
56673	SAIMM MOD.136 attacco ITALO SVIZZERA	06.07.3663

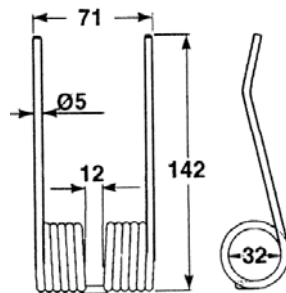

ARTICOLO	APPLICAZIONI	OEM
56674	HESSTON MOD.4800-4860-4860S-4860C-4880S NEW HOLLAND MOD.D1010-D1210	HESSTON 84012422

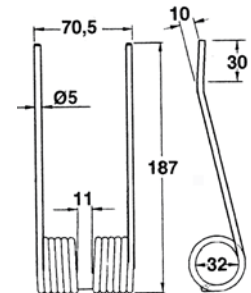

ARTICOLO	APPLICAZIONI	OEM
56675	NEW HOLLAND MOD.800-1000-2000	68.33.10

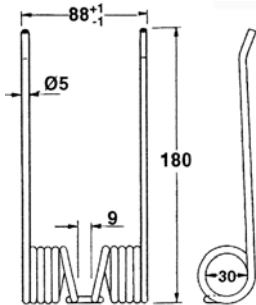

ARTICOLO	APPLICAZIONI	OEM
56676	CICORIA TUTTI I MODELLI	36.03.005

DENTI PER ROTOPRESA RACCOLTRICE

DENTS POUR ROTOPRESSE-RAMASSEUSE - SELF-LOADERS FINGERS - ZINKEN FÜR PRESSE-ZUSAMMENTRAG - MUELLES PARA ROTOPRESA-COSECHADORAS

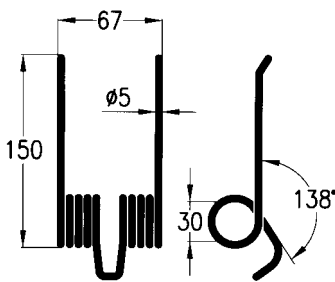

ARTICOLO	APPLICAZIONI	OEM
55861	GALLIGNANI Rotopresse: 1ª - 2ª serie Tutti i modelli	88.76.437

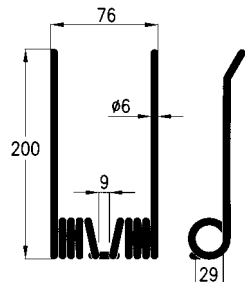

ARTICOLO	APPLICAZIONI	OEM
56454	CLAAS rotopresse Rollant 44-62-85 Attacco bullone Ø 8 mm	807.297.2

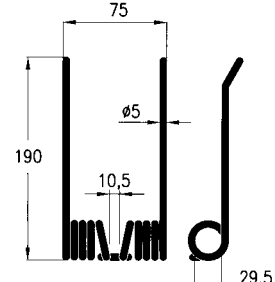

ARTICOLO	APPLICAZIONI	OEM
56455	CLAAS rotopresse Rollant 46-66 Attacco bullone Ø 10 mm	821.421.1

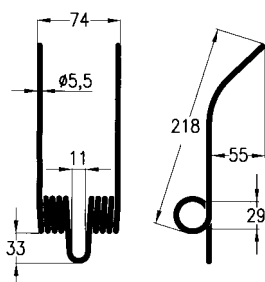

ARTICOLO	APPLICAZIONI	OEM
56456	FERABOLI n° 1 - Mod. 122 - 123 - 2° Tipo laterale Rotopresse fino al 1990	18.28.060

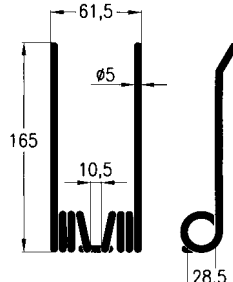

ARTICOLO	APPLICAZIONI	OEM
56457	FAHR Rotopresse a catena GP 2.30 - 2.40 - 3.20	0629.6285

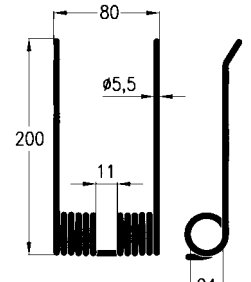

ARTICOLO	APPLICAZIONI	OEM
56458	LERDA C.M. Standard per tutte le rotopresse	

segue DENTI PER ROTOPRESSA RACCOGLITRICE

DENTS POUR ROTOPRESSE-RAMASSEUSE - SELF-LOADERS FINGERS - ZINKEN FÜR PRESSE-ZUSAMMENTRAG - MUELLES PARA ROTOPRESA-COSECHADORAS

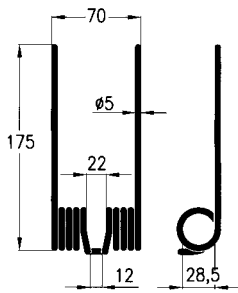

ARTICOLO	APPLICAZIONI	OEM
56459	JOHN DEERE Rotopresse T.V. 1ª serie Mod. 540 - 545 - 550	CC21386

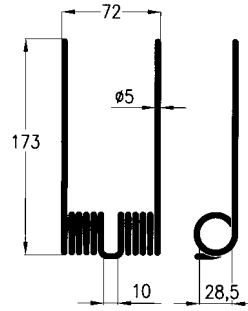

ARTICOLO	APPLICAZIONI	OEM
56460	JOHN DEERE Rotopresse T.N. 2ª serie Mod. 540 - 545 - 550	CC25176

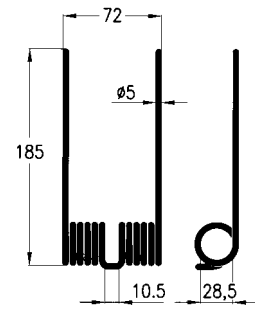

ARTICOLO	APPLICAZIONI	OEM
56461	J. DEERE Rotopresse Mod. 540-545-550 3ª serie Mod. 570-580-590 e attuali	CC 32965

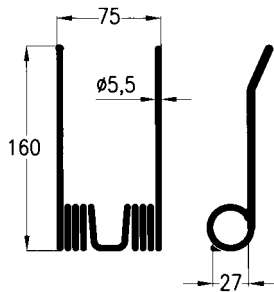

ARTICOLO	APPLICAZIONI	OEM
56462	KRÖNE 1ª serie Mod. 120 - 150 - 180	937.919.0 937.920.0

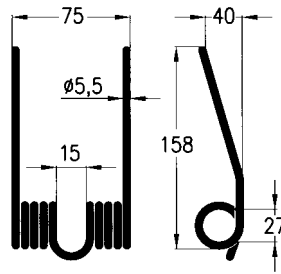

ARTICOLO	APPLICAZIONI	OEM
56463	KRÖNE 3ª serie Mod. 100 - 125 - 155	938.040.1

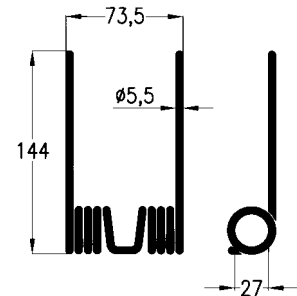

ARTICOLO	APPLICAZIONI	OEM
56464	KRÖNE 4ª serie Mod. 130 - 160	938.158.0

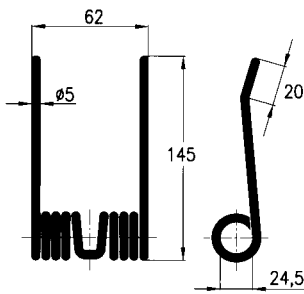

ARTICOLO	APPLICAZIONI	OEM
56465	KRÖNE Mod. 130 S	938.148

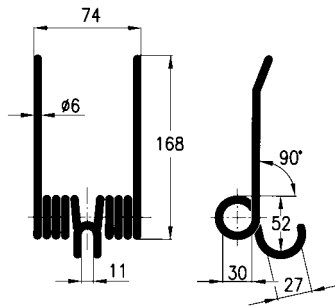

ARTICOLO	APPLICAZIONI	OEM
56257	MORRA filo Ø 6 mm Rotopresse Tutti i mod. fino al 1989	

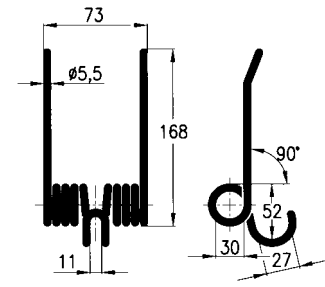

ARTICOLO	APPLICAZIONI	OEM
56466	WOLVO - GUIMA - CARRARO - GUARESÌ - OMAS - SUPERTINO - ABBRIATA - * impiego anche su autocaricanti SCALVENZI - OMAS EUROPA tipo ultimo - FERABOLI n°5	WOLVO 12R001

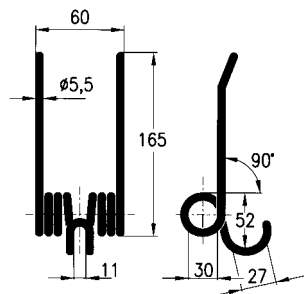

ARTICOLO	APPLICAZIONI	OEM
56468	FORT - SANTINI - GUIMA - I.M.R. - AMA - Costruttori vari	

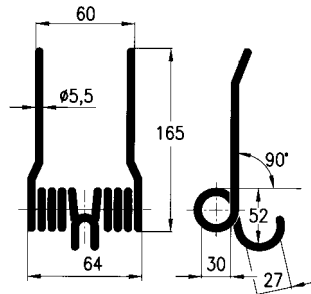

ARTICOLO	APPLICAZIONI	OEM
56469	FORT - MORRA rinforzata Produzione dal 1990	

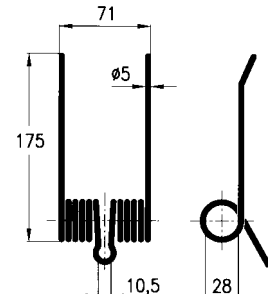

ARTICOLO	APPLICAZIONI	OEM
56470	HESSTON 2ª serie Mod. 5530 - 5540	701700111

segue DENTI PER ROTOPRESSA RACCOGLITRICE

DENTS POUR ROTOPRESSE-RAMASSEUSE - SELF-LOADERS FINGERS - ZINKEN FÜR PRESSE-ZUSAMMENTRAG - MUELLES PARA ROTOPRESA-COSECHADORAS

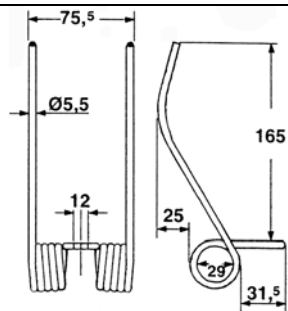

ARTICOLO	APPLICAZIONI	OEM
56677	FERABOLI N°2 Mod. 55 - 56 Rotopresse	18.00.009

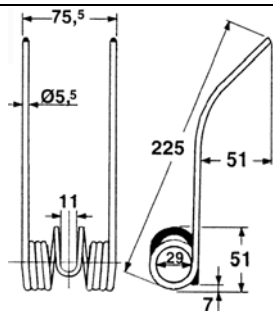

ARTICOLO	APPLICAZIONI	OEM
56678	FERABOLI N°3 Mod. 55-66 Rotopresse 1° tipo centrale	18.00.002

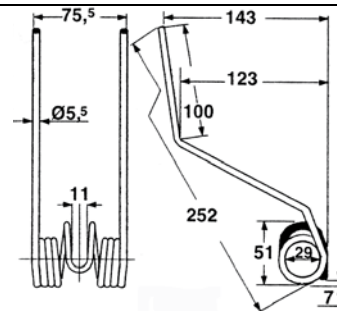

ARTICOLO	APPLICAZIONI	OEM
56679	FERABOLI N°4 Mod. 55-66 Rotopresse 1° tipo laterale	18.00.001

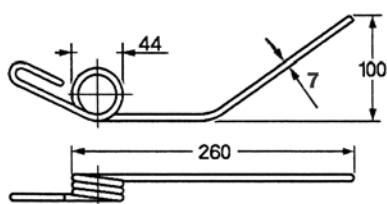

ARTICOLO	APPLICAZIONI	OEM
56680	FERABOLI N°6 Rotopresse RUOTA DX ANDANATRICE PICK-UP	18.31.597

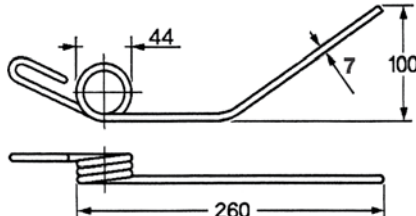

ARTICOLO	APPLICAZIONI	OEM
56681	FERABOLI N°7 Rotopresse RUOTA SX ANDANATRICE PICK-UP	18.31.596

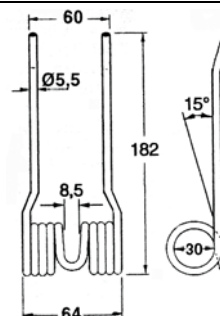

ARTICOLO	APPLICAZIONI
56682	FORT-MORRA TIPO STRETTA Produzione dal 2001

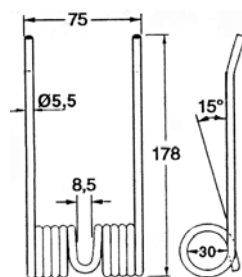

ARTICOLO	APPLICAZIONI
56683	WOLAGRI-MASCAR-SUPERTINO TIPO LARGA Produzione dal 2001

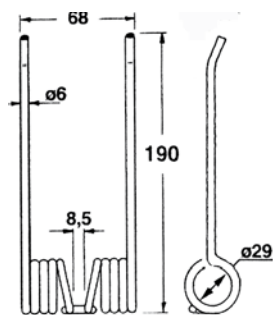

ARTICOLO	APPLICAZIONI	OEM
56684	CLAAS ROTOPRESSE VARIANT	918.238.0 RS 090

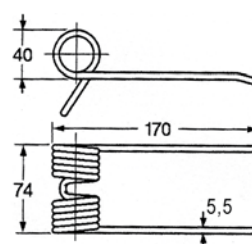

ARTICOLO	APPLICAZIONI	OEM
56922	FERABOLI NUOVI MODELLI	18P0003

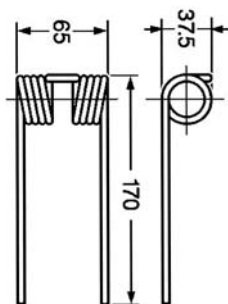

ARTICOLO	APPLICAZIONI	OEM
57295	VICON Rotopresse: RV1601	VF16618868

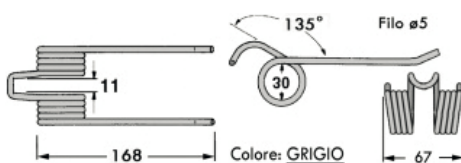

ARTICOLO	APPLICAZIONI	OEM
57424	GALLIGNANI Mod. ROBOT - FARMER	88.76.521

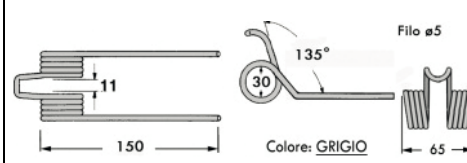

ARTICOLO	APPLICAZIONI	OEM
57425	GALLIGNANI Rotoballe	88.76.501

segue DENTI PER ROTOPRESSA RACCOGLITRICE

DENTS POUR ROTOPRESSE-RAMASSEUSE - SELF-LOADERS FINGERS - ZINKEN FÜR PRESSE-ZUSAMMENTRAG - MUELLES PARA ROTOPRENSA-COSECHADORAS

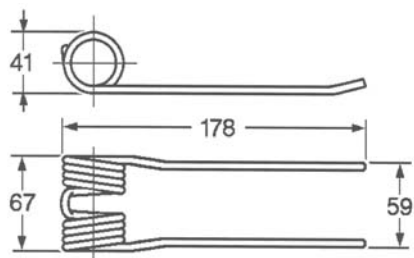

ARTICOLO	APPLICAZIONI	OEM
57474	KRONE Filo Ø 5,5	-

new

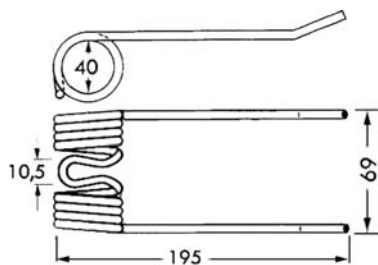

ARTICOLO	APPLICAZIONI	OEM
57611	MASCAR Filo Ø 5	51000170

CINGHIE PER ROTOPRESSE

COURROIES POUR PRESSES A BALLEES - BELTS FOR BALERS - BALLENPRESSEKEILRIEMEN - CORREAS PARA EMBALADORAS



CINGHIE PER ROTOPRESA IN ROTOLI DA 56 MT

COURROIES POUR PRESSES A BALLEES (56m)

BELTS FOR BALERS (56m)

BALLENPRESSEKEILRIEMEN (56m)

CORREAS PARA EMBALADORAS (56m)

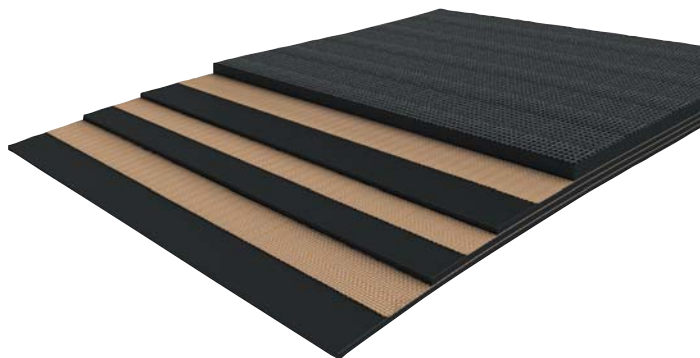

CARATTERISTICHE

Cinghia professionale High Grip con tele speciali in poliester e poliammide e coperture in gomma antiabrasiva ed antistrappo, che ben si adattano alla vostra rotopressa a camera variabile.

Viene fornita in rotoli interi da 56 metri con varie larghezze adattabili alle vostre esigenze e ai vari modelli e marche.

ARTICOLO	LARGHEZZA mm	NUMERO TELE	SPESSORE mm	LUNGHEZZA ROTOLO mt.
57582	120	3	6	56
57583	178	3	6	56
57584	180	3	6	56
57621	210	3	6	56
57585	250	3	6	56

Molle agricole

CULTIVATOR SPRINGS

mato

03

segue CINGHIE PER ROTOPRESSE

COURROIES POUR PRESSES A BALLEES - BELTS FOR BALERS - BALLENPRESSEKEILRIEMEN - CORREAS PARA EMBALADORAS

GRAFFE PER GIUNZIONI MATO

AGRAFE POUR COURROIE MATO
BELT FASTENER FOR MATO
MATO-GURTVBINDER
CONECTOR DE CORREA POR MATO



U24



H24

TIPO U24BS - TENUTA MAX: 520 kN/m

ARTICOLO	SCATOLA COMPOSTA DA:	LARGHEZZA GIUNZIONE mm	LARGHEZZA CINGHIA mm	SPESSORE CINGHIA mm	LUNGHEZZA PERNO COLLEGAMENTO mm
57567	12 strisce da 12 graffe + 6 barrette	132	155 - 165	5,0 - 6,0	143
57633	12 strisce da 13 graffe + 6 barrette	143	166 - 176	5,0 - 6,0	154
57634	12 strisce da 14 graffe + 6 barrette	154	177 - 187	5,0 - 6,0	165
57568	12 strisce da 15 graffe + 6 barrette	165	188 - 198	5,0 - 6,0	176
57569	10 strisce da 17 graffe + 5 barrette	187	210 - 220	5,0 - 6,0	198
57570	10 strisce da 18 graffe + 5 barrette	198	221 - 231	5,0 - 6,0	209
57571	8 strisce da 23 graffe + 4 barrette	253	276 - 286	5,0 - 6,0	264

TIPO U24CS - TENUTA MAX: 520 kN/m

ARTICOLO	SCATOLA COMPOSTA DA:	LARGHEZZA GIUNZIONE mm	LARGHEZZA CINGHIA mm	SPESSORE CINGHIA mm	LUNGHEZZA PERNO COLLEGAMENTO mm
57635	12 strisce da 13 graffe + 6 barrette	143	166 - 176	6,0 - 7,0	154
57636	12 strisce da 14 graffe + 6 barrette	154	177 - 187	6,0 - 7,0	165
57572	12 strisce da 15 graffe + 6 barrette	165	188 - 198	6,0 - 7,0	176
57637	10 strisce da 16 graffe + 5 barrette	176	199 - 209	6,0 - 7,0	187
57573	10 strisce da 17 graffe + 5 barrette	187	210 - 220	6,0 - 7,0	198
57574	10 strisce da 18 graffe + 5 barrette	198	221 - 231	6,0 - 7,0	209
57575	8 strisce da 23 graffe + 4 barrette	253	276 - 286	6,0 - 7,0	264
57638	8 strisce da 25 graffe + 4 barrette	275	298 - 308	6,0 - 7,0	286

TIPO H24BS - TENUTA MAX: 520 kN/m

ARTICOLO	SCATOLA COMPOSTA DA:	LARGHEZZA GIUNZIONE mm	LARGHEZZA CINGHIA mm	SPESSORE CINGHIA mm	LUNGHEZZA PERNO COLLEGAMENTO mm
57577	12 strisce da 15 graffe + 6 barrette	165	188 - 198	5,0 - 6,0	176
57578	10 strisce da 17 graffe + 5 barrette	187	210 - 220	5,0 - 6,0	198
57579	10 strisce da 18 graffe + 5 barrette	198	221 - 231	5,0 - 6,0	209
57580	8 strisce da 23 graffe + 4 barrette	253	276 - 286	5,0 - 6,0	264

KIT ASTE PER GRAFFE U24 - H24 MATO

KIT TIGES D'AGRAFES U24 - H24 MATO
ROD KIT FOR CLIPS U24 - H24 MATO
KIT STANGEN FÜR VERBINDER U24 - H24 MATO
KIT VARILLAS PARA GRAPAS U24 - H24 MATO

new



NB: per una corretta manutenzione delle graffe, si consiglia la sostituzione delle aste una volta all'anno.

ARTICOLO	MISURE ASTA mm	LARGHEZZA CINGHIA mm
57601	6x143	155 - 165
57639	6x154	166 - 176
57640	6x165	177 - 187
57602	6x176	188 - 198
57641	5x187	199 - 209
57603	5x198	210 - 220
57604	5x209	221 - 231
57605	4x264	276 - 286
57642	4x286	298 - 308

ACCESSORI PER CINGHIE ROTOPRESSE

ACCESSOIRES POUR COURROIES PRESSES A BALLEES - ACCESSORIES FOR BELTS BALERS - ZUBEHÖR FÜR BALLENPRESSEKEILRIEMEN - ACCESORIOS PARA CORREAS EMBALADORAS

GRAFFATRICE MATO PROFI 19 e 25 PER GIUNZIONI U24

AGRAFE MATO PROF19-25 POUR POINTS U24
PROFI19-25 MATO FASTENER FOR U24 STITCHES
SCHRAUBSTOCKAPPARAT PROFI 19-25 U24
CONECTORA MATO PROF19-25 POR PUNTADAS U24



RICAMBI



Scalpello

57644

ARTICOLO	LARGHEZZA mm
57576	209
57643	275

GRAFFATRICE MATO ECO 180 PER GIUNZIONI H24

AGRAFE MATO ECO180 POUR POINTS H24
ECO180 MATO FASTENER FOR H24 STITCHES
SCHRAUBSTOCKAPPARAT ECO 180-H24
CONECTORA MATO ECO180 POR PUNTADAS H24



ARTICOLO	LARGHEZZA mm
57581	180

TAGLIERINA PORTATILE PER CINGHIE

COUPEUSE PORTABLE POUR COURROIES
PORTABLE CUTTING DEVICE FOR BELTS
TRAGBARES SCHNEIDGERÄT FÜR GURTE
CORTADORA PORTÁTIL PARA CORREAS

new



ARTICOLO	LARGHEZZA MAX CINGHIE mm
57606	300

KIT AGGANCIATRICE CINGHIE - U24

KIT DISPOSITIF D'ACCROCHAGE COURROIES - U24
BELT FITTING KIT - U24
KIT GURTEINHÄNGEMASCHINE - U24
KIT DE ENGANCHE CORREAS - U24

new

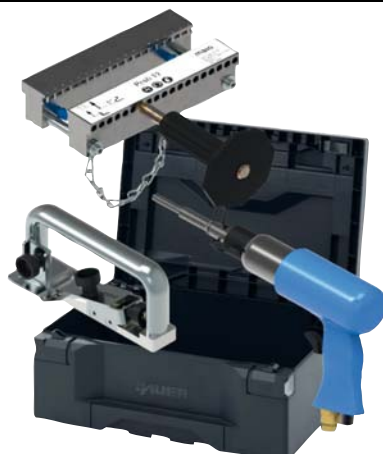

ARTICOLO
57607

Composto da:

- Graffatrice Profi 19
- Taglierina per cinghie 18
- Martelletto pneumatico con punzone
- Valigetta in plastica

RICAMBI



Martello
pneumatico per
graffe U24-H24

57645



Scalpello di
ricambio

57646

DENTI ASPO MIETITREBBIA

DENTS ASPO MOISSENEUSE-BATTEUSE - ASPO-HARVESTER-THRESHER FINGERS - ZINKEN ASPO MAEHDRESCHER - MUELLES ASPO COSECHADORA

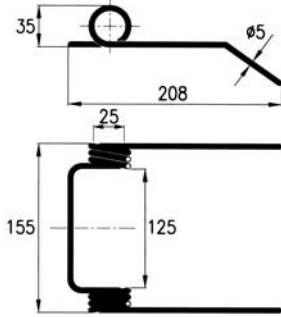

ARTICOLO	APPLICAZIONI	OEM
56471	ARBOS doppio	B15508

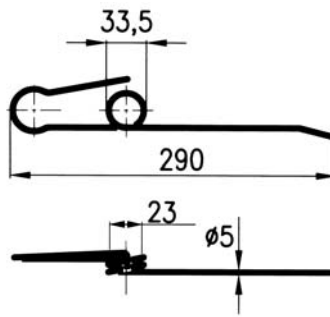

ARTICOLO	APPLICAZIONI	OEM
56472	ARBOS semplice	B50143

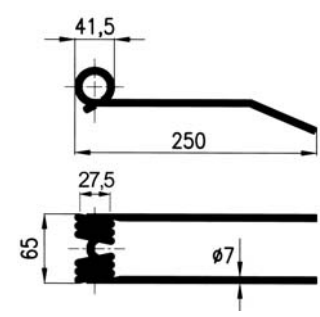

ARTICOLO	APPLICAZIONI	OEM
56473	FAHR doppio	

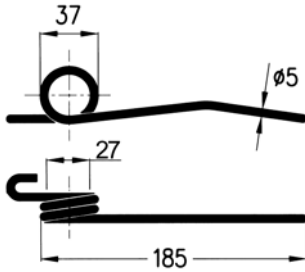

ARTICOLO	APPLICAZIONI	OEM
56474	JOHN DEERE	Z20478

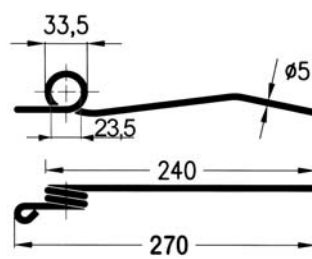

ARTICOLO	APPLICAZIONI	OEM
56475	LOVA	23004A

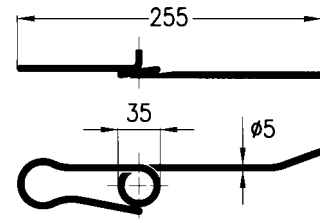

ARTICOLO	APPLICAZIONI	OEM
56477	MASSEY FERGUSON - tipo corto	

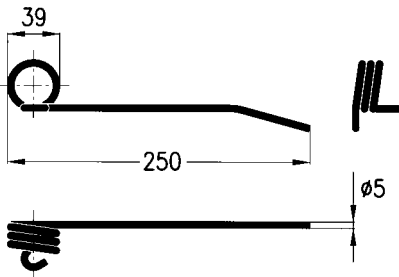

ARTICOLO	APPLICAZIONI	OEM
56478	CLAAS	690309

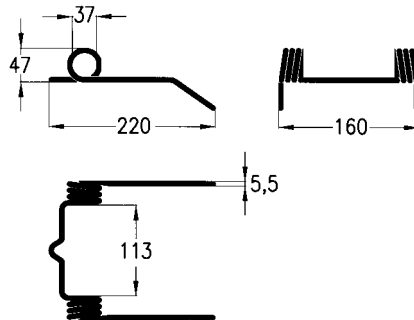

ARTICOLO	APPLICAZIONI	OEM
55869	NEW HOLLAND - CLAYSON	334016 433415

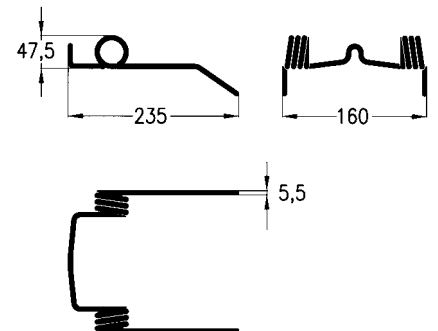

ARTICOLO	APPLICAZIONI	OEM
55870	NEW HOLLAND	435428

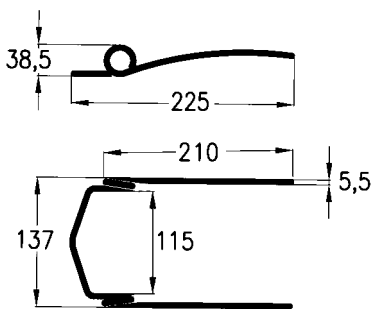

ARTICOLO	APPLICAZIONI	OEM
55864	LAVERDA	12449

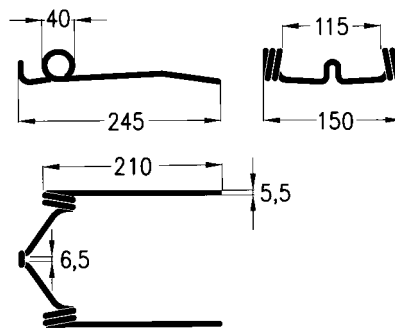

ARTICOLO	APPLICAZIONI	OEM
55865	LAVERDA	114786

ATTACCHI FERMADENTE

ATTELAGE ARRET RESORT - STOP-SPRING ATTACHEMENTS - FIXIER SCHEIBE - ATAQUE PARADO DIENTES

BLOCCHETTO SUPERIORE APPOGGIO TUBO

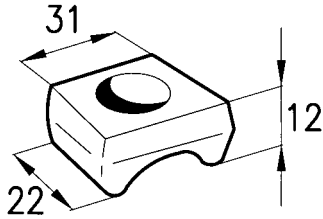

ARTICOLO	APPLICAZIONI
56260	FAHR - GALFRÈ - FELLA - LINCE - FORT - B.C.S.

FERMADENTE INFERIORE STANDARD

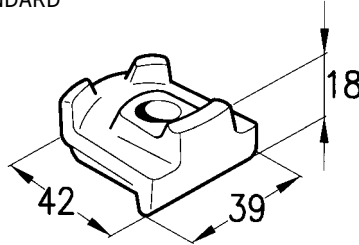

ARTICOLO	APPLICAZIONI
56259	FAHR - GALFRÈ - FELLA - LINCE - FORT - B.C.S.

FERMADENTE INIZIALE "FONTANESI"

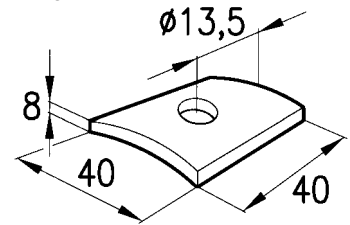

ARTICOLO	APPLICAZIONI
56261	FONTANESI - SLAM

FERMADENTE STANDARD GIROANDANATORI GIRELLI "GALFÈ"

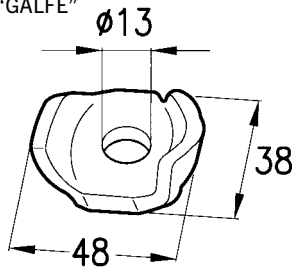

ARTICOLO	APPLICAZIONI
56479	GALFRÈ / Universale standard per girelli/ giroandatori Tipi vecchi - Tipi attuali

FERMADENTE "STOLL"

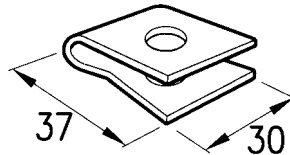

ARTICOLO	APPLICAZIONI
56262	STOLL - N. HOLLAND - POËTTINGER - FIORINI - MARANGON

FERMADENTE STANDARD GIROANDANATORI

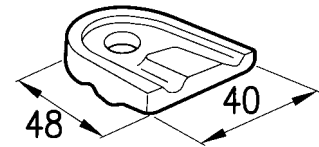

ARTICOLO	APPLICAZIONI
56264	FAHR - FORT - GALFRÈ - FONTANESI - MORRA - SLAM - REPOSSI

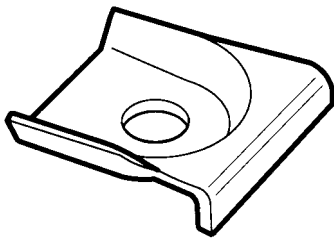

ARTICOLO	APPLICAZIONI
56258	RANGHINATORI REPOSSI

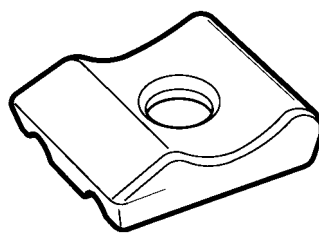

ARTICOLO	APPLICAZIONI
56263	GIROANDANATORE KUHN

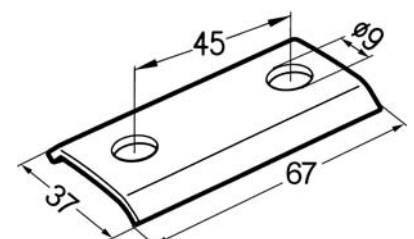

ARTICOLO	APPLICAZIONI
56265	SEMINATRICI CARRARO - NODET

TASSELLO FERMADENTE RANGHINATORE "SGORBATI"

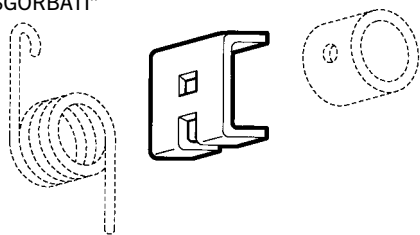

TASSELLO FERMADENTE RANGHINATORE "SGORBATI"

ARTICOLO	APPLICAZIONI	OEM
56480	SGORBATI	04/922

TASSELLO FERMADENTE RANGHINATORE STELLARE "ORIONE"

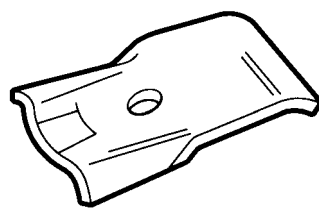

FERMADENTE RANGHINATORE STELLARE "ORIONE"

ARTICOLO	APPLICAZIONI	OEM
56481	ORIONE	294036A

TASSELLO FERMADENTE RANGHINATORE STELLARE "VICON - LELY"

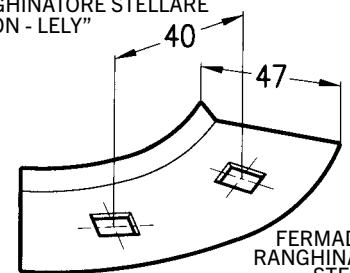

FERMADENTE RANGHINATORE STELLARE "VICON-LELY"

ARTICOLO	APPLICAZIONI
56482	VICON - LELY

segue **ATTACCHI FERMADENTE**
 ATTELAGE ARRET RESORT - STOP-SPRING ATTACHEMENTS - FIXIER SCHEIBE - ATAQUE PARADO DIENTES

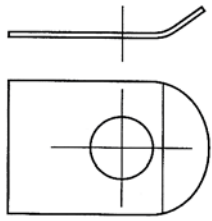

ARTICOLO	APPLICAZIONI
57263	RANGHINATORE CORMICK

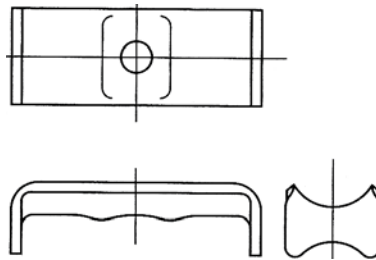

ARTICOLO	APPLICAZIONI
57257	AUTOCARICANTE BERNI EUROPA

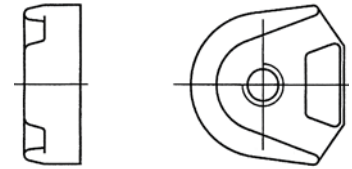

ARTICOLO	APPLICAZIONI	OEM
57258	AUTOCARICANTE MENGELE	04035692

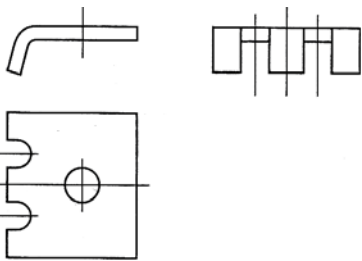

ARTICOLO	APPLICAZIONI
57259	RANGHINATORE FORT F2

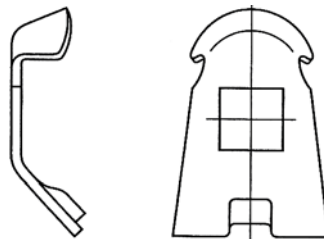

ARTICOLO	APPLICAZIONI
57260	VOLTAFIENO LINCE

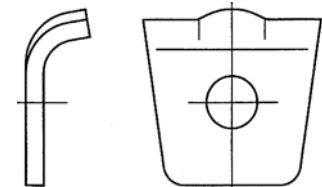

ARTICOLO	APPLICAZIONI	OEM
57264	AUTOCARICANTE KRONE	242004

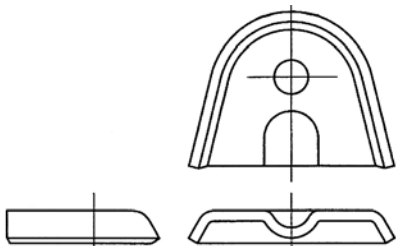

ARTICOLO	APPLICAZIONI	OEM
57261	RANGHINATORE HEUMA	001141

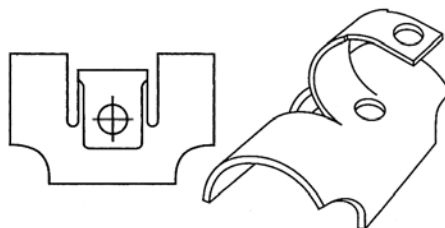

ARTICOLO	APPLICAZIONI	OEM
57262	PRESSA WELGER	0338300000

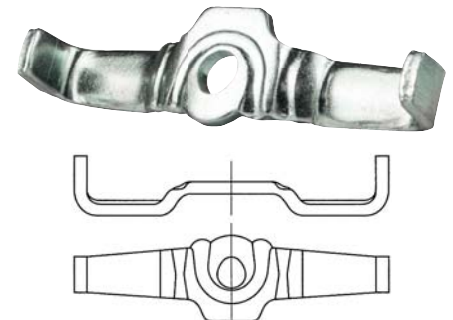

ARTICOLO	APPLICAZIONI	OEM
57265	GIRELLO PZ FANEX	GZ280V

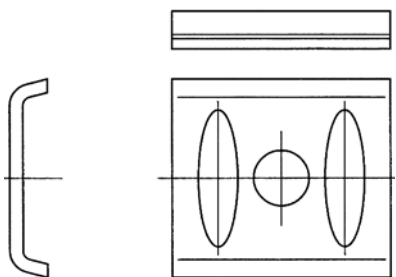

ARTICOLO	APPLICAZIONI	OEM
57266	PIASTRINA FISSAGGIO MORRA	06103038292

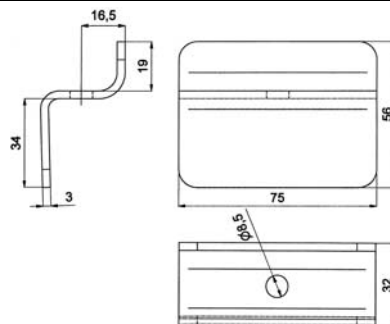

ARTICOLO	APPLICAZIONI	OEM
57296	WOLAGA - MASCAR - SUPERTINO	-



ARTICOLO	APPLICAZIONI	OEM
56483	FAHR Mod. KH - MORRA 2° Tipo	0656.5630.00

segue ATTACCHI FERMADENTE

ATTELAGE ARRET RESORT - STOP-SPRING ATTACHEMENTS - FIXIER SCHEIBE - ATAQUE PARADO DIENTES



ARTICOLO	APPLICAZIONI
56266	VITE Ø 8max25 mm (dado CH 13) rangh. B.C.S. molle varie
56267	VITE Ø 10max25 mm (dado CH 17) molle varie

DENTI SEMINATRICE - STRIGLIATRICE

DENTS HERSE SEMOIR - TINES FOR SOWNG MACHINE - EGGENZINKE SAEMASCHINE - HACKERMASCHINE - DIENTES PARA GRADAS SEMBRADORA

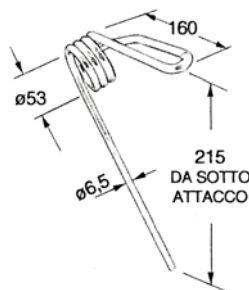

ARTICOLO	APPLICAZIONI
55880	NODET - CARRARO Dente ANTERIORE seminatrice Standard costruttori vari

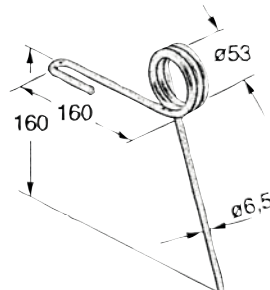

ARTICOLO	APPLICAZIONI
55881	NODET - CARRARO Dente POSTERIORE seminatrice Standard costruttori vari

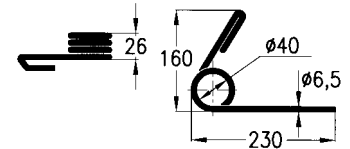

ARTICOLO	APPLICAZIONI
56435	OMA anteriore destra

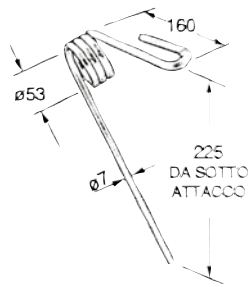

ARTICOLO	APPLICAZIONI
56436	IMA LAROCCA Dente ANTERIORE seminatrice Standard costruttori vari

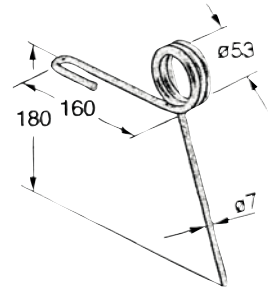

ARTICOLO	APPLICAZIONI
56437	IMA LAROCCA Dente POSTERIORE seminatrice Standard costruttori vari

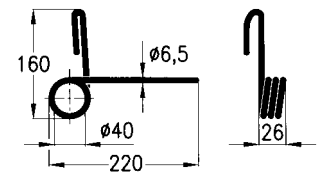

ARTICOLO	APPLICAZIONI
56438	OMA posteriore sinistra

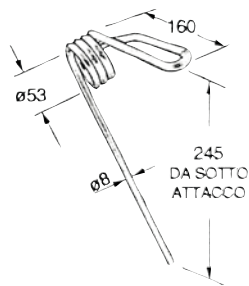

ARTICOLO	APPLICAZIONI
56439	Seminatrice MARZIA Dente ANTERIORE seminatrice

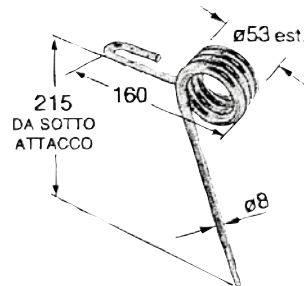

ARTICOLO	APPLICAZIONI
56440	Seminatrice MARZIA Dente POSTERIORE seminatrice

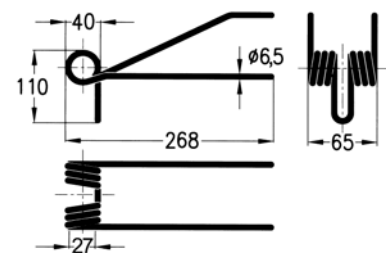

ARTICOLO	APPLICAZIONI
56441	MORENI - DAMAX

segue DENTI SEMINATRICI - STRIGLIATRICE

DENTS HERSE SEMOIR - TINES FOR SOWING MACHINE - EGGENZINKE SAEMASCHINE - HACKERMASCHINE - DIENTES PARA GRADAS SEMBRADORA

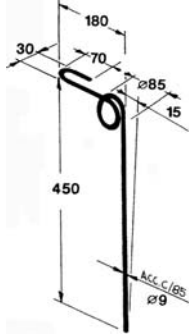

ARTICOLO	APPLICAZIONI
56685	GASPARDO-CELLI-KÖNGSKILDE Dente STRIGLIATORE seminatrici

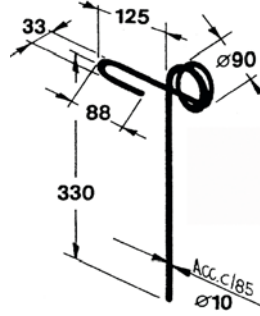

ARTICOLO	APPLICAZIONI
55471	BIANCHI/Piadena tipo corto Dente STRIGLIATORE seminatrici

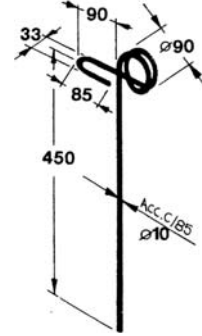

ARTICOLO	APPLICAZIONI
56686	Costruttori VARI tipo lungo Dente STRIGLIATORE seminatrici

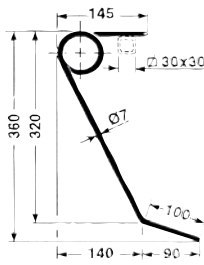

ARTICOLO	APPLICAZIONI	OEM
56923	Seminatrice GASPARDO Dente Anteriore Produzione fino al 2000	18902790

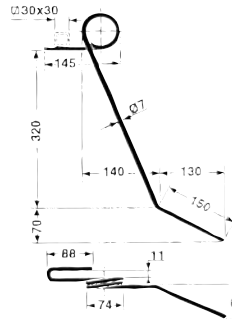

ARTICOLO	APPLICAZIONI	OEM
56924	Seminatrice GASPARDO Dente Posteriore Produzione fino al 2000	18902800



ARTICOLO	APPLICAZIONI
55472	BRIDA con rondella e dado per codici 55471 e 56686

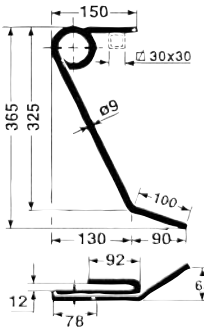

ARTICOLO	APPLICAZIONI	OEM
56925	Seminatrice GASPARDO Dente Anteriore Produzione dal 2001	18903640

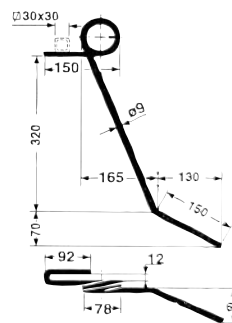

ARTICOLO	APPLICAZIONI	OEM
56926	Seminatrice GASPARDO Dente Posteriore Produzione dal 2001	18903650

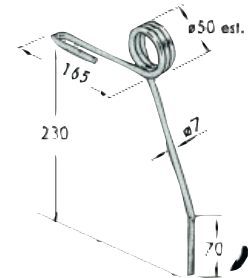

ARTICOLO	APPLICAZIONI
57428	MASCAR Dente CORTO Seminatrici

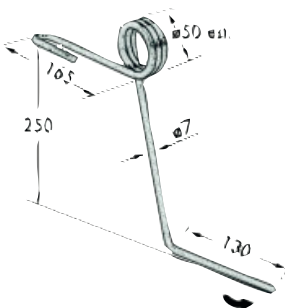

ARTICOLO	APPLICAZIONI
57429	MASCAR Dente LUNGO Seminatrici

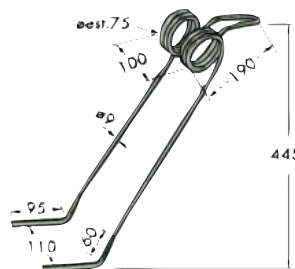

ARTICOLO	APPLICAZIONI	OEM
57430	GASPARDO ALPEGO	G189.047.10 MF5A00026

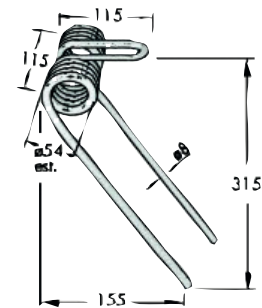

ARTICOLO	APPLICAZIONI	OEM
57431	GASPARDO	G169.400.91

segue DENTI SEMINATRICE - STRIGLIATRICE

DENTS HERSE SEMOIR - TINES FOR SOWNG MACHINE - EGGENZINKE SAEMASCHINE - HACKERMASCHINE - DIENTES PARA GRADAS SEMBRADORA

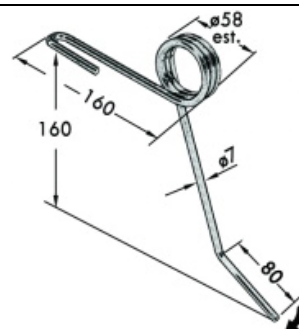
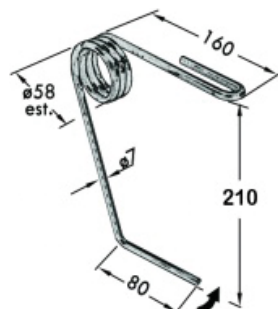
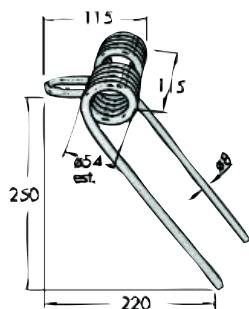

ARTICOLO	APPLICAZIONI	OEM
57432	GASPARDO	G189.041.90

ARTICOLO	APPLICAZIONI	OEM
57433	ABA Group	-

ARTICOLO	APPLICAZIONI	OEM
57434	ABA Group	-

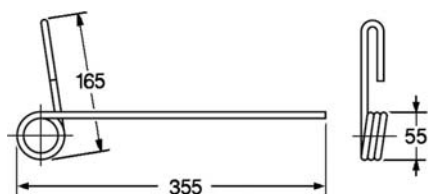

ARTICOLO	APPLICAZIONI	OEM
57692	VERTULLI Filo Ø 8,0 mm	-

ACCESSORI PER SEMINATRICE

ACCESSOIRES POUR SEMOIR - ACCESSORIES FOR SOWING-MACHINE - ZUBEHÖRE FÜR SÄEMASCHINE - ACCESORIOS POR SEMBRADORA

BOCCHETTA

BOUCHE
SEED OUTLET
TÜLLE
BOCA



ARTICOLO
56687

CHIUSURA

FERMETURE
CLOSING FLAP
VERSCHLUSS
CIERRE



ARTICOLO
56688

ANTI INTASAMENTO

ANTI BOURRAGE
ANTI-CLOGGING FLAP
VERSTOPFUNGSSCHUTZ
ANTI ATASCAMIENTO



ARTICOLO
56689

DEVIATORE SEMI

DEVIATEUR SEMENCES
SEED DEFLECTOR
SAATABLEITER
DESVIADOR DE SEMILLAS



ARTICOLO
56690

RULLINO SEMI GROSSI

ROUE SEMENCES GROSSES
LARGE SEED WHEEL
GROBSÄRAD
RODILLO MEDIO GRANDE



ARTICOLO
56691

RULLINO DUE CORONE

ROUE DEUX COURONNES
DOUBLE-ROW WHEEL
DOPPELNOCKENRAD
RODILLO DOS CORONAS

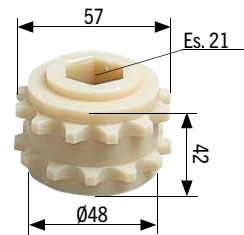

ARTICOLO
56692

RULLINO DOPPIA VERSIONE

ROUE DOUBLE VERSION
WHEEL - DOUBLE VERSION
SÄRAD DOPPELVERSION
RODILLO DOBLE VERSIÓN

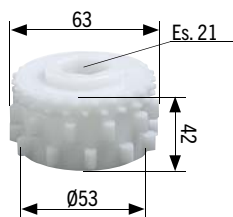

ARTICOLO
56693

RULLINO SOIA

ROUE A SOJA
SOYBEAN WHEEL
SOJASÄRAD
RODILLO SOJA

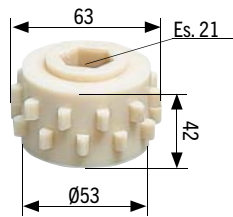

ARTICOLO
56694

CUNETTA

RIGOLE
DEFLECTOR PLATE
RINNE
CUÑA



ARTICOLO
56695

MOLLA A SPIRALE

RESSORT A SPIRALE
SPIRAL SPRING
SPIRALFEDER
MUELLE DE ESPIRAL



ARTICOLO
56696

MOLLA SAGOMATA

RESSORT FAÇONNE
SHAPED SPRING
GEFORMTE FEDER
MUELLE MOLDURADO

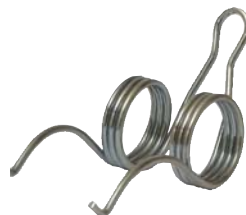

ARTICOLO
56697

RONDELLA

RONDELLE
WASHER
UNTERLEGSSCHEIBE
ARANDELA



ARTICOLO
56698

segue ACCESSORI PER SEMINATRICE

ACCESSOIRES POUR SEMOIR - ACCESSORIES FOR SOWING-MACHINE - ZUBEHÖRE FÜR SÄEMASCHINE - ACCESORIOS POR SEMBRADORA

REGISTRO

REGISTRE
ADJUSTER
REGISTRIERTEIL
REGULACIÓN



ARTICOLO
56699

SOFFIETTO CONICO

SOUFFLET CONIQUE
TAPERED FUNNEL
KEGELBALG
FUELLE CÓNICO



ARTICOLO
56701

TUBO CONDUCISEMI CORTO

TUBE GUIDE SEMENCE COURT
SHORT SEED TUBE
SAATLEITROHR KURZ
TUBO CONDUCCIÓN SEMILLAS CORTO

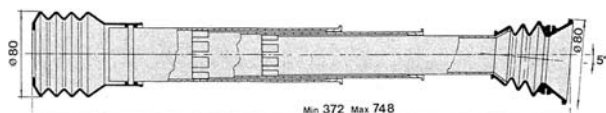

ARTICOLO
56703

TUBO PER SEMINATRICE PASSAGGIO ARIA SEME IN POLIURETANO TRASPARENTE CON SPIRALE AVORIO

TUBE POUR SEMOIR PASSAGE AIR SEMENCE EN POLYURETHANNE TRANSPARENT AVEC SPIRALE IVOIRE
AIR-SEED HOSE FOR SEED DRILLS IN TRANSPARENT POLYURETHANE
SCHLAUCH FÜR SÄMASCHINE LUFTDURCHGANG SAAT AUS KLARSICHTPOLYURETHAN MIT ELFENBEINFARBIGER SPIRALE
TUBO PARA SEMBRADORA PASAJE AIRE SEMILLA DE POLIURETANO TRANSPARENTE CON ESPIRAL MARFIL



ARTICOLO	Ø mm	DESCRIZIONE	LUNGHEZZA ROTOLI m
27060	32	-	20
27061	35	-	20
27062	40	-	20

IMBUTO PER TUBO CONDUCI SEMI

ENTONNOIR POUR TUBE GUIDE SEMENCES
SEED TUBE FUNNEL
TRICHTER FÜR SAATLEITROHR
EMBUDO PARA TUBO CONDUCCIÓN SEMILLAS



ARTICOLO
56700

SOFFIETTO CILINDRICO

SOUFFLET CYLINDRIQUE
CYLINDRICAL FUNNEL
ZYLINDERBALG
FUELLE CILINDRICO



ARTICOLO
56702

TUBO CONDUCISEMI LUNGO

TUBE GUIDE SEMENCE LONG
LONG SEED TUBE
SAATLEITROHR LANG
TUBO CONDUCCIÓN SEMILLAS LARGO

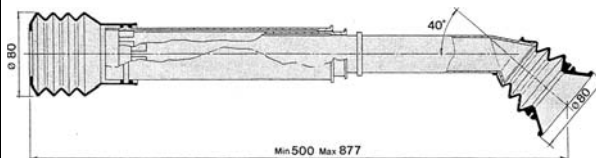

ARTICOLO
56704

TUBO PER SEMINATRICE ASPIRAZIONE ARIA SERIE LEGGERA

TUE POUR SEMOIR ASPIRATION AIR SERIE LEGERE
AIR INTAKE HOSE FOR SEED DRILLS - LIGHTWEIGHT SERIES
SCHLAUCH FÜR SÄMASCHINE LUFTANSAUGUNG LEICHTE SERIE
TUBO PARA SEMBRADORA ASPIRACIÓN AIRE SERIE LIGERA



ARTICOLO	Ø mm	DESCRIZIONE	LUNGHEZZA ROTOLI m
27058	32	COLORE GRIGIO	30
26484	35	COLORE GRIGIO	30
27059	40	COLORE GRIGIO	30

VOMERI PER ARATRI NON FORATI

SOCS POUR CHARRUES NON PERCES - PLOUGHSHARES WITHOUT HOLE - PFLUGSCHAREN OHNE LOCH - REJAS PARA ARADOS NO PERFORADAS

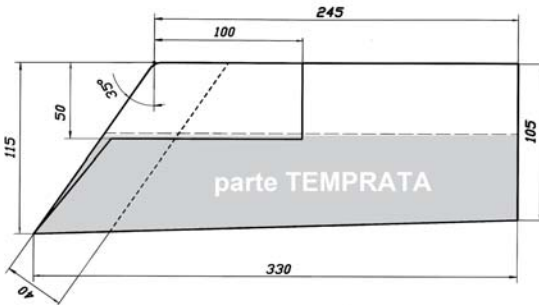

Il disegno rappresenta il particolare DX

ARTICOLO DX	ARTICOLO SX	APPLICAZIONI
56744	56745	Vomerino spalla 240mm rinforzato

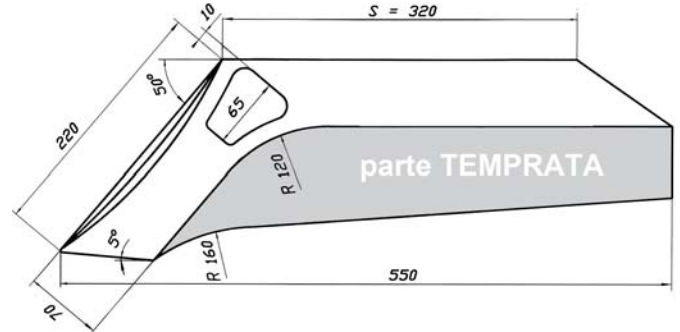

Il disegno rappresenta il particolare DX

ARTICOLO DX	ARTICOLO SX	APPLICAZIONI
56746	56747	Vomero tipo universale spalla 320

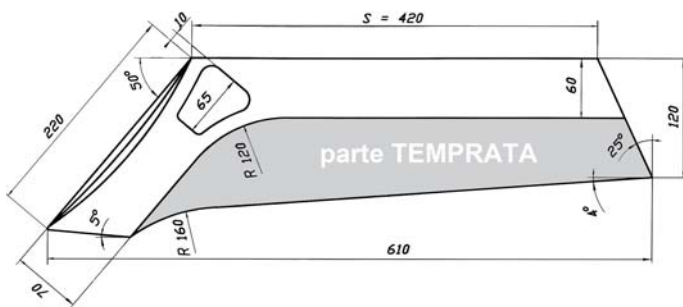

Il disegno rappresenta il particolare DX

ARTICOLO DX	ARTICOLO SX	APPLICAZIONI
56748	56749	Vomero tipo universale spalla 420

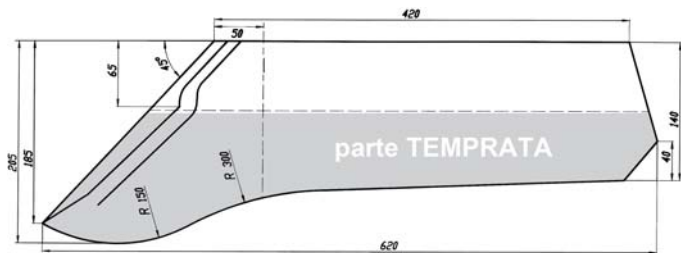

Il disegno rappresenta il particolare DX

ARTICOLO DX	ARTICOLO SX	APPLICAZIONI
56750	56751	Vomero adatt. per aratri MORO-KUHN e vari

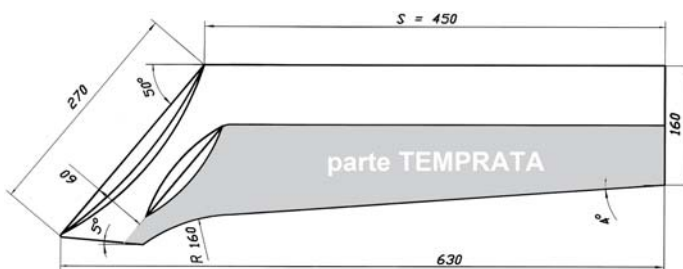

Il disegno rappresenta il particolare DX

ARTICOLO DX	ARTICOLO SX	APPLICAZIONI
56754	56755	Vomero tipo universale spalla 450

RICAMBI PER ARATRI

RECHANGES POUR CHARRUES - EXCHANGES FOR PLOUGHS - ERSATZTEILEN FUER PFLUGE - RECAMBIOS PARA ARADOS

VOMERI - EMMEGIEMME - MIPE - VIVIANI

SOC - EMMEGIEMME - MIPE - VIVIANI
SHARE - EMMEGIEMME - MIPE - VIVIANI
SCHARE - EMMEGIEMME - MIPE - VIVIANI
REJAS - EMMEGIEMME - MIPE - VIVIANI

VOMERINI - EMMEGIEMME - MIPE - VIVIANI

SOCS DE RASETTE - EMMEGIEMME - MIPE - VIVIANI
SKIM POINTS - EMMEGIEMME - MIPE - VIVIANI
DUNGereinLEGERSCHARE - EMMEGIEMME - MIPE - VIVIANI
REJAS - EMMEGIEMME - MIPE - VIVIANI

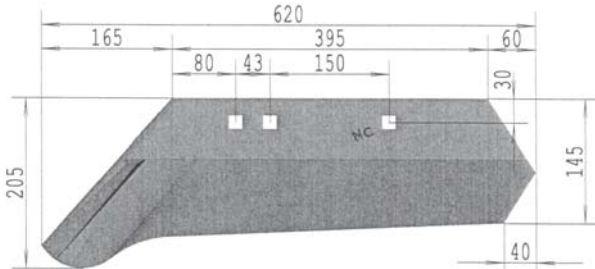

Il disegno rappresenta il particolare DX

ARTICOLO	DESCRIZIONE	OEM
57354	Vomere Destro	-
57355	Vomere Sinistro	-

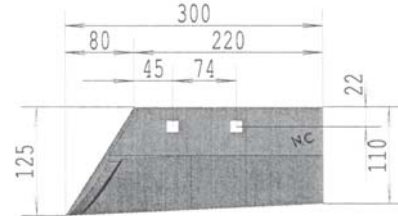

Il disegno rappresenta il particolare DX

ARTICOLO	DESCRIZIONE	OEM
57356	Vomerino Destro	-
57357	Vomerino Sinistro	-

RICAMBI ADATTABILI SU CORPI TIPO ERMO

PIECES POUR CORPS TYPE ERMO
SPARE PARTS ADJUSTABLE ON BODIES TYPE ERMO
ERSATZTEILE FÜR KÖRPER TYP ERMO
REPUESTOS ADAPTABLES SOBRE CUERPOS TIPO ERMO

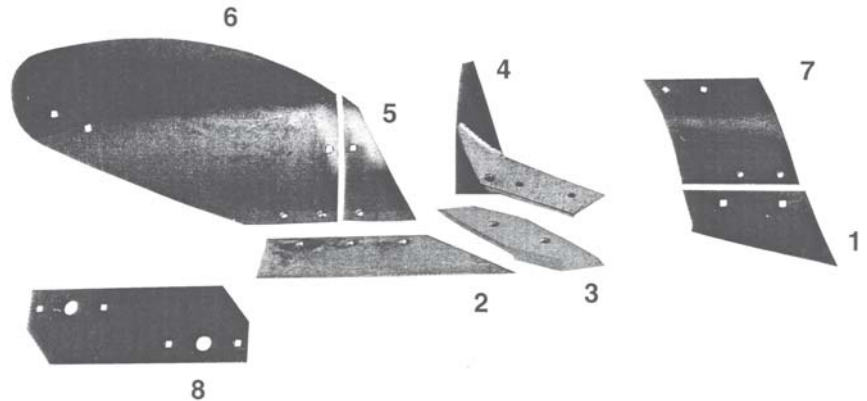

ARTICOLO		DESCRIZIONE	RIF.
SX	DX		
56824	56716	VOMERE PER AVANVOMERE TIPO ERMO A29 - CA105AD - CA105AS	1
56825	56717	VOMERE PER AVANVOMERE TIPO ERMO A30 - CA106AD - CA106AS	1
56826	56718	VOMERE TIPO ERMO A22 D - CA093AD - CA093AS	2
56827	56828	VOMERE TIPO ERMO A22 B - CA094AD - CA094AS	2
56829	56719	VOMERE TIPO ERMO GS 8 - 2 fori - CA031AD - CA031AS	2
56830	56720	VOMERE TIPO ERMO GS 9 - 3 fori - CA033AD - CA033AS	2
56831	56721	VOMERE TIPO ERMO GS 8B - 3 fori - CA032AD - CA032AS	2
56833	56723	LAMINO REVERSIBILE TIPO ERMO GS 10 - GS 11 - CA003AD - CA003AS	3
56834	56724	LAMINO TIPO ERMO B 55	3
56835	56725	LAMINO TIPO ERMO SENZA COLTRE B 57 - CA001AD - CA001AS	3
56836	56726	LAMINO TIPO ERMO CON COLTRE B 58 - CA002AD - CA002AS	3
56839	56727	SUPPORTO TIPO ERMO GS 2 - CA016AD - CA016AS	4
56840	56728	PREVERSOIO TIPO ERMO A 32 - SD002AD - SD002AS	5
56841	56729	VERSOIO TIPO ERMO 2 ME	6
56842	56730	ALETTA PER AVANVOMERE TIPO ERMO A26 GRANDE - CA053AD - CA053AS	7
56843	56731	ALETTA PER AVANVOMERE TIPO ERMO A26T PICCOLA - CA055AD - CA055AS	7
56844	56732	ALETTA PER AVANVOMERE TIPO ERMO A28 GRANDE - CA054AD - CA054AS	7
56845	56733	ALETTA PER AVANVOMERE TIPO ERMO A28T PICCOLA - CA056AD - CA056AS	7
56846	56734	PIASTRA LATERALE TIPO ERMO A39	8
56847	56735	PIASTRA LATERALE TIPO ERMO A40	8
56848	56736	PIASTRA LATERALE TIPO ERMO C10 - CA073AD - CA073AS	8
56849	56850	PIASTRA LATERALE TIPO ERMO C10 M - CA074AD - CA074AS	8
56851	56737	PIASTRA LATERALE TIPO ERMO C11 - CA075AD - CA075AS	8
56852	56853	PIASTRA LATERALE TIPO ERMO C12 - CA076AD - CA076AS	8
56854	56738	PIASTRA TIPO ERMO A36 - CA071AD - CA071AS	8
56855	56739	PIASTRA TIPO ERMO B63 - CA072AD - CA072AS	8
56837	56838	SQUADRETTA LATERALE TIPO ERMO SQ2	-

Ricambi per Aratri

EXCHANGES FOR PLOUGHS

03

segue **RICAMBI PER ARATRI**
 RECHANGES POUR CHARRUES - EXCHANGES FOR PLOUGHS - ERSATZTEILEN FUER PFLUGE - RECAMBIOS PARA ARADOS

VOMERI - KUHN

SOC - KUHN
 SHARE - KUHN
 SCHARE - KUHN
 REJAS - KUHN

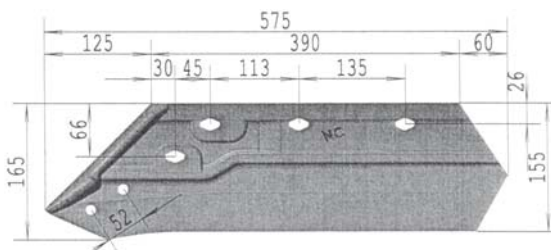

Il disegno rappresenta il particolare DX

ARTICOLO	DESCRIZIONE	OEM
57339	Vomere Destro	622134
57340	Vomere Sinistro	622135

VOMERI - KUHN

SOC - KUHN
 SHARE - KUHN
 SCHARE - KUHN
 REJAS - KUHN

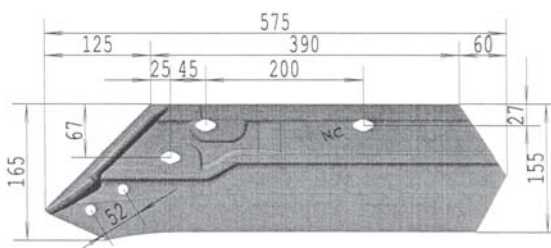

Il disegno rappresenta il particolare DX

ARTICOLO	DESCRIZIONE	OEM
57345	Vomere Destro	622140
57346	Vomere Sinistro	622141

VOMERINI - KUHN

SOCs DE RASLETTE - KUHN
 SKIM POINTS - KUHN
 DUNGEREINLEGGERSCHARE - KUHN
 REJAS - KUHN



ARTICOLO	DESCRIZIONE	OEM
57349	Vomerino Destro	631102
57350	Vomerino Sinistro	631103
57351	Vomerino Destro/Sinistro	631104
57352	Vomerino Destro	631108
57353	Vomerino Sinistro	631109

VOMERI - KUHN

SOC - KUHN
 SHARE - KUHN
 SCHARE - KUHN
 REJAS - KUHN

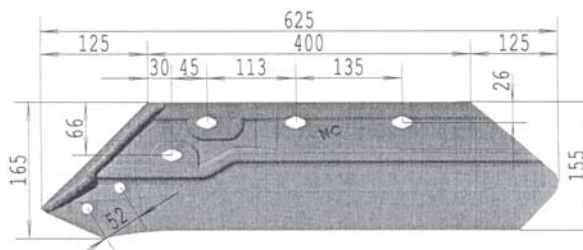

Il disegno rappresenta il particolare DX

ARTICOLO	DESCRIZIONE	OEM
57343	Vomere Destro	622136
57344	Vomere Sinistro	622137

VOMERI - KUHN

SOC - KUHN
 SHARE - KUHN
 SCHARE - KUHN
 REJAS - KUHN

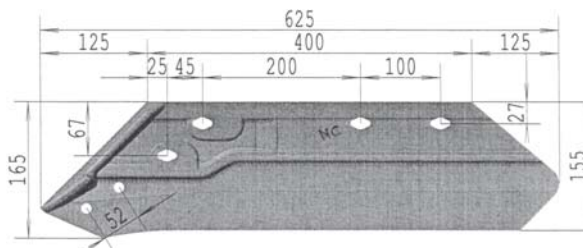

Il disegno rappresenta il particolare DX

ARTICOLO	DESCRIZIONE	OEM
57347	Vomere Destro	622142
57348	Vomere Sinistro	622143

PUNTA PER VOMERE - KUHN

POINTE POUR SOC - KUHN
 SHARE TIPS - KUHN
 SCHARSPITZEN - KUHN
 REJAS - KUHN

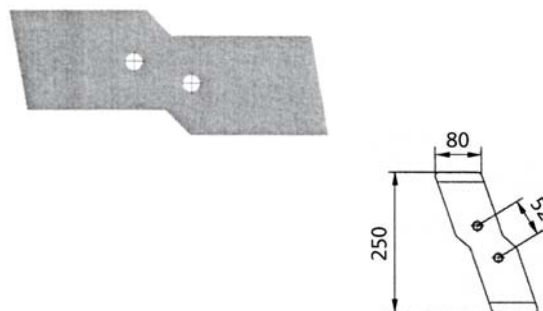

ARTICOLO	DESCRIZIONE	OEM
57341	Punta per Vomere Destra	622128
57342	Punta per Vomere Sinistra	622129

segue RICAMBI PER ARATRI

RECHANGES POUR CHARRUES - EXCHANGES FOR PLOUGHS - ERSATZTEILEN FUER PFLUGE - RECAMBIOS PARA ARADOS

PUNTE PER VOMERE - LEMKEN

POINTE POUR SOC - LEMKEN
SHARE TIPS - LEMKEN
SCHARSPITZEN - LEMKEN
REJAS - LEMKEN

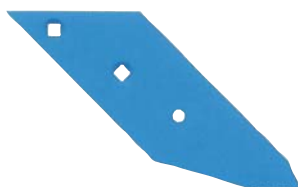

ARTICOLO	DESCRIZIONE	OEM
57326	Punta per vomere Destra Tipo B2S	3364150
57327	Punta per vomere Sinistra Tipo B2S	3364151

VOMERI - LEMKEN

SOC - LEMKEN
SHARE - LEMKEN
SCHARE - LEMKEN
REJAS - LEMKEN

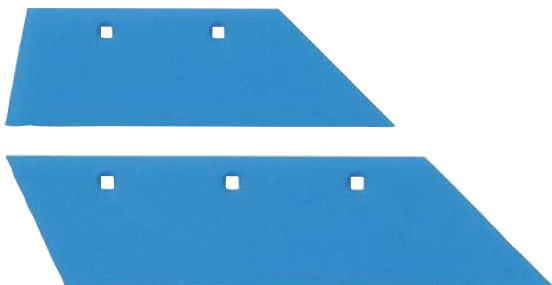

ARTICOLO	DESCRIZIONE	SPESSORE mm	NR. FORI	OEM
57328	Vomere Destro Tipo SB45	10	2	3352030
57329	Vomere Sinistro Tipo SB45	10	2	3352031
57330	Vomere Destro Tipo SB45D	12	2	3352130
57331	Vomere Sinistro Tipo SB45D	12	2	3352131
57332	Vomere Destro Tipo SB56	10	3	3352034
57333	Vomere Sinistro Tipo SB56	10	3	3352035
57334	Vomere Destro Tipo SB56D	11	3	3352134
57335	Vomere Sinistro Tipo SB56D	11	3	3352135

VOMERINI - LEMKEN

SOCS DE RASLETTE - LEMKEN
SKIM POINTS - LEMKEN
DUNGEREINLEGERSCHARE - LEMKEN
REJAS - LEMKEN



ARTICOLO	DESCRIZIONE	OEM
57336	Vomerino Destro Tipo S270	3363710
57337	Vomerino Sinistro Tipo S270	3363711
57338	Vomerino Destro/Sinistro Tipo S360 - 08mm	3363724

segue **RICAMBI PER ARATRI**
 RECHANGES POUR CHARRUES - EXCHANGES FOR PLOUGHS - ERSATZTEILEN FUER PFLUGE - RECAMBIOS PARA ARADOS

VOMERI - MORO ARATRI

SOC - MORO ARATRI
 SHARE - MORO ARATRI
 SCHARE - MORO ARATRI
 REJAS - MORO ARATRI

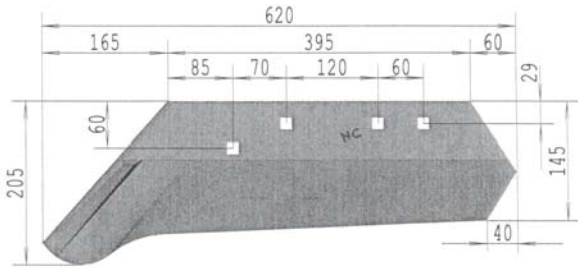

Il disegno rappresenta il particolare DX

ARTICOLO	DESCRIZIONE	OEM
57358	Vomere Destro	A5
57359	Vomere Sinistro	A5

VOMERI - MORO ARATRI

SOC - MORO ARATRI
 SHARE - MORO ARATRI
 SCHARE - MORO ARATRI
 REJAS - MORO ARATRI

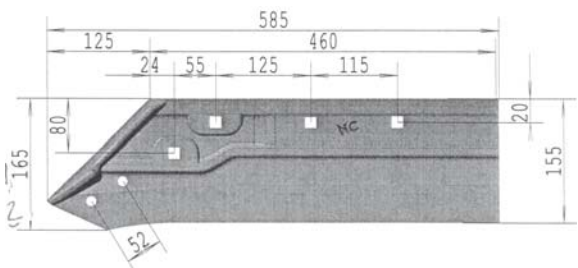

Il disegno rappresenta il particolare DX

ARTICOLO	DESCRIZIONE	OEM
57362	Vomere Destro	A7-2° 26044
57363	Vomere Sinistro	A7-2° 26045

PUNTA PER VOMERE - MORO ARATRI

POINTE POUR SOC - MORO ARATRI
 SHARE TIPS - MORO ARATRI
 SCHARSPITZEN - MORO ARATRI
 REJAS - MORO ARATRI

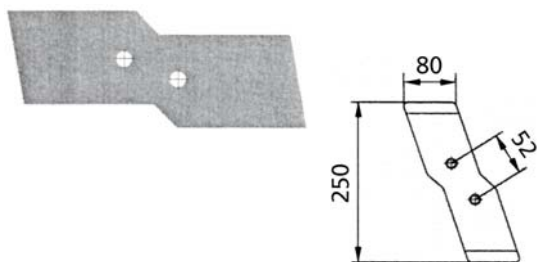

ARTICOLO	DESCRIZIONE	OEM
57341	Punta per Vomere Destra	622128
57342	Punta per Vomere Sinistra	622129

VOMERI - MORO ARATRI

SOC - MORO ARATRI
 SHARE - MORO ARATRI
 SCHARE - MORO ARATRI
 REJAS - MORO ARATRI

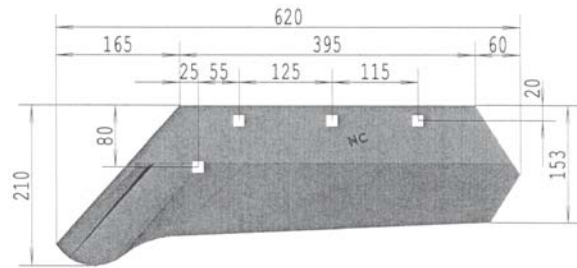

Il disegno rappresenta il particolare DX

ARTICOLO	DESCRIZIONE	OEM
57360	Vomere Destro	A7
57361	Vomere Sinistro	A7

VOMERINI - MORO ARATRI

SOCS DE RASETTE - MORO ARATRI
 SKIM POINTS - MORO ARATRI
 DUNGEREINLEGERSCHARE - MORO ARATRI
 REJAS - MORO ARATRI

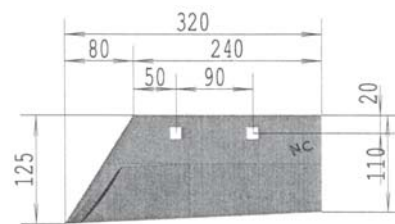

Il disegno rappresenta il particolare DX

ARTICOLO	DESCRIZIONE	OEM
57364	Vomerino Destro	30020
57365	Vomerino Sinistro	30021

segue RICAMBI PER ARATRI

RECHANGES POUR CHARRUES - EXCHANGES FOR PLOUGHS - ERSATZTEILEN FUER PFLUGE - RECAMBIOS PARA ARADOS

VOMERI - MORO PIETRO

SOC - MORO PIETRO
SHARE - MORO PIETRO
SCHARE - MORO PIETRO
REJAS - MORO PIETRO

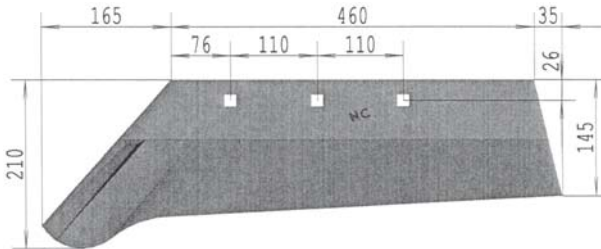

Il disegno rappresenta il particolare DX

ARTICOLO	DESCRIZIONE	OEM
57366	Vomere Destro	-
57367	Vomere Sinistro	-

VOMERINI - MORO PIETRO

SOCS DE RASLETTE - MORO PIETRO
SKIM POINTS - MORO PIETRO
DUNGEREINLEGGERSCHARE - MORO PIETRO
REJAS - MORO PIETRO

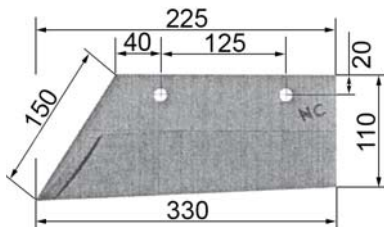

Il disegno rappresenta il particolare DX

ARTICOLO	DESCRIZIONE	FORO SVASATO
57370	Vomerino Destro	25±13
57371	Vomerino Sinistro	25±13

VOMERI - MORO PIETRO

SOC - MORO PIETRO
SHARE - MORO PIETRO
SCHARE - MORO PIETRO
REJAS - MORO PIETRO

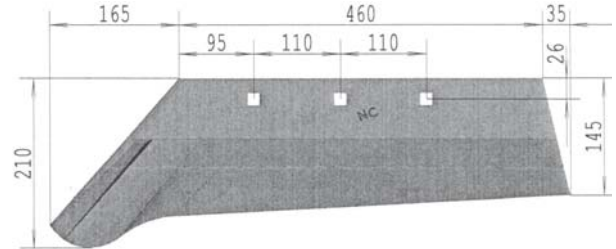

Il disegno rappresenta il particolare DX

ARTICOLO	DESCRIZIONE	OEM
57368	Vomere Destro	UN400
57369	Vomere Sinistro	UN400L

VOMERINI - MORO PIETRO

SOCS DE RASLETTE - MORO PIETRO
SKIM POINTS - MORO PIETRO
DUNGEREINLEGGERSCHARE - MORO PIETRO
REJAS - MORO PIETRO

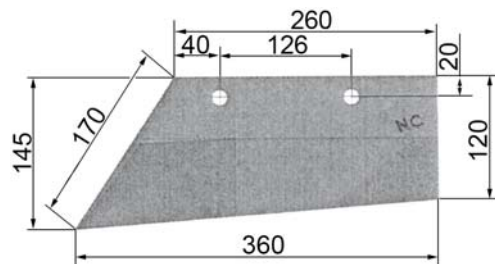

Il disegno rappresenta il particolare DX

ARTICOLO	DESCRIZIONE	FORO SVASATO
57372	Vomerino Destro	25±14
57373	Vomerino Sinistro	25±14

Ricambi per Aratri

EXCHANGES FOR PLOUGHS

03

03

segue RICAMBI PER ARATRI

RECHANGES POUR CHARRUES - EXCHANGES FOR PLOUGHS - ERSATZTEILEN FUER PFLUGE - RECAMBIOS PARA ARADOS

VOMERI IN ACCIAIO AL SILICIO per corpi a scalpello, forati e verniciati NARDI

SOCS EN ACIER AU SILICE pour corps de rasette, percés et peints NARDI
 SILICON STEEL SHARES for NARDI perforated and painted chisel-share implements
 SCHARE AUS SILIZIUMSTAHL für Meißelkörper, gelocht und lackiert NARDI
 REJAS DE ACERO AL SILICIO para cuerpos de cincel, perforadas y pintadas NARDI



ARTICOLO	LATO	ATTREZZI SUI QUALI VENGONO MONTATI	OEM NARDI
56002	Dx	HR32 - 33 — QL 38/F - PRRP 48 — TR 20-21-30-31 — TRR 30-31 — QR 20-21-30-31 — QRR 30-31 — PR 20-21-30-31 — PRR 30-31 — VR 20-21-32-33 — VRR 32-33 - VM 30 — QM 30	1C43
56003	Sx	— 5-7 HR 32-33 — 5-7 HRR 32-33 — 2 VR 32 CF — 3 AS 50 — M 7 — Z 7 — A 20 — BP 13 — TR 13 — VR 13 — BR 13 — BPH 17 — TR 15 — 3 VR 15 - NVR 70 x 40	1CS43
56004	Dx	35 MRCU/A — 45-50 MRCU — 0 MRCAUG — 35 MRCUS/A — 45-50 MRCUS — 50 BRRCU/A — 55 BRCU/A — 60-65 BRCUA — 70 BRCU — 1 BRCAUG/F — 75 BRRCO — 45-50 ZRCU — 45-50 ZRCUI — 130 BTRRCO — 2 BRAUG/F	9C53 (3 fori)
56158	Sx	1-2 BT/G-GI — 1-2 TQR/F-FI — MRCPL 48 - 50-55-65 MRPS — MPSC 60-70 — 60 MZ/E — 60 MZS — 80-81-90-91 MZ/C — 80-90 MZS/A — BRCP 80 — 95-100 BRPS/A — 100 BZ/E — 110 BZS — 110 BZS — 115 BDF — 120-121-130-131 BZ/D — 125 BZF — 130 BZS — 135 BDF — 180-181 BTZ/A — 180-181 BTZ/A — 130 TZ/E — 180 QTZ/E — MCP 48/H — MRCP 48/H — MRCP 47 — BCP 70/H — BRCP 68-70/H — BRCP 90/A — BRP 110/A — BTRP 100/A-110/A-160/A	9CS53 (3 fori)
56008	Dx	55 MRCU — 60 MRCUA — 1 MCUAG/F — MRPL 80 — 70 MRPS — 95 MPS/A — 100 MZ/C — 110 MZS — 115 MDF — 120 MZ/D — 125 MZ/D — 135 BRPS/A — 140 BZ/D — 180 BZ/A — MCP 58-70/H — MRCP 58-70/H — BTS 120 — BTSG 150	13C53
56009	Sx		13CS53
56010	DX	Carrellati: 3 MRAUG - 100 MRRCO/B - 80 MRRCO/B - 90 MRRCO/B Trainati: 70 DMR - 70 DMR/I 1 - 70 DMR/I 2 - 80 DMR - 80 DMR/I 1 - 80 DMR/I 2 - 4 BTR/H - 4 BTR/BI 1 - 4 BTR/F - 4 BTR/G - 4 BTR/FI - 4 BTR/GI - 4 BTR/BI 2 - 4 BTR/BI 3 - 5 BTR/G - 5 BTR/GI 1 - 5 BTR/GI 2 - 5 BTR/GI 3 - 6 BTR/B - 6 BTR/BI 1 - 6 BTR/GI 2 Portati: 150 MRPS/A - MRP 10Q/K - MRP 130/K MRP 160/B - MRP 160/A	16C53
56011	Dx	35 BTRCU/A - BRP 26/V - BRCP 28/A - 35 BRPS/A - BPSC 28/30/A - 40 BZ/E - 60 BTZ/E - BTRCPL 38-48/A - BP 28/H - BRCP 28/H - 'BTP 28.G - BTRCP 28/H - TQRCP 48/H - DAP 18/A - TQPR 60/C - TQRT 60L	5C54
56012	Sx		5CS54
56013	Dx	35 BRCU/A — 35 BRCUS/A — 45-50 BTRCU/A — 0 BTCAUG — 1 BTCAUG/F - 00 BT/F-G — 00 BT/FI-GI — MCPL 15 — MCP2L 18 — BPG 50 — MPSC 28/A — BRCP 38/A — 40 BRPS/A — BPSC 50 — ZCPL 28 — MCP 18/A — BP 38/H — BP 38G — BRCP 38/H — BRCP 39/H — BTRCP 48/H - TQRCP 70/H — DAP 28/A — ZAP 35	6C54
56014	Sx		6CS54
56015	Dx	30 MRCU/A — 30 MRCUS/A — 30-45-50 BRCU/A — 0 BCAUG/A — 0 BRAUG/A — 30-45-50 BRCUS/A — 2 BTCAUG/F — 30 ZRCU — 35 ZRACU — 35 ZRACUI — 0 BT/F-G — 0 BT/FI-GI — 0 BTR/F-G — 0 BTR/FI-GI — 0 TQR/F-FI — MCPL 28 — MRCPL 28-38/A — MPG 50 — 35-40 MRPS/A — MPSC 30/A — 40 MZ/E — BRCP 48/A — 50-70 BRPS/A — BPSC 50-60 — BPSC 70/A — 50-60-80-90 BZ/E — 60 BZS — 80-90 BZS/A — 90 BTZ/E — 100 BTZ — 110 BTZS — BTRCPL 80 — 120 TZ/E — 120-130 QTZ/E — ZCPL 38-48 — MCP 38/H — MP 46/H — MRCP 28-38/H — BP 48-58/H — BRCP 48-58/H — BTP 38G — BTRCP 52-70-80/H — TQRT 80-150/C — QPRT 130-140-150/C — PERT 130/C — TQRT 90/C — QPS 140 U/A — PES 140 U/A — DAP 38-48/A — ZAP 45-60 — EEP 130.FS — TQS 150 — PESS 150 — BTP 60.SI — TQP 80-90.SI	7C54
56016	Sx		7CS54
56017	—	65 MRCUA — 70 MRCU — 2 MARAUG/F — 70 MRRCO/B — 3 BRRAUG/A — 80-90-100 BRRCO/B — 21/2-3-4 BT/F-G — 21/2-3-4 BT/FI-GI — 4 BTP — 4 BTP/I — 3 BTR/F-G — 3 BTR/FI-GI — 3-4-41/2 TQR/F-FI — 150 BRPS/B — MRP 90/H — BRP 120/K — BRP 160/A — MS 120	12C54

segue RICAMBI PER ARATRI

RECHANGES POUR CHARRUES - EXCHANGES FOR PLOUGHS - ERSATZTEILEN FUER PFLUGE - RECAMBIOS PARA ARADOS

VOMERINE IN ACCIAIO AL CARBONIO forate e verniciate NARDI

SOCS EN ACIER AU CARBONE percés et peints NARDI
 CARBON STEEL SHARES perforated and painted NARDI
 SCHARE AUS NORMSTAHL gelocht und lackiert NARDI
 REJAS DE ACERO AL CARBONO perforadas y pintadas NARDI

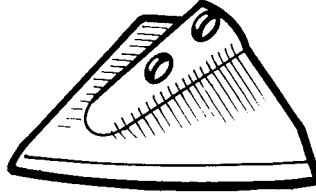

ARTICOLO	LATO	ATTREZZI SUI QUALI VENGONO MONTATI	OEM NARDI
56018	-	5-7-9 TM — 11-13 TM/A — 7-11-13-15 TMR/A — 9 TMR	2C430

SCALPELLI IN ACCIAIO BORO-CARBONIO forati e verniciati NARDI

POINTES EN ACIER BORE-CARBONE percées et peintes NARDI
 CHISEL-SHARES IN BORON-CARBON STEEL perforated and painted NARDI
 MEISSEL AUS BOR-KOHLSTOFFSTAHL gelocht und lackiert NARDI
 CINCELES DE ACERO BORO-CARBONO perforadas y pintadas NARDI

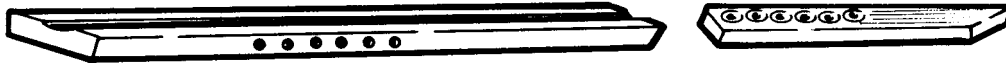

ARTICOLO	LATO	ATTREZZI SUI QUALI VENGONO MONTATI	OEM NARDI
56019 (30x32)	Dx	30 BRCU/A — 30 BRUCUS/A — 35 BTRCU/A — BRP 26/V — BRCPL 28/A — 35 BRPS/A — BPSC 28-30/A — 40-50 BZ/B — 60-90 BTZ/E — BTRCPL 38-48/A — 120 QTZ/E - BP 28/H — BRCP 28/H — BTP 28-38G — BTRCP 28/H — TQRCP 48/H — TQRT 80/C — QPRT 130/C — PER 130/C — DAP 18/A — TQPRT 60/C — TQRT 60L — EEP 130FS - BTP 60 SI — TQP 80 SI	5C63
56020 (30x32)	Sx		5CS63
56021 (40x25)	Dx	30 BTRCU — BRVP2L 18 — BVCPL 15 — BTRCPL 28 — BRP 21 — BTRCP 18-28 — QL 38/F PRRP 48 — BRVP 18 — TR 30-31 — TRR 30-31 — QR 30-31 — QRR 30-31 — PR 30-31 PRR 30-31 — VR 32-33 — VRR 32-33 — VM 30 — QM 30 — 5-7 HRR 32-33 — 2 VR 32 CF — 3 AR 30 — BP 13 — BPH 17 - BPS 20 — BPK 35 — BPSC 22	2C62
56022 (40x25)	Sx		2CS62
56023 (35x35)	Dx	30 MRCU/A — 30 MRCUS/A — 35-45 BRCU/A — 50 BRCU/A — 0 BCAUG/A — 0 BRAUG/A — 35-45 BRCUS/A — 50 BRCUS/A — 45-50 BTRCU/A — 0 BTCUAG — 1-2 BTCAUG/F — 30 ZRCU — 35 ZRA-CU — 35 ZRACUI — 0 BTR/F-G — 0 BTR/FI-GI — 00-0 BT/F-G — 00-0 BT/FI-GI — 0 TQR/F-FI — MCPL 15 — MCP2L 18 — MCPL 28 — MRCPL 28-38/A — MRCPL 38-48/A — 35-40 MRPS/A — MPSC 28-30/A — MPG 50 — BPG 50 — MPSC 50 — 40 MZ/E — BRCPL 38-48/A — 40-50-70 BRPS/A — BPSC 50-60 — BPSC 70/A — 60-80-90 BZ/E - 60 BZS — 80-90 BZS/A — 100 BTZ — 110 BTZS — BTRCPL 80/A — 120 TZ/E — 130 QTZ/E — ZCPL 28-38-48 — MCP 18/A — MCP 38/H — MP 46/H — MRCPL 38-38/H - BP 38-48-58/H — BP 38/G — BRCP 38-39-48-58/H — BTRCP 48-52-70-80/A — TQRCP 70/H — TQRT 150/C — QPRT 140/C - QPRT 150/C - TQRT 90/C — QPS 140 S/A — PES 140 U/A — DAP 28-38-48/A — ZAP 35-45-60 — TQS 150 — PESS 150 — TQP 90 SI	6C64
56024 (35x35)	Sx		6CS64
56025 (40x40)	Dx	35 MRCU/A — 45-50 MRCU — 0 MRCAUG — 35 MRCUS/A — 45-50 MRCUS — 50 BRRCU/A — 55 BRCU/A — 60-65 BRCUA — 1 BRCUAG/F — 45-50 ZRCU — 45-50 ZRCUI — 1 BT/F-G — 1 BT/FI-GI — 1 TQR/F-FI — MRCPL 48 — 50-55-65 MRPS — MPSC 60-70 — 60 MZ/E — 60 MZS — 80-90 MZ/C - 80-90 MZS/A — BRCPL 80 — 95-100 BRPS/A — 100 BZE — 110 BZS — 115 BDF — 120-130 BZ/D — 125 BZ/F — 130 BZS — 135 BDF — 180 BTZ/A — 130 TZ/E — 180 QTZ/E — MCP 48/H — MRCP 47 — MRCP 48/H — BCP 70/H — BRCP 68-70/H — BRCP 90/A — BRTP 100/A — BTRP 110/A — BTS 100	9C63
56026 (40x40)	Sx		9CS63
56027 (45x45)	Dx	55 MRCU — 60 MRCUA — 1 MCUAG/F — 70 BRCU — 2 BRAUG/F — 75 BRRCO — 130 BTRRCO — 2BT/F-G — 2 BT/FI-GI — 2 TQR/F-FI — MRPL 80 — 70 MRPS — 95 MPS/A — 81-91-100 MZ/C — 110 MZS — 115 MDF — 120 MZ/D - 125 MZ-D — 135 BRPS/A — 121-131-140 BZ-D — 180 BZ-A — 181 BTZ/A — MCP 58/70/H — MRCP 58-70/H — BRP 110/A — BTRP 160/A — BTS 120	11C63
56028 (45x45)	Sx		11CS63
56029 (50x50)	Dx	65 MRCUA — 70 MRCU — 2 MRAUG/F — 70 MRRCO/B — 3 BRRAUG/A — 80-90-100 BRRCO/B — 21/2-3-4 BT/F-G — 21/2-3-4 BT/FI-GI — 4 BTP — 4 BTPI — 3 BTR/F-G — 3 BTR/FI-GI — 3-4-41/2-TQR/F-FI — 150 BRPS/B — MRP 90/H — BRP 120/K — BRP 160/A — MS 120 — MRP 100/K	12C63
56856 (50x50)	Sx		12CS63
56030 (55x55)	-	3 MRAUG — 80-90 MRRCO/B — 70 DMR — 70 DMR/I — 4 BTR/F-G — 4 BTR/FI-GI — 150 MRPS/A — MRP 130/K	17C63

Ricambi per Aratri

EXCHANGES FOR PLOUGHS

03

03

segue RICAMBI PER ARATRI

RECHANGES POUR CHARRUES - EXCHANGES FOR PLOUGHS - ERSATZTEILEN FUER PFLUGE - RECAMBIOS PARA ARADOS

SUPPORTI SCALPELLO IN ACCIAIO AL CARBONIO forati e verniciati NARDI

SUPPORTS POINTE EN ACIER AU CARBONE percés et peints NARDI
CHISEL-SHARES IN BORON-CARBON STEEL perforated and painted NARDI
MEISSELTRÄGER AUS NORMSTAHL gelocht und lackiert NARDI
SOPORTES CINCEL DE ACERO AL CARBONO perforados y pintados NARDI

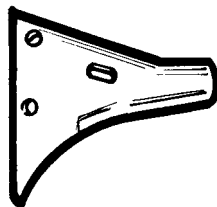

ARTICOLO	LATO	ATTREZZI SUI QUALI VENGONO MONTATI	OEM NARDI
56031	Dx	carrellati - 30 BRCU/A — 30 BRCUS/A — 35 BTRCU/A portati - BRP 26V — BRCPL 28/A — 35 BRPS/A — BPSC 28/30/A — 40-50 BZ/E — 60-90 BTZ/E — BTRCPL 38-48/A — 120 QTZ/E — BP 28/H — BRCP 28/H — BTP 28-38G — TQPRT 60/C — TQRT 60L - EEP 130.FS — BTP 60.SI — TQP 80.SI — BTRCP 28/H — TQRCP 48/H — TQRT 80/C — QPRT 130/C — PERT 130/C — DAP 185A	5C83
56032	Sx		5CS83
56033	Dx	35-45 BRCU/A — 0 BCAUG/A — 35-45 BRCUS/A — 45-50 BTRCU/A — 0 BTCAUG - 1 BTCAUG/F — 30 ZRCU — 00.0 BT/F-G — 00 BT/FI-GI — 0 TQR/F-FI — MCPL 15 — MCP2L 18 — MCPL 28 — MRCPL 28/A — BPG 50 — 35 MRPS/A — MPSC 28-30/A — 40 MZ/E — BRCPL 38/A — PRCL 38/48/A — BRCPL 48/A — 40-50 BRPS/A — BPSC 50-60 — 60-80 BZ/E — 100 QTZ/E — ZCPL 28-38 — MCP 18/A — MRCP 28/H — BP 38-48/H — BP 38G — BRCP 38-39-48/H — BTRCP 48-52-70/H — TQRCP 70/H — QPRT 140/C — TQRT 90/C — QPS 140 U/A — PES 140 U/A — DAP 28-38/A — ZAP 35-45 — TQP 90.SI	6C83
56034	Sx		6CS83
56035	Dx	30 MRCU/A — 30 MRCUS/A — 50 BRCU/A — 0 BRAUG/A — 50 BRCUS/A — 2BTCAUG/F — 35 ZRACU — 35 ZRACUI — 0 BTR/F-G — 0 BTR/FI-GI — MRCPL 38A — MPG 50 — 40 MRPS/A — 70 BRPS/A — BPSC 50 — BPSC 70/A — 90 BZ/E — BTRCPL 80 — 120 TZ/E — ZCPL 48 — MCP 38/H — MP 46/H - MRCP 38/H — BP 58/H — BRCP 58/H — BTRCP 80/H — TQRT 150/C — QPRT 150/C — DAP 48/A — ZAP 60 — TQS 150 — PESS 150	8C83
56036	Sx		8CS83
56037	Dx	35 MRCU/A — 45-50 MRCU — 0 MRCAUG — 35 MRCUS/A — 45-50 MRCUS — 50 BRRCU/A — 55 BRCU/A — 60-65 BRCUA — 1 BRACAUG/F — 45-50 ZRCU — 45-50 ZRCUI — 1 BT/F-G — 1 BT/FI-GI — 1 TQR/F-FI — MRCPL 48 — 50-55-65 MRPS — MPSC 60-70 — 60 MZ/E — 80-90 MZ/C — BRCPL 80 — 95-100 BRPS/A — 100 BZ/E — 120-130 BZ/D — 125 BZ/F — 180 BTZ/A — 130 TZ/E — 180 QTZ/E — MCP 48/H — MRCP 47 — MRCP 48/H — BCP 70/H — BRP 68-70/H — BRCP 90/A — BRTP 100-110/A — BS 100	9C83
56038	Sx		9CS83
56039	Dx	70 BRCU — 2 BRAUG/F — 75 BRRCO — BT/F-G — 2 BT/FI-GI — 2 TQR/F-FI — 81-91 MZ — 121-131 BZ/D — 181 BTZ/A — BRP 110/A — BTRP 160/A	11C83
56040	Dx	55 MRCU — 60 MRCUA — 1 MCAUG/F — MRPL 80 — 70 MRPS — 95 MPS/A — 100 MZ/C — 120 MZ/D — 125 MZ/D — 135 BRPS/A — 140 BZ/D — 180 BZ/A — MCP 58-70/H — BTS 120 — MRCP 58-70/H	12C83
56041	Dx	65 MRCUA — 70 MRCU — 2 MRAUG/F — 70 MRRCO/B — 3 BRRUAUG/A — 75 BRRCO — 80-90-100 BRRCO/B — 130 BTRRCO — 21/2 BT/F-G — 21/2-3-4 BT/FI-GI — 4 BTP — 4 BTP/I — 3 BTR/F-G — 3 BTR/FI-GI — 3-4-41/2 TQR/F-FI — 150 BRPS/B — MRP 90 — MRP 100/K — BRP 120/K — BRP 160/A — MS 120	13C83

segue RICAMBI PER ARATRI

RECHANGES POUR CHARRUES - EXCHANGES FOR PLOUGHS - ERSATZTEILEN FUER PFLUGE - RECAMBIOS PARA ARADOS

TALLONI IN ACCIAIO AL SILICIO NARDI

TALONS EN ACIER AU SILICIUM NARDI
NARDI HEEL CASTINGS IN SILICON STEEL
ANLAGEN AUS SILIZIUMSTAHL NARDI
TALONES DE ACERO AL SILICIO NARDI



ARTICOLO	LATO	ATTREZZI SUI QUALI VENGONO MONTATI	OEM NARDI
56042	Dx	carrellati: 30-35 MRCU/A — 45-50-55-70 MRCU — 60 MRCUA - 0 MRCAUG — 70 MRRCO/B — 30-35 MRCUS/A — 45-50 MRCUS — 30-35-45-50-55-70 BRCU/A — 50 BRRCO/A — 60-65 BRCUA — 0 BCAUG/A — 0 BRAUG/A — 1 BRACAUG/F — 2 BRAUG/F — 80-90-100 BRRCO/B — 30-35-45-50 BRCUS/A — 35-45-50 BTRCU/A — 0 BTAUG — 1-2 BTCAUG./F — 30-35 ZRCU — 45-50 ZRCU — 35 ZRACUI — 45-50 ZRCUI	5C118
56386	Sx	trainati: 0 BTF/F-G — 0 BTF/FI-GI — 00-0-1-2 BT/F-G — 00-1-2 BR/FI-GI — 0-1-2 TQR/F-FI portati: MCPL 15 — MCP2L 18 — MPSC 28-30/A — MPSC 50-60-70 — 150 BRPS/B 28/30 — BPSC 50-60 — 60 BZS — 80-90 BZS/A — 110 BZS — 115 BDF — 60 BTZ/E — 100 BTZ — 120-121-130-131-140 BZ/D — 130 BZS — 135 BDF — 180 BZ/A — 180-181 BTZ/A — 120-130 TZ/E — 120-180 QTZ/E — MRP 90/H — BTP 28G — DAP 18-28-38-48/A — ZAP 35-45 — ZAP 60 — BS 100 — 40-60-80-90-100 BZ/E	5CS118
56043		vecchia produzione: 1-11/2-2-21/2 ZRAU - 0-1 MAU — 0-1 MDAU — 11/2 BLRAU — 0-1-11/2 MRAU — 0-1-11/2 MRAU/SP — 2-3 BAU — 2-21/2-3-4 BRAU — 21/2 BLRAU — 3 TRAU — 0 MAUG — 1-2 BAGU — 3 TAUG — 1 DZM — 2-3 ZB — 2-3 DZMB — 1-2 DBT/A-B — 1-2 BT — 2-3 DTQP — 2QPR — MPL 48 — BP 70/D — MRPL 22-42 — ZPL 45 — 2-3 BDAU	9C113
56044		vecchia produzione: 2 TQR/A-B-C — 2 TQR/CI — BP 70/D — 2-3 BDAU — 21/2-4 BRAU — 1-2 BAUG — 3 TAUG — 2-3 DZMB — 2-3 ZB — 1-2 DBT/A-B — 1-2 BT/A-B-C — 2 DTQ — 2 TQR — 2-3 DTQP — 3 QPR — 2 BTR	9C113A
56045		carrellati: 3BRRAG/A vecchia produzione: 1-2 MAUG — 2 MAU — 2 MDAU — 2 MRAU — 3-5 BAUG — 2-3 DZM — 3 BRAUG — 3 BTR/C — 41/2 TR/A-B-C — 5 TQR — 2 RM/A — 2 RM/AI — 2-31/2-3 BT/A-B-C-D-E — 4 BT/A-B — 2 BTR/A-B-C — 4 BTR/A-B-C — 4 BTR/CI — 3-4 TQR/A-B — 2 DMIG/A-B — 3 DBTR — 4 DTQR — 4 DTQP — 4 RDTQP — 4-5 QPR — 5 DTQP — MPL 50 — MP2 50 — MP 50 — MRPL 50 — MRP2L 50 — MRP 55 — MPP 50-60 — MRPL 50-61 — 3 BT/EI	12C113
56046		carrellati: 3 BRRAG/A trainati: 21/2-3-4 BT/F-G — 21/2-3-4 BT/FI-GI — 4 BTR — 4 BTP/I — 3-4 BTR/F-G — 3-4 BTR/FI-GI — 4-41/2 TQR/F-FI vecchia produzione: 4 BTSP/F-FI — 3 BRAUG — 3 BRRAG — 5 BAUG — 21/2 BTA/A-B-C-D-E — 21/2 BT/EI — 3 BT/A-B-C-D-E — 3 BT/EI — 4 BT/B — 4 BT/BI — 4 BTSP — 5 TQR — 4 BTSP/I — 3 TQR/BI — 4 TQR/B — 4 TQR/BI — 5 DQPR — 3-4 RDTQP — 4-5 DTQP — 41/2 TQR/C	12C113A
56047		carrellati: 65 MRCUA — 1 MCAUG/F — 2 MRAUG/F trainati: 21/2-3-4 BT/F-G — 21/2-3-4 BT/FI-GI — 4 BTP — 4 BTP/I — 3-4 BTR/F-G — 3-4-41/2 TQR/F-FI	12C113L
56048		carrellati: 3MRAUG vecchia produzione: 5MAUG — 3-4 DMIG/A-B — 0 DMRR — 5 DBR — 000 DMR/A-B-C-D-E — 000 DMR/EI — 000-00-00 DMR/2 — 000-00-0 DMR/21 — 000 DMRR/A-B-C-D-E — 000 DMRR/EI — 000 DMRR/EI — 000 DMRR/2 — 000 DMR/2I — 00-0 DMR/A-B-C-D-E-F — 00-0 DMR/FI — 0 DMRR/A-B-C-D-E-F — 0 DMRR/FI — 0 DMRR/2 — 5BTR/B	16C113
56049		carrellati: 80-90 MRRCO/B trainati: 70-80 DMR — 70-80 DMR/I — 5 BTR/F-G — 5BTR/FI-GI — 6 BTR/B — 6 BTR/BI	16C113A

Ricambi per Aratri

EXCHANGES FOR PLOUGHS

03

segue **RICAMBI PER ARATRI**
RECHANGES POUR CHARRUES - EXCHANGES FOR PLOUGHS - ERSATZTEILEN FUER PFLUGE - RECAMBIOS PARA ARADOS

SUOLE IN ACCIAIO AL CARBONIO NARDI

SEMELLES EN ACIER AU CARBONE NARDI
NARDI SHOES IN CARBON STEEL
SOHLEN AUS SILIZIUMSTAHL NARDI
ZAPATAS DE ACERO AL CARBONO NARDI

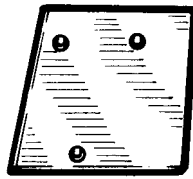

ARTICOLO	LATO	ATTREZZI SUI QUALI VENGONO MONTATI	OEM NARDI
56050	Dx	carrellati: 35 BTRCU/A portati: BRP 26V — BRCPL 28/A — 35 BRPS/A — BPSC 28/30/A — 40 BZ/E — 60 BTZ/E — BTRCPL 38-48/A	5C115
56387	Sx	— BP 28/H — BTP 28G — BRCP 28/H — BTRCP 28/H — TQRCP 48/H — DAP 18/A — TORT 60/C — TQRT 60L	5CS115
56051	Dx	carrellati: 35 TRCU/A portati: BRP 26V — BRCPL 28/A — 35 BRPS/A — BPSC 28/30/A — 40 BZ/E — 60 BTZ/E — BTRCPL	5C115A
56857	Sx	38-48/A — BP 28/H — BTP 28G — BRCP 28/H — BTRCP 28/H — TQRCP 48/H — TQPRT 60/C — TQRT 60L	5CS115A
56052	Dx	carrellati: 35 -45 BRCU/A — 34-35 BRCUS/A — 0 BTCUAG — 1 BTUCAG/F vecchia produzione: 35-45 BRCU — 1BTCUAG — 00 MCAU/I — 00-0-1-11/2 BRCAU — 1 BTCAU	6C115
56388	Sx	— 00-0-1-11/2 BRCAUS/S - 0 TQR/A-B — MPFS 30 — BRPO 38 — 1-11/2-2-21/2 BTRCAU	6CS115
56053	Dx	carrellati: 35 -45 BRCU/A — 0 BCAUG/A — 35-45 BRCUS/A — 45-50 BTRCU/A — 0 BTCAUG — 1 BTCUAG/F trainati: 00-0 BT/F-G — 00-0 BT/FI-GI — 0 TQR/F-FI	6C115A
56858	Sx	portati: BRCPL 38/A — BPG 50 — BRCPL 38/48/A — 40-50 BRPS — BPSC 50-60 — 60-80 BZ/E — 60 BZS/A — 100 BTZ — BP 38G — BP 38-48/H — BRCPP 38-399-48/H — BTRCP 48-52-70/H — TQRCP 70/H — QPRT 140/C — TQRT 90/C — QPS 140 U/A — PES 140 U/A — TPQ 90 SI — BRCPL 48/A	6CS115A
56054	Dx	carrellati: 0 BCUAG/A — 45-50 BTRCU/A — 30 ZRCU trainati: 00-0 BT/F-G — 00-0 BT/FI-GI — 0 TQR/F-FI	6C115L
56859	Sx	portati: MCPL 15 — MCP2L 18 — BPG 50 — 60-80 BZ/E — 60 BZS — 80 BZS/A — 100 BTZ — ZCPL 28-38 — MCP 18/A — MRCP 28/H — BP 38/H — BP 38/G — BP 48/H — BRCP 38-39-48/H — BTRCP 48-52-70/H — TQRCP 70/H — DAP 28-38/A — ZAP 35-45 — TQP 90.SI	6CS115L
57561	Dx	carrellati: 50 BRCU/ A · 0 BRAUG/ A · 50 BRCUS/ A · 2 BTCAUG/F trainati · 0 BTR/F-G · 0 BTR/FI -GI	8C115A
57562	Sx	portati · 70 BRPS/ A · BPSC 70/ A · 90 BZ/ E · 90 BZS/ A · BTRCPL 80/ A · 120 TZ/ E · BP 58/ H · BRCP 58/ H vecchia produzione · 50 BRCU · 0 BRAUG · 2 BTCAUG · 70BRPS · BPSC 70 · 90 BZ · 90 BZ7C · 120 TZ · 120 TZ/ D · BTRCPL 80 · BP 58/ D- F · BRCP 58/ D- F- G · BTRCP 80/ D- F · TQRT 150/ A · QPRT 150/ A · ZBAP 90/ A · 1 1/2 BT/ A- B- C- D- E · 2 LBT · 3 TQR/ A- B · 4 QPR · 2 BTRZ/ A/ B/ C	8CS115A
57563	Dx	carrellati · 30 MRCU/ A · 30 MRCUS/ A · 50 BRCU/ A · 0 BRAUG/ A · 50 BRCUS/ A · 2 BTCAUG/ F trainati · 0 BTR/ F- G · 0 BTR/ FI- GI	8C115
57564	Sx	portati · MPG 50 · 90 BZ/ E · 90 BZS/ A · 120 TZ/ E · MCP 38/ H · MP 46/ H · MRCP 38/ H · BP 58/ H · BRCP 58/ H · BTRCP 80/ H vecchia produzione · 30 MRCU · 50 BRCU · 0 BRAUG · 2 BTCAUG · 90 BZ · 90 BZ/ C · 120 TZ · 120 TZ/ D · MCP 38/ F · MRCP 38/ D- F · BP 58/ DF · BRCP 58/ D- F- G · BTRCP 80/ D- F · ZBAP 90/ A · 00 MRAU · 00 MRAU/ SL · 00 MCAU · 00 MRCAU · 00 MRCAUS/ S · 0 ZRAU · 1 1/2 BRRCAU · 1 1/2 BRRCAU/ S · 0 BTR · MRCP 36 · MPFS 40 · MRPO 38 · MP 38-46 · BRCPL 55 · BRPF 58	8CS115
56055	Dx	carrellati: 35 MRCU/A — 45 MRCU — 0 MRCUAG — 35 MRCUS/A — 45 MRCUS — 50 BRRCU/A — 55 BRCU/A — 60-65 BRCUA — 70 BRCU — 1 BRCAUG/F — 2 BRAUG/ F - 45-50 ZRCU — 45-50 ZRCUI	9C115
56860	Sx	trainati: 1-2 BT/F-G — 1-2 BT/FI-GI — 1-2 TQR/F-FI portati: 100 BZ/E — 110 BZS — 130 TZ/E — 180 QTZ/E — MCP 48/H — MRCP 47 — MRCP 48/H — BCP 70/F — BRCP 68-70/H — BRCP 90/A — BTRP 100-110A	9CS115
57559	Dx	carrellati · 50 BRRCU/ A · 55 BRCU/ A · 60-65 BRCUA · 70 BRCU · 1 BRCAUG/ F · 2 BRCAUG/ F · 75 BRRCO · 130 BTRRCO	9C115L
57560	Sx	trainati · 1-2 BT/ F- G · 1-2 BT/ FI- GI · 1-2 TQR/ F- FI portati · BRCPL 80 · 95-100 BRPS/ A · 100 BZ/ E · 110 BZS · 115 BDF · 120-121-130-131 BZ/ D · 125 BZF · 130 BZS · 135 BDF · 180-181 BTZ/ A · 130 TZ/ E · 180 QTZ/ E · BCP 70/ H · BRCP 68-70/ H · BRCP 90/ A · BRP110/ A · BTRP 100-110-160/ A · BTS 100	9CS115L
56056	Dx	carrellati: 50 BRRCU/A — 55 BRCU/A — 60-65 BRCUA — 70 BRCU — 1 BRCAUG/F — 2 BRCAUG/F — 75 BRRCO — 130 BTRRCO	9C115AL
56861	Sx	trainati: 1-2 BT/F-G — 1-2 BT/FI-GI — 1-2 TQR/F-FI portati: BRCPL 80 — 95-100 BRPS/A — 100 BZ/E — 110 BZS — 115 BDF — 120-121-130-131 BZ/D — 125 BZF — 130 BZS — 135 BDF — 180-181 BTZ/A — 130 TZ/E — 180 QTZ/E — BCP 70/H — BRCP 68-70/H — BRCP 90/A — BRP 110/A — BTRP 100-110-160/A — BTS 100	9CS115AL
57565	-	carrellati · 65 MRCUA · 2 MRAUG/ F · 3 BRRAU/ A trainati · 2 1/2-3 BT/ F- G · 2 1/2 BT/ FI- GI · 3 TQR/ F- FI vecchia produzione · 65 MRCU · 2 MRAUG · 2 MAUG · 3 BRAUG · 3 BRRAU/ G · 2 1/2 BT/ A- B- C- D- E · 2 1/2 LBT · 3 TQR/ A- B · 4 QPR · 2 BTRZ/ A- B- C	12C143
56058	-	trainati: 4BT/F-G — 4 BT/FI-GI — 4 BTP — 4 BTP/I — 3 BTR/G — 3 BTR/GI — 4-41/2-5 TQR/F-FI vecchia produzione: 3 MRAU — 5 QPR — 4 BT/A-B — 3 BTR/A-B-F — 4 BTSP	15C143

segue RICAMBI PER ARATRI

RECHANGES POUR CHARRUES - EXCHANGES FOR PLOUGHS - ERSATZTEILEN FUER PFLUGE - RECAMBIOS PARA ARADOS

VERSOI NARDI
 VERSOIRS NARDI
 NARDI MOLDBOARDS
 STREICHBLECHE NARDI
 VERTEDERAS NARDI

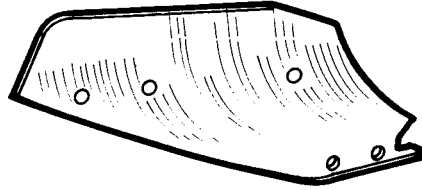

ARTICOLO	LATO	ATTREZZI SUI QUALI VENGONO MONTATI	OEM NARDI
56115	Dx	portati: QL 38/F — PRRP 48 attrezzature da vigneto: TR 21-30 — TRR 30 — QR 21-30 — QRR 30 — PR 21-30 — PRR 30 — VR 21 — QM 30 — VM 30	2C173B
56116	Sx	vecchia produzione: O PER — 1 ETR — VC 30 — TR 40 — VR 40 — VR 30 — HR 30 — VRR 30 — HRR 30 — PRP 48 — VR 10-16	2CS173B
56119	Dx	carrellati: 35 BTRCU/A portati: BRP 25/V — BRCPL 28/A — 35 BRPS/A — BPSC 28/30/A — 40 BZE — 60 BTZ/E — BTRCPL 38-48/A — BP 28/H — BTP 28G — BRCP 28/H — BTRCP 28/H — TQRCP 48/H — DAP 18/A TQRT 60L — TQPT 60/C	5C163B
56120	Sx	vecchia produzione: 35 BTRCU — BRCPL 28 — 35 BRPS — BPSC 28-30 — 40 BZ — 60 BTZ — BTRCPL 38-48 — BP 28/D-F — BRCP 28/D-F-G — BTRCP 28/D-F — TQRCP 48/D-F — TQPT 60 — DAP 18 — ZBAP 39 — 00 BTRCAU — 00 BTRCAU — 00 BTRCAU/S — 0 BTCAU — BPFS 30 — BRPS 28 — Z14 — BLCP 28 — BTRCP 28-38/D	5CS163B
56121	Dx	carrellati: 35 BRCU/A — 35 BRCUS/A — 45-50 BTRCU/A — 0 BTCUAG — 1 BTCAUG/D trainati: 00 BT/F-G — 00 BT/FI-GI portati: MCPL 15 — MCP2L 18 — MPSC 28/A — BRCP 38/A — 40 BRPS/A — BPG 50 — BPSC 50 — ZCPL 28 — MCP 18/A — BP 28/H — BP 28G — BRCP 38-39/H — BTRCP 48/H — TQRCP 70/H — DAP 28/A — ZAP 35	6C163B
56122	Sx	vecchia produzione: 35 BRCU — 45-50 BTRCU — 1 BTCUAG — MPSC 28 — BRCPL 38 — 40 BRPS — BPSC 38 — MCP 18 — BP 38/D-F — BRCP 38-39/A-D-F-G — BTRCP 48/D-E-F — TQRCP 70/D — DAP 28 — 00 MAU — 00-0 BRAU — 00-0 BRAU/SL — 1 TRAU — 0 BTAUG — 1 TAUG — 00-0 BRCAU — 00-0 BRCAU/S — 1 TRAU — 0 BTAUG — 1 TAUG — 00-0 BRCAU — 00-0 BRCAU/S — 0 BCAU — 1 BTCUA — 1-11/2 BTRCAU — MCPC 21 — BRPC 27-35 — BRCP 28-36 — M 14 — MC 14 — MPL 14 — MP2L 14 — MP 18 - MCP 18-20-21 — MP2L18 — DAP 27 — ZAPL 38 — VPL 35 — BRP 37 — BRF 37 — BRPL 37-47 — BRP 38-48 — TRP2L 55 — TRCP2L 55 — BRPS 38	6CS163B
56123	Dx	carrellati: 45 BRCU/A — 0 BCUAG/A — 45 BRCUS/A — 30 ZRCU. trainati: 0 BT/F-G — 0 BT/FI-GI — 0 TQR/F-FI portati — MRCPL 28/A — 35 MRPS/A — MPSC 30/A — 40 MZ/E — BRCPL 48/A — 50 BRPS/A — BPSC 60 — 60-80 BZ/E — 60 BZS — 80 BZS/A — 100 BTZ — 110 BTZS — 130 QTZ/E — ZCPL 38 — MRCP 28/H — BP 48/H BRCP 48/H — BTRCP 52-70/H — QPRT 140/C — TQRT 90/C — QPS 140 U/A — PES 140/UA — DAP 38/A — ZAP 45 — TOP 90 SI — MCPL 28	7C162B
56124	Sx	vecchia produzione — 45 BRCU — 0 BCUAG — MRCPL 28 — 35 MRPS — MPSC 30 — BRCPL 48 — 50 BRPS — BPSC 48 — 40 MZ — 60-80 BZ — 80 BZ/C — 130 QTZ — 130 QTZ/A-D — MRCP 28/D-F — BP 48/D-F — BRCP 48/D-F-G — BTRCP 52/D-E-F — BTRCP 70/D-F — TQRT 90 — TQRT 90/A — QPRT 140 — QPRT 140/A-B — QPS 140 — PES 140 — DAP 38 — ZBAP 60 — 1-11/2 BRAU — 1-11/2 BRAU/SL — 2 TRAU — 0 BAUG — 21/2-3 TRAU — 1-11/2 BRCAU — 1-11/2 BRCAU/S — 21/2-3 BTRCAU — 0 BT/A-B-C-D — MRCP 27-28 — MPFS 30 — MRPL 27 — MRP 27 — MPL 28 — MRPO 28 — ZF 32 — ZAPL 38 — BPP 40 — BCPP 40 — BRP 40-47 — BRPC 40-48 — MRPS 28 — 1-11/2 BAU - DAP 35	7CS162B
56125	Dx	carrellati: 30 MRCU/A — 30 MRCUS/A — 50 BRCU/A — 0 BRAUG/A — 50 BRCUS/A — 2 BTCAUG/F — 35 ZRACU — 35 ZRACUI trainati: 0 BTR/F-G — 0 BTR/FI-GI portati: MRCPL 38/A — 40 MRPS/A — MPSC 50 — 70 BRPS/A — BPSC 70/A — 90 BZ/E — 90 BZS/A — BTRCPL 80 — 120 TZ/E — ZCPL 48 — MCP 38/H — MP 46/H — MRCP 38/H — BP 58/H — BRCP 58/H — BTRCP 80/H — TQRT 150/C — DAP 48/A — ZAP 60 — TQR 150 — PESS 150 — QPRT 150/C	8C163B
56126	Sx	vecchia produzione: 30 MRCU — 50 BRCU — 0 BRAUG — 2 BTCAUG — 35 ZRCU — 35 ZRCUI — MRCPL 38 — 40 MRPS — MPSC 38 — 70 BRPS — BPSC 70 — 90 BZ — 90 BZ/C — 120 TZ — 120 TZ/D — MCP 38/D-F — MP 46/D-F — MRCP 38/D-F — BP 58/D-F — BRCP 58/D-F-G — BTRCP 80/D-F — TQRT 150 — TQRT 150/A — QPRT 150 — QPRT 150/A — DAP 48 — ZBAP 90/A — 00 MRAU — 00 MRAU/S — 00 MCAU — 00 MRCAU — 1 BCAU — 00MRCAU/S — 11/2 BRRCAU — 11/2 BRRCAU/S — 0 BTR — MCPL 38 — BPFS 30 — MRPS 35-36-38 — MPFS 40 — MRP 37 — MRPO 38 — MRPI 37-38 — MPL 38 — DAP 40 — ZF 45 — BRPL 55 — BRPC 58 — BTRCP 80 — BRPS 58 — MRPS 38	8CS163B

Ricambi per Aratri

EXCHANGES FOR PLOUGHS

03

03

segue RICAMBI PER ARATRI

RECHANGES POUR CHARRUES - EXCHANGES FOR PLOUGHS - ERSATZTEILEN FUER PFLUGE - RECAMBIOS PARA ARADOS

ARTICOLO	LATO	ATTREZZI SUI QUALI VENGONO MONTATI	OEM NARDI
56127	Dx	carrellati: 35 MRCU/A — 35 MRCUS/A — 55 BRCU/A — 60 BRCUA — 1 BRCUAG/F — 45 ZRCU — 35 ZRCUI trainati: 1 BT/F-G — 1 BT\FI-GI — T TQ/F-FI	9C163B
	Sx	portati: 50 MRPS — MPSC 60 — 60 MZ/E — 60 MZS — BRCPL 80 — 100 BZ/E — 110 BZS — 115 BDF — 130 TZ/E — 180 QTZ/E — MRCP 47 — BCP 70/H — BRCP 68-70/H — BTRP 100/A vecchia produzione: 35 MRCU — 50 BRRCU — 55-60 BRCU — 1 BRCAUG — MCPSC 48 — 60 MZ — 100 BZ — 130 TZ — 130 TZ/D — 180 QTZ — 180 TQZ/A — BCP 70/D-F — BRCP 68 — BRCP 70/D-F — 0 MRAU/SP — 2 BRAU — 21/2 BLRAU — 1 BAUG — 3 TAUG — 1/BT/A-B-C-D-E — 1 TQR — 1 DBT/A-B — 2 RDTQ — 2 QPR — MPP 40 — MRPS 48 — MPSC 48 — BRPL 80 — BTRP 100 — 100 BZ/C — 130 QTZ — 130 QTZ/D	9CS163B
56129	Dx	carrellati: 45 MRCU — 45 MRCUS — 65 BRCUA — 2 BRAUG/F — 50 ZRCU — 60 ZRCUI trainati: 2 BT/F-G — 2 BT\FI-GI — 2 TQR/F-FI	10C163B
	Sx	portati: MRCPL 48 — 55 MRPS — MPSC 70 — 80-81 MZ/C — 80 MZS/A — 95 BRPS/A — 120-121 BZ/D — MCP 48/H — MRCP 48/H — BRCP 90/A — BTRP 110/A vecchia produzione: 65 BRCU — 2 BRAUG — 80-81 MZ — 120-121 BZ — 95 BRPS — MCP 48/D-F — MRCP 48/D-F — 1-11/2 MRAU — 1-11/2 MRAU/S — 0 MAUG — 2 BAUG — 2 BAUG/F — 21/2 BRAU — 3 BRAU — 2 DBT/A-B — 2 DBTR — 3 QPR — MP 48/D — MRP 47 — MRPL 47 — MRPL 48-49 — BRCP 90 — BTRP 110 — 2 BT/A-B-C-D-E	10CS163B
56131	Dx	carrellati: 55 MRCU — 50 MRCUA — 1 MCUAG/F portati: 100 MZ/C — 110 MZS — 115 MDF — 135 BRPS/A — 140 BZ//D — MCP 58/H — MRCP 58/H — BTS 120	13C164B
56862	Dx	trainati - 2 1/2 BT/F-G - 21/2 BT/F1-GI	12C163B
56863	Sx	vecchia produzione - 21/2 BT/A-B-C-D-E - 3 BAUG - 2 BTR/A-B-C - 3TQR/A - 3 BT/A-B-C - 4QPR	12CS163B

SALVAVERSOI PER ARATRO A SCALPELLO - NARDI

PROTEGE VERSOIR POUR CHARRUE A POINTE - NARDI

MOLDBOARD GUARD FOR CHISEL PLOUGHS - NARDI

STREICHBLECHSCHUTZ FÜR MEISSELPFLUG - NARDI

PROTECCIONES VERTEDERAS PARA ARADO DE CINCEL - NARDI

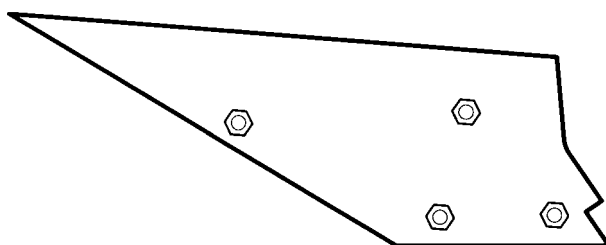

ARTICOLO	DESCRIZIONE	OEM
56282	SALVAVERSOIO	10C185B 10C185MB
56284	SALVAVERSOIO	12C185M
56285	SALVAVERSOIO	13C185
56286	SALVAVERSOIO	14C185

segue RICAMBI PER ARATRI

RECHANGES POUR CHARRUES - EXCHANGES FOR PLOUGHS - ERSATZTEILEN FUER PFLUGE - RECAMBIOS PARA ARADOS

RICAMBI PER ARATRI TIPO NARDI SENZA SCALPELLO

PIECES POUR CHARRUE TYPE NARDI SANS BURIN
SPARE PARTS FOR PLOUGHS WITHOUT CHISEL TYPE NARDI
ERSATZTEILE FÜR PFLÜGE TYP NARDI OHNE MEISSEL
REPUESTOS POR ARADOS TIPO NARDI SIN CINCEL

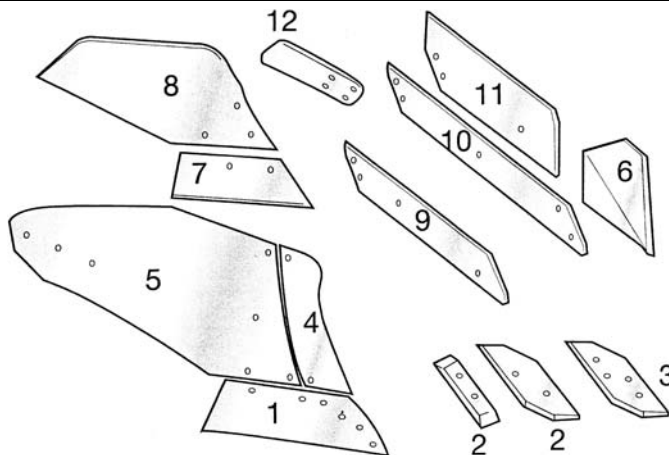

ARTICOLO		DESCRIZIONE	APPLICAZIONI	RIF.
DX	SX			
56705	56813	VOMERE TIPO NARDI 6C20-6CS20	Per corpi lav.: UN-6 · UN-7 su balestrati idropneumatici, BPD - TPD - QPD Portati: 68 BZNS-300/A · 73 BZNS-350/A · BTZN 300 · BTZN 350 · UN 6 · UN 7 · 103 BTZNFS 300/A · 123 BTZNFS-350/A · 160 BTZN-PV · 160 BTZN, TQZN-PV-BTZN · TQPZN 300 · BTZN · TQPZN 350 · TQPZN 300 · TQPZN 350 · 123 - TQZNFS-300/A · 163TQZNFS-350/R · 163 · TQZNFS-350/A · 160TQZN-PV · EITQPN 300 · EITQPN 350 · QPS 13 O U/SM 300 · CN9 · UN9	1
57495	57496	VOMERE TIPO NARDI 7C35-7CS35	Per corpi lav.: EN-6 · CN-6 · EN7 · CN7 su balestrati, idropneumatici, BPD · TPD · QPD	1
56706	56814	VOMERE TIPO NARDI 8C35-8CS35 - 2 fori	Per corpi lav.: CN-8 · CN-10 su BPD · TPD · QPD	1
56707	56815	VOMERE AVANVOMERE TIPO NARDI 1C43A-1CS43A	-	7
56708	56816	SCALPELLO TIPO NARDI 7C60-7CS60 - 4 fori	Per corpi lav.: UN-7 su balestrati, idropneumatici, BPD · TPD · QPD	3
57497	57498	SCALPELLO TIPO NARDI 5C60-5CS60 - 2 fori	Per corpi lav.: CN-8 · EN-6 · CN-7 · EN-7 su balestrati, idropneumatici, BPD · TPD · QPC	2
57499	57500	SCALPELLO TIPO NARDI 6C60-6CS60 - 2 fori	Per corpi lav.: UN-6 su balestrati, idropneumatici, BPD · TPD · QPD	2
56709	56817	SCALPELLO TIPO NARDI 8C60-8CS60 - 2 fori	Per corpi lav.: CN-8 · CN-10 su BPD · TPD · QPD	2
56711	56819	SUOLA TIPO NARDI 6C140A-6CS140A - CORTA ANTERIORE PER CORPI NORMALI	Per corpi lav.: UN-6 · UN-7	9
57501	57502	SUOLA TIPO NARDI 6C142A-6CS142A - CORTA ANTERIORE PER CORPI NORMALI	Per corpi lav.: EN-6 · CN-6 · EN-7 · CN-7	9
57503	57504	SUOLA TIPO NARDI 8C142A-8CS142A - CORTA ANTERIORE PER CORPI NORMALI	Per corpi lav.: CN-8	9
57505	57506	SUOLA TIPO NARDI 10C142A-10CS142A - CORTA ANTERIORE PER CORPI NORMALI	Per corpi lav.: CN-10 (entro solco)	9
57507	57508	SUOLA TIPO NARDI 10C142AFS-10CS142AFS - CORTA ANTERIORE PER CORPI NORMALI	Per corpi lav.: CN-10 (bivomere fuori solco)	9
56710	56818	SUOLA TIPO NARDI 6C140-6CS140 - LUNGA POSTERIORE PER CORPI NORMALI	Per corpi lav.: UN-6 · UN-7	10
57509	57510	SUOLA TIPO NARDI 6C142-6CS142 - LUNGA POSTERIORE PER CORPI NORMALI	Per corpi lav.: EN-6 · CN-6 · EN-7 · CN-7	10
57513	57514	SUOLA TIPO NARDI 10C142-10CS142 - LUNGA POSTERIORE PER CORPI NORMALI	Per corpi lav.: CN-10 (trivomeri fuori solco)	10
57515	57516	SUOLA TIPO NARDI 10C142FS-10CS142FS - LUNGA POSTERIORE PER CORPI NORMALI	Per corpi lav.: CN-10 (bivomeri fuori solco)	10
56712	56820	SALVA SUOLA TIPO NARDI 6C150-6CS150	Per corpi lav.: UN-6 · UN-7	11
56713	56821	PREVERSOIO TIPO NARDI 7C190-7CS190	Portati: 73 BZNS-350/A · BTZN 350 · UN 7 · 123 BTZNFS-350/A · BTZN TQPZN 350 · 163 TQZNFS-350/A · BTQPN 350 Per corpi lav.: UN-6 · EN-7	4
57547	57548	PREVERSOIO TIPO NARDI 6C190-6CS190	Per corpi lav.: UN-6 · UN-7	4
57517	57518	PREVERSOIO TIPO NARDI 9C190-9CS190	Portati: 160 BTZN-PV · 160 TQZN-PV · CN-9	4
57519	57520	PREVERSOIO TIPO NARDI 6C191-6CS191	Per corpi lav.: UN-6 · EN-6	4
57521	57522	PREVERSOIO TIPO NARDI 7C191-7CS191	Per corpi lav.: UN-7 · EN-7	4
57523	57524	PREVERSOIO TIPO NARDI 6C192-6CS192	Per corpi lav.: CN-6	4
57525	57526	PREVERSOIO TIPO NARDI 7C192-7CS192	Per corpi lav.: CN-7	4
57527	57528	PREVERSOIO TIPO NARDI 8C192-8CS192	Per corpi lav.: CN-8	4
57529	57530	PREVERSOIO TIPO NARDI 9C192-9CS192	Per corpi lav.: CN-10	4
56714	56822	VERSOIO TIPO NARDI 7C175-7CS175	Portati: 73 BZNS-350/A · BTZN 350 · UN 7 · 123 BTZNFS-350/A · BTZN TQPZN 350 · 163 TQZNFS-350/A · BTQPN 350 Per corpi lav.: UN-6 · EN-6	5
57531	57532	VERSOIO TIPO NARDI 6C175-6CS175	Per corpi lav.: UN-6 · EN-6	5
57533	57534	VERSOIO TIPO NARDI 9C175-9CS175	Portati: 160 BTZN-PV · 160 TQZN-PV · CN-9	5
57535	57536	VERSOIO TIPO NARDI 6C205-6CS205	Per corpi lav.: CN-6	5
57537	57538	VERSOIO TIPO NARDI 7C205-7CS205	Per corpi lav.: CN-7	5
57539	57540	VERSOIO TIPO NARDI 8C205-8CS205	Per corpi lav.: CN-8	5
57541	57542	VERSOIO TIPO NARDI 9C205-9CS205	Per corpi lav.: CN-10	5
57543	57544	VERSOIO AVANVOMERE TIPO NARDI 2C179-2CS179	Per supporti corpi lavoranti	8
57545	57546	VERSOIO AVANVOMERE TIPO NARDI 3C179-3CS179	Per supporti corpi lavoranti	8
56715	56823	COLTRO DA BASSO TIPO NARDI PER TQR 6C275-6CS275	Per corpi lav.: UN-6 · UN-7 · CN-8	6
57549	57550	COLTRO DA BASSO TIPO NARDI PER TQR 4C275-4CS275	Per corpi lav.: CN-6 · EN-6 · CN-7 · EN-7	6
57551	57552	COLTRO DA BASSO TIPO NARDI PER TQR 8C275-8CS275	Per corpi lav.: CN-10	6
57553	57554	ORECCHIA MOBILE PER NARDI 5C181-5CS181	Per corpi lav.: CN-7	12
57555	57556	ORECCHIA MOBILE PER NARDI 7C181-7CS181	Per corpi lav.: CN-8	12

Ricambi per Aratri

EXCHANGES FOR PLOUGHS

03

03

segue RICAMBI PER ARATRI

RECHANGES POUR CHARRUES - EXCHANGES FOR PLOUGHS - ERSATZTEILEN FUER PFLUGE - RECAMBIOS PARA ARADOS

VOMERI IN ACCIAIO AL SILICIO per corpi a scalpello, forati e verniciati SOGEMA

SOCS EN ACIER AU SILICE pour corps à rasette, percés et peints SOGEMA
 SILICON STEEL SHARES for SOGEMA perforated and painted chisel-share implements
 SCHARE AUS SILIZIUMSTAHL für Meißelkörper, gelocht und lackiert SOGEMA
 REJAS DE ACERO AL SILICIO para cuerpos de cincel, perforadas y pintadas SOGEMA



ARTICOLO	LATO	ATTREZZI SUI QUALI VENGONO MONTATI	OEM SOGEMA
56059	-	18 TPSR — 18 BP — 18 BT — 18 TB — 18 TP	OVS
56060	Dx	20 BT — 25 BTA — 28 BTA — 25 TBA — 28 TBA — 25 MPA — 28 MPA — 20 BP — 25 BPA — 28 BPA — 24 BP — 20 TP — 25 TP — 28 TPA	1/2 VS
56864	Sx		
56061	Dx	35 MTA — 30 BTA — 32 BTA — 34 BTA — 35 BTA — 35 TBA — 30 TBA — 32 TBA — 30/D — 30 MPA — 35 MPA — 30 BPA — 32 BPA — 34 BPA — 30 TPA — 32 TPA — 35 TPA — 35 BPAAAA	1VS
56865	Sx		
56062	Dx	38 MTA — 40 MTA — 38 BTA — 38 MPA — 40 MPA — 38 BPA — 40 BPA — 36 D — 38 D — 38 TBA	2VS
56866	Sx		
56063	Dx	44 MPA — 46 MPA — 44 BPA — 46 BPA — 49 BP — 42 BT Virg. — 43 BT Virg. — 43 TB Virg.	2VS-L (3 fori)
56867	Sx		
56064	-	52 M — 47 BT — 50 D — 50 MP — 47 BT Virg. — 47 BTR Virg. — 47 TB Virg. — 47 TBR Virg. — 50 BT	3VS
56065	-	52 M — 54 M — 55 M — 52 MP — 54 MP — 52 M Leon. — 65 M Leon. — 65 MR Leon. — 65 MPFSI	4 VS
56868	Dx	55/MP — 57/MP — 65/MD — 65/MDR	4 1/2 VS

SCALPELLI IN ACCIAIO BORO-CARBONIO forati e verniciati SOGEMA

POINTES EN ACIER BORE-CARBONE percées et peintes SOGEMA
 CHISEL-SHARES IN BORON-CARBON STEEL perforated and painted SOGEMA
 MEISSEL AUS BOR-KOHLLENSTOFFSTAHL gelocht und lackiert SOGEMA
 CINCELES DE ACERO BORO-CARBONO perforadas y pintadas SOGEMA



ARTICOLO	LATO	ATTREZZI SUI QUALI VENGONO MONTATI	OEM SOGEMA
56067	Dx	20 BT — 25 BTA — 28 TBA — 20 BTA — 20 TB — 25 TBA — 25 MPA — 28 MPA — 20 BP — 24 BPA — 25 BPA — 28 BPA — 20 TP — 25 TP — 28 TPA	30 x 30
56869	Sx		
56068	Dx	35 MTA — 30 BTA — 32 BTA — 35 BTA — 30 TBA — 32 TBA — 30D — 30 MPA — 35 MPA — 30 PA — 32 BPA — 34 BPA — 35 BPA — 30 TPA — 32 TPA — 35 TPA — 35 TBA	35 x 35
56167	Sx		
56069	Dx	38 MTA — 40 MTA — 44 MTA — 45 MTA — 46 MTA — 38 BTA — 42 BTA — 38 TBA — 44 BTA — 42 TB — 36 D — 38 D — 40 D — 42 D — 44 D — 46 D — 38 MPA — 40 MPA — 42 MPA — 44 MPA — 46 MPA — 38 BPA — 40 BPA — 42 BPA — 44 BPA — 46 BPA — 49 BP — 38 TPA — 42 BT Virg. — 43 BT Virg. — 43 BT Virg.	40 x 40
56168	Sx		
56070	Dx	50 M — 52 M — 54 M — 50 MP — 52 MP — 54 MP — 47 BT Virg. — 47 TB Virg. — 52 M Leon. — 47 BT	45 x 45
56870	Sx		

segue RICAMBI PER ARATRI

RECHANGES POUR CHARRUES - EXCHANGES FOR PLOUGHS - ERSATZTEILEN FUER PFLUGE - RECAMBIOS PARA ARADOS

SUPPORTO SCAPPELLO IN ACCIAIO AL CARBONIO forati e verniciati SOGEMA

SUPPORT POINTE EN ACIER AU CARBONE percés et peints SOGEMA
 CARBON STEEL CHISEL SUPPORT perforated and painted SOGEMA
 MEISSELTRÄGER AUS NORMSTAHL gelocht und lackiert SOGEMA
 SOPORTE CINCEL DE ACERO AL CARBONO perforados y pintados SOGEMA

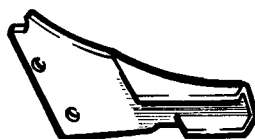

ARTICOLO	LATO	ATTREZZI SUI QUALI VENGONO MONTATI	OEM SOGEMA
56031	Dx	20 BT — 25 BTA — 28 BTA — 20 TB — 25 TBA — 28 TBA — 25 MPA — 28 MPA — 20 BP — 24 BPA — 25 BPA — 28 BPA — 20 TP — 24 TPA — 25 TPA — 28 TPA	00/SS
56032	Sx		00/SSS
56078	Dx	30 BTA — 32 BTA — 34 BTA — 35 BTA — 30 BPA — 32 BPA — 35 BPA — 30 TBA — 32 TBA 35 TBA — 30 TPA — 32 TPA — 35 TPA — 35 MTA — 30 D — 30 MPA — 35 MPA	0/SS
56079	Sx		0/SSS
56080	Dx	38 M — 40 M — 38 MP — 40 MP — 36 D — 38 D — 38 BT	1/SS
56081	Sx		1/SSS
56082	Dx	38 MTA — 40 MTA — 38 BTA — 36 D — 38 D — 40 D — 38 MPA — 38 TBA — 38 MPA — 40 MPA — 38 BPA — 40 BPA — 38 TPA	11/2/SS
56871	Sx		11/2/SSS
56083	Dx	44 MTA — 45 MTA — 46 MTA — 42 BTA — 44 BTA — 42 TB — 42 D — 44 D — 46 D — 42 MPA — 44 MPA — 46 MPA — 44 BPA — 46 BPA — 49 BP — 42 BT Virg. — 43 BT Virg. — 49 MP	2/SS
56084	Dx	50 M — 52 M — 54 M — 47 BT — 50 M — 52 MP — 54 MP — 47 BT Virg. — 47 TB Virg. — 52 M. Leon	3/SS
56085	Dx	50 D — 47 BTR Virg. — 47 TBR Virg. — 57 MP	4/SS

SUOLE IN ACCIAIO AL CARBONIO SOGEMA

SEMELLES EN ACIER AU CARBONE SOGEMA
 SOGEMA SHOES IN CARBON STEEL
 SOHLEN AUS SILIZIUMSTAHL SOGEMA
 ZAPATAS DE ACERO AL CARBONO SOGEMA



ARTICOLO	LATO	ATTREZZI SUI QUALI VENGONO MONTATI	OEM SOGEMA
56087	Dx	30/BTA — 32/BTA — 34/BTA — 35/BTA — 38/BTA — 30/TBA — 42/TBA — 35/TBA — 38/TBA — 30/BPA — 32/BPA — 35/BPA — 38/BPA — 40/BPA — 30/BPA — 32/TPA — 35/TPA — 38/TPA	00/PAS
56872	Sx		00/PASS
56088	Dx	20/BT — 20/BP — 20/TB — 20/TP — 24/BPA — 24/TPA	1/2PAS
56089	Dx	25/BTA — 28/BTA — 25/BPA — 28/BPA — 25/TBA — 28/TBA — 25/TPA — 28/TPA	1/PAS
56090	Dx	42/TBA — 44/TBA — 42/BT Virg. — 44/BPA — 46/BPA — 49/BP — 42/TB — 42/TB Virg. — 43/TB Virg. 42/BP-A	2/PAS
56091	Dx	47/B Virg. — 47/BTR Virg. — 47/TB Virg. — 47/TBR Virg. — 47/TBA — 49/BP-R — 50/BP — 52/BP — 49/BP-G	3/PAS

Ricambi per Aratri

EXCHANGES FOR PLOUGHS

03

03

segue RICAMBI PER ARATRI

RECHANGES POUR CHARRUES - EXCHANGES FOR PLOUGHS - ERSATZTEILEN FUER PFLUGE - RECAMBIOS PARA ARADOS

TALLONE IN ACCIAIO AL CARBONIO SOGEMA

TALON EN ACIER AU CARBONE SOGEMA
SOGEMA HEEL CASTINGS IN CARBON STEEL
ANLAGE AUS SILIZIUMSTAHL SOGEMA
TALÓN DE ACERO AL CARBONO SOGEMA

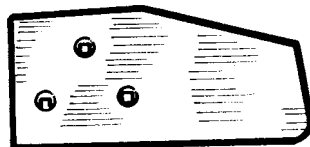

N.B.: Tutti i pezzi possono essere forniti, su richiesta, nella versione «sinistra»

ARTICOLO	LATO	ATTREZZI SUI QUALI VENGONO MONTATI	OEM SOGEMA
56092	Dx	25-28/MPA-MNPA — 24-25-28/BPA-BNPA 25-28/BTA — 28/BTB — 25-28/TPA — TNPA — 25-28/TBA — 25-28/TB	1/2/PCP
56873	Sx		
56093	-	25/BTA — 25/TBA — 28/BTA — 28/TBA	1/2/TP
56094	Dx	35-38-40/MT-A — 30-36-38-49/D — DA — 30-32-34-35-38/BT-A — BT-B — 30-32-35-38/TB-A — TB	1 TP vecchia prod.
56095	-	35 MTA — 38 MTA — 40 MTA — 30 BTA — 32 BTA — 34 BT — 35 BTA — 38 BTA — 30 TBA — 32 TBA — 35 TBA — 38 TBA — 30 MPA — 30 BPA — 32 BPA — 35 BPA — 30 MNPA — 32 BNPA — 35 BNPA — 35 MNPA	1/PCP vecchia prod.
56096	Dx	30-35/MPA-MNPA — 38-40/MPA — 35-38-40/MTA — 30-32-34-35-38-40/BTA-BTB — 30-32-35/BPA-BNPA — BPB-BNPB — 38-40/BPA-BPB-DUPAO — 30-40/TPA-TPB-DUPAO — 30-32-34-35-38-40/TBA-TB — 30-32-35/TPA-TPB-TNPA-TNPB	1/PCP-L
56874	Sx		
56097	-	3790450 — 42 — 43/BT Virgilio — 42-43/TB Virgilio	2/TP vecchia prod.

VERSOI PER CORPI A SCALPELLO SOGEMA

VERSOIRS POUR CORPS A POINTE SOGEMA
MOLDBOARDS CHISEL ELEMENTS - SOGEMA
STREICHBLECHE FÜR MEISSELKÖRPER SOGEMA
VERTEDERAS PARA CUERPOS DE CINCEL SOGEMA

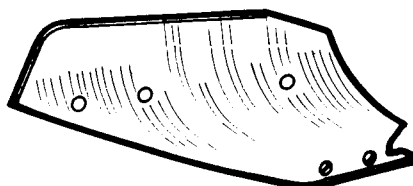

N.B.: Tutti i pezzi possono essere forniti, su richiesta, nella versione «sinistra»

ARTICOLO	LATO	ATTREZZI SUI QUALI VENGONO MONTATI	OEM SOGEMA
56103	-	28/BTA — 28/TBA — 28/MPA — 28/BPA — 28/TPA	28
56104	-	30/BTA — 30/TBA — 30/D — 30/MPA — 30/BPA — 30/TPA	30
56105	Dx	32/BTA — 32/TBA — 32/BPA — 32/TPA	32
56875	Sx		
56106	Dx	35/MTA — 35/BTA — 35/MPA — 35/BPA — 35/TBA — 35/TPA	35
56876	Sx		
56107	-	38/MTA — 38/BTA — 38/D — 38/MPA — 38/BPA — 38/TBA	38
56108	Dx	40/MTA — 40/MPA — 40/BPA	40
56877	Sx		
56109	-	44/MTA — 44/D — 44/MPA — 44/BPA	44

segue RICAMBI PER ARATRI

RECHANGES POUR CHARRUES - EXCHANGES FOR PLOUGHS - ERSATZTEILEN FUER PFLUGE - RECAMBIOS PARA ARADOS

SALVAVERSOI PER ARATRO A SCALPELLO - SOGEMA

PROTEGE VERSOIR POUR CHARRUE A POINTE - SOGEMA
MOLDBOARD GUARD FOR CHISEL PLOUGHS - SOGEMA
STREICHBLECHSCHUTZ FÜR MEISSELPFLUG - SOGEMA
PROTECCIONES VERTEDERAS PARA ARADO DE CINCEL - SOGEMA

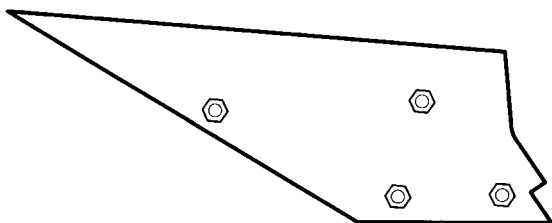

ARTICOLO	DESCRIZIONE	OEM
56287	SALVAVERSOIO	35
56289	SALVAVERSOIO	38
56291	SALVAVERSOIO	42
56293	SALVAVERSOIO	46

VOMERI - VOGEL & NOOT

SOC - VOGEL & NOOT
SHARE - VOGEL & NOOT
SCHARE - VOGEL & NOOT
REJAS - VOGEL & NOOT

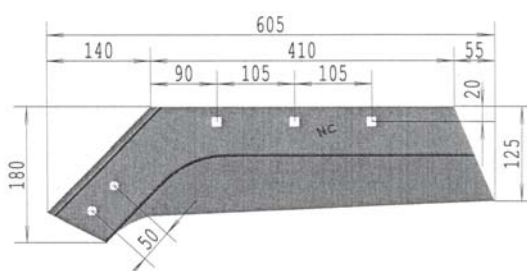

ARTICOLO	DESCRIZIONE	OEM
57374	Vomere Destro	UNM40
57375	Vomere Sinistro	UNM40L

VOMERINI - VOGEL & NOOT

SOCs DE RASLETTE - VOGEL & NOOT
SKIM POINTS - VOGEL & NOOT
DUNGEREINLEGGERSCHARE - VOGEL & NOOT
REJAS - VOGEL & NOOT

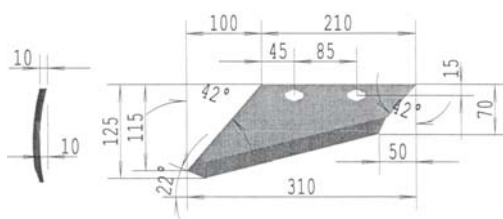

ARTICOLO	DESCRIZIONE	OEM
57378	Vomerino Destro	323101
57379	Vomerino Sinistro	323201

PUNTE REVERSIBILE - VOGEL & NOOT

POINTE REVERSIBLE - VOGEL & NOOT
REVERSIBLE POINT - VOGEL & NOOT
WECHSELSPITZEN - VOGEL & NOOT
REJAS - VOGEL & NOOT

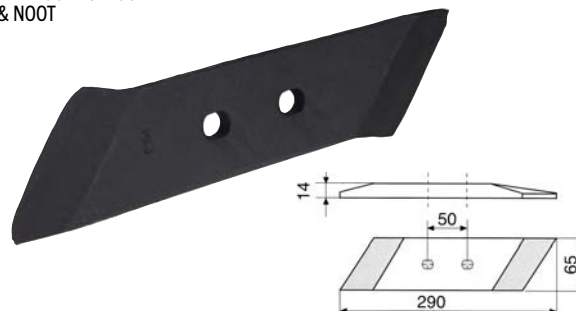

La foto rappresenta la versione DX (Art. 57380-57382)

ARTICOLO	DESCRIZIONE	OEM
57380	Punta reversibile Destra 12mm	PK8 - 12 mm
57381	Punta reversibile Sinistra 12mm	PK8 L - 12 mm
57382	Punta reversibile Destra 14mm	PK8 - 14 mm
57383	Punta reversibile Sinistra 14mm	PK8 L - 14 mm

VOMERI - VOGEL & NOOT

SOC - VOGEL & NOOT
SHARE - VOGEL & NOOT
SCHARE - VOGEL & NOOT
REJAS - VOGEL & NOOT

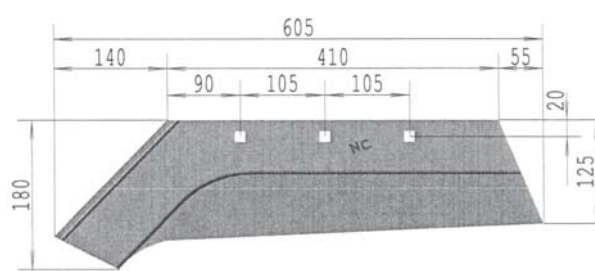

ARTICOLO	DESCRIZIONE	OEM
57376	Vomere Destro	-
57377	Vomere Sinistro	-

VOMERINI - VOGEL & NOOT

SOCs DE RASLETTE - VOGEL & NOOT
SKIM POINTS - VOGEL & NOOT
DUNGEREINLEGGERSCHARE - VOGEL & NOOT
REJAS - VOGEL & NOOT

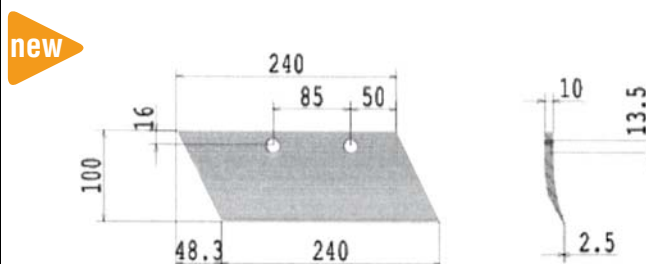

ARTICOLO	DESCRIZIONE	OEM
57592	Vomerino Destro	LZ135601
57593	Vomerino Sinistro	LZ135701

Ricambi per Aratri

EXCHANGES FOR PLOUGHS

03

03

segue RICAMBI PER ARATRI

RECHANGES POUR CHARRUES - EXCHANGES FOR PLOUGHS - ERSATZTEILEN FUER PFLUGE - RECAMBIOS PARA ARADOS

VITI PER ARATRO CON TESTA SVASATA ED ESAGONO INCASSATO CLASSE 10.9 CON DADI

VIS POUR CHARRUE A TETE EVASEE ET SIX PANS CREUX CLASSE 10.9 AVEC ECRIOUS
 PLOUGH BOLTS WITH COUNTERSUNK RECESSED HEXAGON HEADS CLASS 10.9 WITH NUTS
 SENKKOPFSCHRAUBEN FÜR PFLUG MIT INNENSECHSKANT KLASSE 10.9 MIT MUTTERN
 TORNILLOS PARA ARADO CON CABEZA AVELLANADA Y HEXAGONO HUECO CLASE 10.9 CON TUERCAS

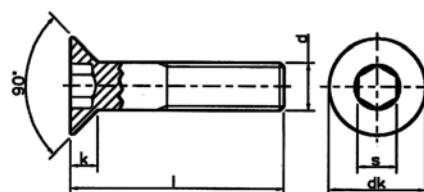

ARTICOLO	FILETTATURA d	s mm	dk mm	k mm	l mm
57267	M12	8	24	6,5	30
57268	M12	8	24	6,5	35
57269	M12	8	24	6,5	40
57270	M12	8	24	6,5	50
57271	M14	10	27	7	40
57272	M14	10	27	7	50
57273	M16	10	30	7,5	40
57274	M16	10	30	7,5	50

VITI PER ARATRO CON TESTA RIDOTTA E SVASATA A 120° QUADRO SOTTOTESTA ACCIAIO 8.8 - FILETTATURA METRICA - COMPLETI DI DADI

VIS POUR CHARRUE A TETE REDUITE ET EVASEE A 120° CARRE SOUS-TETE ACIER 8.8 - FILETAGE METRIQUE - AVEC ECRIOUS
 PLOUGH BOLTS WITH REDUCED-SIZE 120° COUNTERSUNK HEAD - SQUARE SHOULDER - STEEL 8.8 METRIC THREAD - COMPLETE WITH NUTS
 PFLUGSCHRAUBEN MIT REDUZIERTEM SENKKOPF 120° MIT VIERKANTANSATZ STAHL 8.8 - GEWINDE METRISCH - MIT MUTTERN
 TORNILLOS PARA ARADO CON CABEZA REDUCIDA Y AVELLANADA A 120° ESTRUCTURA ACERO 8.8 - ROSCADO MÉTRICO - CON TUERCAS

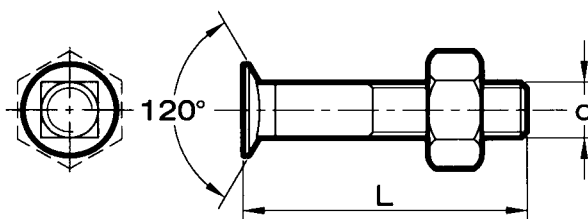

SINISTRI				DESTRO			
ARTICOLO	FILETTATURA d	LUNGHEZZA L - mm	NOTE	ARTICOLO	FILETTATURA d	LUNGHEZZA L - mm	NOTE
56294	M 14	35		56298	M 12	35	
56295	M 14	40		56741	M 12	50	
56297	M 16	45		56299	M 12	60	
				56300	M 14	40	
				56301	M 14	45	
				56302	M 14	50	
				56303	M 14	60	
				56304	M 16	40	
				56305	M 16	50	
				56306	M 16	60	

segue RICAMBI PER ARATRI

RECHANGES POUR CHARRUES - EXCHANGES FOR PLOUGHS - ERSATZTEILEN FUER PFLUGE - RECAMBIOS PARA ARADOS

BULLONI PER ARATRO SVASATI - CLASSI 8.8 E 10.9 CON DADI

BOULONS EVASES POUR CHARRUE - CLASSE 8.8 - 10.9 AVEC ECROUS
 COUNTERSUNK SQUARE NECK BOLTS - CLASSE 8.8 - 10.9 WITH NUTS
 ABGEFACKELTE BOLZEN 8.8 - 10.9 MIT MUTTERN
 TORNILLOS ARADO CON CUADRO - CLASE 8.8 - 10.9 CON TUERCAS

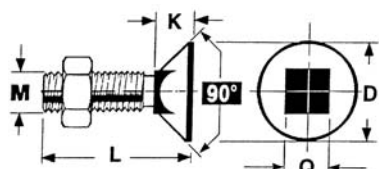

ARTICOLO	FILETTATURA M	CLASSE	L mm	K mm	D mm	Q mm
57395	M10	10.9	30	9	20	10,5
57396	M10		35	9	20	10,5
57397	M10		40	9	20	10,5
57398	M10		50	9	20	10,5
57399	M10		60	9	20	10,5
57400	M12	8.8	30	12,5	24,5	12
57401	M12	10.9	35	12,5	24,5	12
57402	M12		40	12,5	24,5	12
57403	M12		45	12,5	24,5	12
57404	M12		50	12,5	24,5	12
57405	M12		60	12,5	24,5	12
57406	M12		65	12,5	24,5	12
57407	M12		70	12,5	24,5	12
57408	M12		80	12,5	24,5	12
57409	M12		90	12,5	24,5	12
57437	M14		8.8	40	13,5	24,5
57410	M14	50		13,5	24,5	14
57439	M16	10.9	40	12,5	30	16
57440	M16		50	12,5	30	16
57441	M16		60	12,5	30	16

BULLONI PER ARATRO A TESTA CONICA OVALE - CLASSE 12.9 CON DADI

BOULONS A TETE CONIQUE OVALE POUR CHARRUE - CLASSE 12.9 AVEC ECROUS
 CONICAL HEAD BOLTS - CLASSE 12.9 WITH NUTS
 BOLZEN MIT OVALE KEGELE KOPF FUER PFLUGEN 12.9 MIT MUTTERN
 TORNILLOS CONICO-OVALADOS - CLASE 12.9 CON TUERCAS

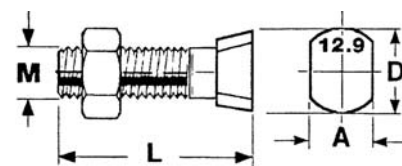

ARTICOLO	FILETTATURA M	L mm	D mm	A mm	APPLICAZIONI
57411	M12	34	16	14	KVERNELAND
57438	M12	38	16	14	-
57449	M12	42	16	14	-
57415	1/2" UNC	35	17,8	14,8	GREGOIRE
57412	M14	35	18	16	KVERNELAND
57413	M14	39	19	14,5	VOGEL
57414	M14	42	18	16	-

BULLONI PER ARATRO SVASATI A 90° CON ALETTE - CLASSE 8.8 CON DADI

BOULONS EVASES A 90° POUR CHARRUE - CLASSE 8.8 AVEC ECROUS
 DOUBLE NIB BOLTS - CLASSE 8.8 WITH NUTS
 90° ABGEFACKELTE BOLZEN MIT FLÜGEL 8.8 MIT MUTTERN
 TORNILLOS DE DOBLE TETON - CLASE 8.8 CON TUERCAS

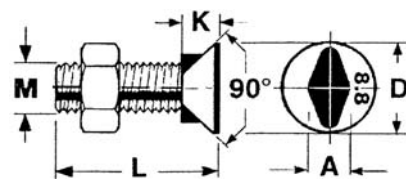

ARTICOLO	FILETTATURA M	L mm	K mm	D mm	A mm	APPLICAZIONI
57416	M10	30	3,5	16	10	-
57417	M12	35	5,5	20	12	KVERNELAND
57418	M12	40	5,5	20	12	KVERNELAND
57419	M14	35	7,5	24,5	14	-
57420	M14	40	7,5	24,5	14	-