



16

[www.cermag.com](http://www.cermag.com)

# Attrezzatura e Utensili per l'Agricoltura e il Giardinaggio

*OUTILS POUR L'AGRICULTURE ET LE JARDINAGE  
TOOLS FOR AGRICULTURE AND GARDENING  
WERKZEUGE FÜR LANDWIRTSCHAFT UND GARTENBAU  
HERRAMIENTAS PARA LA AGRICULTURA Y LA JARDINERÍA*

### FILO NYLON TONDO STARK LINE - ALTA QUALITÀ

FIL NYLON ROND STARK LINE-HAUTE QUALITÉ - STARK LINE-HIGH QUALITY-ROUND SECTION NYLON CORD - NYLONFADEN RUND STARK LINE-HOHE QUALITÄT - CABLE NYLON REDONDO STARK LINE-ALTA CALIDAD



| ARTICOLO     | DESCRIZIONE  |
|--------------|--------------|
| <b>26447</b> | Ø 1,6 - m 30 |
| <b>26448</b> | Ø 2,0 - m 25 |
| <b>26449</b> | Ø 2,4 - m 17 |
| <b>26450</b> | Ø 2,7 - m 14 |
| <b>26451</b> | Ø 3,0 - m 11 |
| <b>26452</b> | Ø 3,3 - m 9  |

| ARTICOLO     | DESCRIZIONE  |
|--------------|--------------|
| <b>26453</b> | Ø 2,4 - m 82 |
| <b>26454</b> | Ø 2,7 - m 67 |
| <b>26455</b> | Ø 3,0 - m 53 |
| <b>26456</b> | Ø 3,3 - m 44 |
| <b>26797</b> | Ø 4,0 - m 30 |

| ARTICOLO     | DESCRIZIONE   | PESO |
|--------------|---------------|------|
| <b>26800</b> | Ø 2,4 - m 540 | 3 kg |
| <b>26801</b> | Ø 2,7 - m 424 |      |
| <b>26802</b> | Ø 3,0 - m 345 |      |
| <b>26803</b> | Ø 3,3 - m 283 |      |
| <b>26804</b> | Ø 4,0 - m 195 |      |
| <b>28092</b> | Ø 5,0 - m 124 |      |
| <b>28093</b> | Ø 6,0 - m 86  |      |

### FILO NYLON QUADRATO STARK LINE - ALTA QUALITÀ

FIL NYLON CARRÉ STARK LINE-HAUTE QUALITÉ - STARK LINE-HIGH QUALITY-SQUARE SECTION NYLON CORD - NYLONFADEN VIERKANT STARK LINE-HOHE QUALITÄT - CABLE NYLON CUADRADO STARK LINE-ALTA CALIDAD



| ARTICOLO     | DESCRIZIONE  |
|--------------|--------------|
| <b>26457</b> | Ø 2,4 - m 17 |
| <b>26458</b> | Ø 2,7 - m 14 |
| <b>26459</b> | Ø 3,0 - m 11 |
| <b>26460</b> | Ø 3,3 - m 9  |

| ARTICOLO     | DESCRIZIONE  |
|--------------|--------------|
| <b>26461</b> | Ø 2,4 - m 63 |
| <b>26462</b> | Ø 2,7 - m 54 |
| <b>26463</b> | Ø 3,0 - m 45 |
| <b>26464</b> | Ø 3,3 - m 35 |
| <b>26798</b> | Ø 4,0 - m 25 |



| ARTICOLO     | DESCRIZIONE   | PESO |
|--------------|---------------|------|
| <b>26805</b> | Ø 2,4 - m 480 | 3 kg |
| <b>26806</b> | Ø 2,7 - m 378 |      |
| <b>26807</b> | Ø 3,0 - m 317 |      |
| <b>26808</b> | Ø 3,3 - m 253 |      |
| <b>26809</b> | Ø 4,0 - m 172 |      |
| <b>28094</b> | Ø 5,0 - m 110 |      |



| ARTICOLO     | DESCRIZIONE                                       |
|--------------|---|
| <b>27006</b> | Filo Ø 3,0 quadrato - 50 pz. - spezzoni da 300 mm |
| <b>27007</b> | Filo Ø 3,3 quadrato - 40 pz. - spezzoni da 300 mm |
| <b>27008</b> | Filo Ø 4,0 quadrato - 28 pz. - spezzoni da 300 mm |

**FIL NYLON TONDO STARK LINE ALUMINIUM - ALTA QUALITÀ**  
 FIL NYLON ROND STARK LINE-ALUMINIUM-HAUTE QUALITÉ - STARK LINE ALUMINIUM-HIGH QUALITY-ROUND SECTION NYLON CORD  
 NYLONMÄHFADEN RUND STARK LINE ALUMINIUM-HOHE QUALITÄT - CABLE NYLON REDONDO STARK LINE ALUMINIUM-ALTA CALIDAD



| ARTICOLO     | DESCRIZIONE  |
|--------------|--------------|
| <b>26855</b> | Ø 2,4 - m 17 |
| <b>27375</b> | Ø 2,7 - m 14 |
| <b>26856</b> | Ø 3,0 - m 11 |
| <b>26857</b> | Ø 3,3 - m 9  |

| ARTICOLO     | DESCRIZIONE  |
|--------------|--------------|
| <b>26858</b> | Ø 2,4 - m 82 |
| <b>27376</b> | Ø 2,7 - m 67 |
| <b>26859</b> | Ø 3,0 - m 53 |
| <b>26860</b> | Ø 3,3 - m 44 |
| <b>26861</b> | Ø 4,0 - m 30 |



| ARTICOLO     | DESCRIZIONE   | PESO |
|--------------|---------------|------|
| <b>26862</b> | Ø 2,4 - m 540 | 3 kg |
| <b>27377</b> | Ø 2,7 - m 424 |      |
| <b>26863</b> | Ø 3,0 - m 345 |      |
| <b>26864</b> | Ø 3,3 - m 283 |      |
| <b>26865</b> | Ø 4,0 - m 195 |      |

| ARTICOLO     | DESCRIZIONE   | PESO |
|--------------|---------------|------|
| <b>28571</b> | Ø 2,7 - m 141 | 1 kg |
| <b>28572</b> | Ø 3,0 - m 115 |      |
| <b>28573</b> | Ø 3,3 - m 95  |      |
| <b>28574</b> | Ø 4,0 - m 65  |      |

### FILO NYLON QUADRATO STARK LINE ALLUMINIUM - ALTA QUALITÀ

FIL NYLON CARRÉ STARK LINE-ALUMINIUM-HAUTE QUALITÉ - STARK LINE ALUMINIUM-HIGH QUALITY-SQUARE SECTION NYLON CORD - NYLONFADEN VIERKANT STARK LINE ALUMINIUM-HOHE QUALITÄT - CABLE NYLON CUADRADO STARK LINE ALUMINIUM- ALTA CALIDAD



| ARTICOLO     | DESCRIZIONE  |
|--------------|--------------|
| <b>26465</b> | Ø 2,4 - m 17 |
| <b>26466</b> | Ø 2,7 - m 14 |
| <b>26467</b> | Ø 3,0 - m 11 |
| <b>26468</b> | Ø 3,3 - m 9  |

| ARTICOLO     | DESCRIZIONE  |
|--------------|--------------|
| <b>26469</b> | Ø 2,4 - m 63 |
| <b>26470</b> | Ø 2,7 - m 54 |
| <b>26471</b> | Ø 3,0 - m 45 |
| <b>26472</b> | Ø 3,3 - m 35 |
| <b>26799</b> | Ø 4,0 - m 25 |



| ARTICOLO     | DESCRIZIONE   | PESO |
|--------------|---------------|------|
| <b>26810</b> | Ø 2,4 - m 480 | 3 kg |
| <b>26811</b> | Ø 2,7 - m 378 |      |
| <b>26812</b> | Ø 3,0 - m 317 |      |
| <b>26813</b> | Ø 3,3 - m 253 |      |
| <b>26814</b> | Ø 4,0 - m 172 |      |

| ARTICOLO     | DESCRIZIONE   | PESO |
|--------------|---------------|------|
| <b>28575</b> | Ø 2,7 - m 126 | 1 kg |
| <b>28576</b> | Ø 3,0 - m 106 |      |
| <b>28577</b> | Ø 3,3 - m 85  |      |
| <b>28578</b> | Ø 4,0 - m 58  |      |



| ARTICOLO     | DESCRIZIONE                                       |
|--------------|---|
| <b>27009</b> | Filo Ø 3,0 quadrato - 50 pz. - spezzoni da 300 mm |
| <b>27010</b> | Filo Ø 3,3 quadrato - 40 pz. - spezzoni da 300 mm |
| <b>27011</b> | Filo Ø 4,0 quadrato - 28 pz. - spezzoni da 300 mm |

### FILO NYLON ELICOIDALE STARK LINE - ALTA QUALITÀ

FIL NYLON HELICOIDAL STARK LINE-HAUTE QUALITÉ - STARK LINE-HIGH QUALITY-HELICAL NYLON CORD - NYLONMÄHFADEN OVAL STARK LINE-HOHE QUALITÄT - CABLE NYLON HELICOIDAL STARK LINE-ALTA CALIDAD



| ARTICOLO     | DESCRIZIONE  |
|--------------|--------------|
| <b>26815</b> | Ø 3,0 - m 45 |
| <b>26816</b> | Ø 3,3 - m 35 |
| <b>26817</b> | Ø 4,0 - m 25 |

| ARTICOLO     | DESCRIZIONE   |
|--------------|---------------|
| <b>27693</b> | Ø 3,0 - m 317 |
| <b>27694</b> | Ø 3,3 - m 253 |
| <b>27695</b> | Ø 4,0 - m 172 |



| ARTICOLO     | DESCRIZIONE   |
|--------------|---|
| <b>26818</b> | Filo Ø 3,0 elicoidale - 50 pz. - spezzoni da 300 mm |
| <b>26819</b> | Filo Ø 3,3 elicoidale - 40 pz. - spezzoni da 300 mm |
| <b>26820</b> | Filo Ø 4,0 elicoidale - 28 pz. - spezzoni da 300 mm |

### FILO NYLON TONDO WORK LINE

FIL NYLON ROND WORK LINE  
WORK LINE ROUND SECTION NYLON CORD  
NYLONMÄHFADEN RUND WORK LINE  
CABLE NYLON REDONDO WORK LINE



| ARTICOLO     | DESCRIZIONE  |
|--------------|--------------|
| <b>27496</b> | Ø 2,7 - m 67 |
| <b>27497</b> | Ø 3,0 - m 53 |
| <b>27498</b> | Ø 3,3 - m 44 |
| <b>27499</b> | Ø 4,0 - m 30 |

### FILO NYLON QUADRATO WORK LINE

FIL NYLON CARRÉ WORK LINE  
WORK LINE SQUARE SECTION NYLON CORD  
NYLONMÄHFADEN VIERKANT WORK LINE  
CABLE NYLON CUADRADO WORK LINE



| ARTICOLO     | DESCRIZIONE  |
|--------------|--------------|
| <b>27500</b> | Ø 2,7 - m 54 |
| <b>27501</b> | Ø 3,0 - m 45 |
| <b>27502</b> | Ø 3,3 - m 35 |
| <b>27503</b> | Ø 4,0 - m 25 |

### FILO PER SPOLLONATRICE

FIL POUR ÉBOURGEONNEUSE - TRUNK CLEANER WIRE - DRAHT FÜR REBGIPFELMASCHINE - HILO PARA DESBROZADORA

#### FILO TONDO PER SPOLLONATRICE

FIL ROND POUR ÉBOURGEONNEUSE  
TRUNK CLEANER ROUND WIRE  
RUNDER DRAHT FÜR REBGIPFELMASCHINE  
HILO REDONDO PARA DESBROZADORA

new



new

#### FILO QUADRATO PER SPOLLONATRICE

FIL CARRÉ POUR ÉBOURGEONNEUSE  
TRUNK CLEANER SQUARE WIRE  
VIERKANTDRAHT FÜR REBGIPFELMASCHINE  
HILO CUADRADO PARA DESBROZADORA



| ARTICOLO     | DESCRIZIONE   |
|--------------|---------------|
| <b>28559</b> | Ø 5,0 - m 368 |
| <b>28560</b> | Ø 6,0 - m 256 |

| ARTICOLO     | DESCRIZIONE   |
|--------------|---------------|
| <b>28561</b> | Ø 5,0 - m 326 |
| <b>28562</b> | Ø 6,0 - m 228 |

#### COPPIA CONICA UNIVERSALE

COUPLE CONIQUE UNIVERSEL  
UNIVERSAL BEVEL GEAR PAIR  
UNIVERSAL-KEGELRADGETRIEBE  
PAR CÓNICO UNIVERSAL



| ARTICOLO     |
|--------------|
| <b>27485</b> |

#### ISTRUZIONI PER IL MONTAGGIO

Utilizzare la Dima per Individuare l'inserto corretto



Con l'aiuto della chiave a tubo avvitare l'inserto alla Coppia Conica

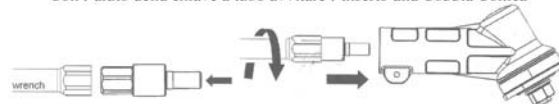

Misurare l'asta del decespugliatore e utilizzare, se necessario, la giusta riduzione

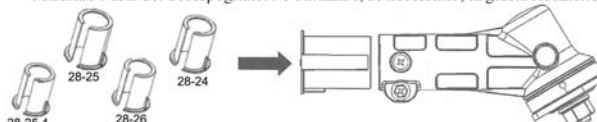

Presentare la Coppia Conica all'asta, segnare in corrispondenza della vite di bloccaggio, rimuovere la coppia conica dall'asta forare ed infine montare stringendo i vari componenti.

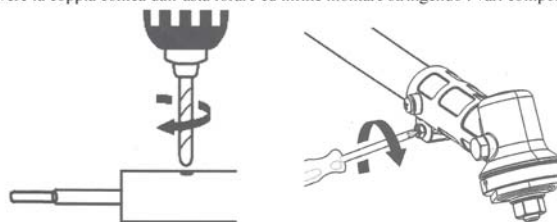

#### INSERTI OPTIONAL PER COPPIE CONICHE (da ordinare separatamente)

| ARTICOLO     | PROFILO | N. | DESCRIZIONE        |
|--------------|---------|----|--------------------|
| <b>27486</b> | □       | 1  | Inserto Quadro 5.1 |
| <b>27487</b> | □       | 2  | Inserto Quadro 5.4 |
| <b>27488</b> | □       | 3  | Inserto Quadro 6   |
| <b>27489</b> | ○       | 5  | Profilo Stihl 5.5  |
| <b>27490</b> | ○       | 6  | Profilo Stihl 6.5  |



| ARTICOLO     | PROFILO | N. | DESCRIZIONE                                |
|--------------|---------|----|--|
| <b>27491</b> | ⊙       | 7  | Inserto 7 Denti per macchine made in Japan |
| <b>27614</b> | ⊙       | 7  | Inserto 7 Denti per macchine made in Italy |
| <b>27492</b> | ⊙       | 8  | Inserto 8 Denti                            |
| <b>27493</b> | ⊙       | 9  | Inserto 9 Denti                            |
| <b>27494</b> | ⊙       | 10 | Inserto 10 Denti                           |
| <b>27495</b> | ⊙       | 11 | Inserto 11 Denti                           |

## TABELLA APPLICAZIONI TESTINE PER DECESPUGLIATORI

TABLEAU UTILISATIONS TETES DEBROUSAILLEUSES - HEADS APPLICATION TABLE FOR BRUSHCUTTERS -  
FADENKOPFANWENDUNGSTAFEL FÜR MOTORSSENSEN - TABLA DE APLICACION CABEZALES PARA DESBROZADORAS

| MARCA E MODELLI                          | MISURA ATTACCO | MARCA E MODELLI             | MISURA ATTACCO |
|--|----------------|-----------------------------|----------------|
| <b>ALPINA</b>                            |                | <b>MARUNAKA</b>             |                |
| 170-180-200                              | M8x1,25 S.M.   | G3-G5-G13K-GL3K             | M10x1,25 S.M.  |
| 210                                      | M10x1,25 S.F.  | G8K                         | M10x1,25 S.F.  |
| VIP 21-25-30-34-40                       | M8x1,25 S.M.   | <b>MARUYAMA</b>             |                |
| VIP 34-40 Flex                           | M8x1,25 S.M.   | MB 100-250-300-400-500      | M8x1,25 S.M.   |
| <b>ARIMITSU</b>                          |                | Serie BC, BK e MC           | M8x1,25 S.M.   |
| AM24 - AM31 - AM31KL                     | M8x1,25 D.F.   | 23                          | M10x1,5 S.F.   |
| AM24 - AM31 - AL31KL                     | M8x1,25 S.M.   | 35-35                       | M10x1,25 S.M.  |
| <b>CASTOR</b>                            |                | <b>McCULLOCH</b>            |                |
| Turbo 21-25-30-34-40                     | M8x1,25 S.M.   | Mac 17-Mac 25               | M8x1,25 D.F.   |
| Turbo 34-40 Duplex                       | M8x1,25 S.M.   | Mac 22-Mac 23-Mac 30-Mac 38 | M8x1,25 S.M.   |
| Turbo 34-40 Flex                         | M8x1,25 S.M.   | Mac 32-Mac 37               | M10x1,25 S.M.  |
| <b>CIFARELLI</b>                         |                | <b>MOUNTFIELD</b>           |                |
| C2-C21-C3-C31-C8                         | M10x1,25 S.F.  | 16-22-23-40                 | M8x1,25 S.M.   |
| <b>DOLMAR</b>                            |                | 31-37                       | M10x1,25 S.M.  |
| NB03-NB04                                | M10x1 S.F.     | <b>NIKKARI</b>              |                |
| <b>ECHO</b>                              |                | 22-24-37                    | M8x1,25 S.M.   |
| Standard 140-200-300-402-500             | M10x1,25 S.F.  | 33                          | M10x1,25 S.M.  |
| <b>EFCO</b>                              |                | <b>OLEO MAC</b>             |                |
| Serie 200                                | M8x1,25 S.M.   | 721                         | M8x1,25 S.F.   |
| Serie 300                                | M8x1,25 S.M.   | 727C-727S-727T              | M8x1,25 S.M.   |
| <b>FERRITALIA</b>                        |                | 733S-733T-433BP             | M8x1,25 S.M.   |
| TK-TM-TX-NBA                             | M8x1,25 S.M.   | <b>PARTNER</b>              |                |
| PNB                                      | M10x1,25 S.M.  | 200-205                     | M10x1,25 S.F.  |
| <b>FUJI - ROBIN</b>                      |                | B370                        | M12x1,75 S.M.  |
| NB02-NB16F                               | M8x1,25 S.F.   | <b>SHIKUNATI</b>            |                |
| NB23F                                    | M10x1,25 D.F.  | 122                         | M8x1,25 S.F.   |
| NB03-NB04                                | M10x1 S.F.     | LK350                       | M10x1 S.F.     |
| <b>HUSQVARNA</b>                         |                | L155-L183-L185              | M10x1,5 S.F.   |
| 24R                                      | M7x1 S.M.      | P850                        | M8x1,25 S.M.   |
| H27-GTS-26GT                             | M10x1,5 S.F.   | <b>SHINDAIWA</b>            |                |
| 36R-140R-165-244                         | M12x1,75 S.F.  | T20                         | M7x1 S.M.      |
| <b>IRINO</b>                             |                | R20-R25-R35-C25-F20-T25     | M8x1,25 S.M.   |
| LA17-S5-SH17                             | M8x1,25 S.M.   | C35                         | M10x1,25 S.M.  |
| LB20-LB24                                | M10x1 S.F.     | B40                         | M10x1,25 S.F.  |
| <b>ISEKI</b>                             |                | <b>SHINGU-SHOKO</b>         |                |
| Standard 1c - 15-1c - 16-1c - 17-1c - 18 | M9x1,25 S.F.   | S100-S180-M16               | M6x1 S.M.      |
| <b>JONSERED</b>                          |                | 200-250-350-K301-300        | M7x1 S.M.      |
| R45                                      | M12x1,75 S.F.  | 600-650-P700-P750-P850      | M8x1,25 S.M.   |
| <b>YAMANA BEAVER</b>                     |                | <b>STIHL</b>                |                |
| SD (R) - KG (R) - NY (R)                 | M8x1,25 S.M.   | FS60-FS61-FS80-FS90         | M8x1,25 S.M.   |
| <b>KING</b>                              |                | FS150-FS200-FS410           | M12x1,25 S.F.  |
| 20-22-26-22Z-26Z                         | M8x1,25 S.M.   | <b>TANEGA</b>               |                |
| 30CS-40CS-31CS-41CS                      | M8x1,25 S.M.   | TA-TL                       | M8x1,25 S.M.   |
| <b>KAAZ</b>                              |                | <b>TAS</b>                  |                |
| V20                                      | M7x1 S.F.      | TBC16-TBC20-TBC23-TBC30     | M8x1,25 S.M.   |
| U10-K20-K30-RQ20-V25                     | M8x1,25 S.F.   | TBC37-SUM300-SUM301         | M8x1,25 S.M.   |
| RQ30 (fino marzo 1986)                   | M8x1,25 S.F.   | SUM3                        | M10x1,25 S.F.  |
| KQ P20-K2 Q20                            | M8x1,25 S.F.   | <b>WEED EATER</b>           |                |
| KT12-RQ30-KQ20                           | M8x1,25 S.F.   | 82-599-848                  | M8x1,25 S.M.   |
| KQ30-V10                                 | M8x1,25 D.F.   | PRO 37                      | M10x1,25 S.M.  |
| RQ30 (dopo marzo 1986)                   | M10x1,25 S.F.  | <b>ZANÈ</b>                 |                |
| K10-J40-JQ50-V15                         | M10x1,25 S.F.  | Standard                    | M10x1 S.F.     |
| V35-V40-RQ40                             | M10x1,25 S.F.  | <b>ZANOAH</b>               |                |
| J400-KQ30-KW 30NE                        | M10x1,25 S.F.  | BC254A-BCF01L-BC250DL       | M8x1,25 S.M.   |
| KT10-KT 1S-KT18-KT30                     | M10x1,25 S.F.  | BCF01-BCD20                 | M8x1,25 S.M.   |
| JQ                                       | M10x1 S.F.     | DC260DUM-BC340DW-K340F      | M8x1,25 S.M.   |
| <b>LANDONI</b>                           |                | BC43DWM-BC12L-BC324B        | M10x1,25 S.M.  |
| Standard                                 | M10x1 S.F.     | FBC12-FBC26-FBC33           | M10x1,25 S.M.  |

16

### TESTINA BATTI E VAI PROFESSIONALE FLAT 070

TÊTE PROFESSIONNEL "BATTI E VAI FLAT 070"  
 PROFESSIONAL HEAD "BATTI&VAI"  
 SCHNITTKOPF FUER KANTENSCHNEIDER  
 CABEZA PROFESIONAL "BATTI E VAI FLAT 070"

**ARTICOLO BREVETTATO**



#### CARATTERISTICHE

- Testina compatta diametro 135 mm, con funzionamento Batti e Vai senza pomello.
- Possibilità di abbinarle la ventola Art. 28021.
- Pomello di metallo montato su cuscinetto con soluzione coppa folle, incastonato nella parte inferiore.
- Estremamente semplice nella sostituzione del filo.
- Diametro filo Nylon utilizzabile da 2,4 a 4,5 mm.
- Realizzata con materiali ad alta resistenza all'usura.
- Tecnologia innovativa Brevettata.
- Attacco universale affidabile e sicuro.

|              |
|--------------|
| ARTICOLO     |
| <b>27701</b> |

### SOFFIATORE PER TESTINA BATTI E VAI FLAT 070

VENTILATEUR POUR TÊTE "BATTI E VAI"  
 BLOWER FOR "BATTI&VAI" HEADS  
 LUEFTER FUER "BATTI E VAI" KOPF  
 SOPLADOR PARA CABEZA "BATTI E VAI"



|              |
|--------------|
| ARTICOLO     |
| <b>28021</b> |

### TESTINA BATTI E VAI PROFESSIONALE THUNDER FLAT

TÊTE PROFESSIONNEL "BATTI E VAI THUNDER FLAT"  
 PROFESSIONAL HEAD "BATTI&VAI THUNDER FLAT"  
 SCHNITTKOPF FUER KANTENSCHNEIDER  
 CABEZA PROFESIONAL "BATTI E VAI THUNDER FLAT"

**new**

**ARTICOLO BREVETTATO**



#### CARATTERISTICHE

- Testina compatta diametro 116 mm, con funzionamento Batti e Vai senza pomello.
- Estremamente semplice nella sostituzione del filo.
- Diametro filo Nylon utilizzabile da 2,4 a 4,0 mm.
- Realizzata con materiali ad alta resistenza all'usura.
- Tecnologia innovativa Brevettata.
- Attacco universale affidabile e sicuro.

|              |
|--------------|
| ARTICOLO     |
| <b>28353</b> |



### TESTINE PER DECESPUGLIATORI UNIVERSALE

TETES DÉBROUSSAILLEUSES UNIVERSELLES - UNIVERSAL BRUSHCUTTER HEADS - FADENKÖPFE FÜR UNIVERSAL-MOTORSENSE - CABEZALES PARA DESBROZADORAS UNIVERSAL

#### TESTINA "NEW ATTILA" A FLAGELLI

TETE "NEW ATTILA" A FLÉAUX  
"NEW ATTILA" HEAD WITH FLAILS  
FADENKOPF "NEW ATTILA" MIT FLACHFADEN  
CABEZAL "NEW ATTILA" DE CUCHILLAS



#### CARATTERISTICHE

La testina "NEW ATTILA" è adatta per tutti i decespugliatori. Il sistema di taglio a flagelli flottanti è brevettato ed è conforme alle norme CE, garantendo ogni tipo di sicurezza nel suo impiego. La testina è particolarmente adatta per sterpaglia, rovi, arbusti, vegetazione di sottobosco.

**N.B.:** La testina viene venduta senza inserto.

ARTICOLO  
**27251**

#### TESTINA "NEW ATTILA" A FLAGELLI DOPPI

TETE "NEW ATTILA" A DOUBLE FLÉAUX  
"NEW ATTILA" HEAD WITH DUAL FLAILS  
FADENKOPF "NEW ATTILA" MIT ZWEI FLACHFADEN  
CABEZAL "NEW ATTILA" DE DOBLE CUCHILLAS



#### CARATTERISTICHE

La testina "NEW ATTILA A FLAGELLI DOPPI" garantisce un migliore taglio ed è adatta per tutti i decespugliatori. Il sistema di taglio a flagelli flottanti è brevettato ed è conforme alle norme CE, garantendo ogni tipo di sicurezza nel suo impiego. La testina è particolarmente adatta per sterpaglia, rovi, arbusti, vegetazione di sottobosco.

**N.B.:** La testina viene venduta senza inserto.

ARTICOLO  
**27262**

#### FLAGELLO PIATTO PER "NEW ATTILA"

FLÉAU PLAT POUR "NEW ATTILA"  
"NEW ATTILA" FLAT FLAIL  
FLACHER MÄHFADEN FÜR "NEW ATTILA"  
CUCHILLA PLANA PARA "NEW ATTILA"



ARTICOLO  
**27252**

**NB:** i flagelli sono perfettamente intercambiabili con il modello "ATTILA" vecchio.

#### SEMIBOCCOLA PER FLAGELLI

DEMI-BAGUE POUR FLÉAUX  
HALF-BUSH FOR FLAILS  
HALBBUCHSE FÜR MÄHFÄDEN  
SEMIBUJE PARA CUCHILLAS PLANAS

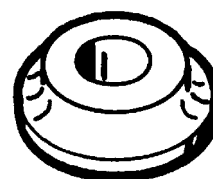

ARTICOLO  
**26080**

### segue TESTINE PER DECESPUGLIATORI UNIVERSALE

TETES DÉBROUSSILLEUSES UNIVERSELLES - UNIVERSAL BRUSHCUTTER HEADS - FADENKÖPFE FÜR UNIVERSAL-MOTORSENSE - CABEZALES PARA DESBROZADORAS UNIVERSAL

#### TESTINA BATTI E VAI CON ATTACCO UNIVERSALE SEMI PROFESSIONALE

TETE TAP AND GO A RACCORD UNIVERSEL SEMI PROFESSIONNELLE  
SEMI-PROFESSIONAL TAP'N GO HEAD WITH UNIVERSAL COUPLING  
FADENKOPF TAP AND GO MIT HALBPROFESSIONELLEM UNIVERSALADAPTER  
CABEZAL TAP & GO CON ACOPLAMIENTO UNIVERSAL SEMI PROFESIONAL



#### CARATTERISTICHE

- Testina compatta diametro 116 mm, con funzionamento Batti e Vai.
- Possibilità di sostituzione filo a testina chiusa.
- Diametro filo Nylon utilizzabile da 2,4 a 3,5 mm.
- Realizzata con materiali ad alta resistenza all'usura.
- Attacco universale affidabile e sicuro.
- Pomello di battuta in Nylon.

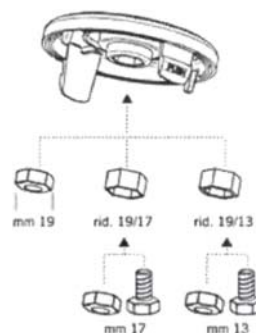

ARTICOLO  
**27012**

#### TESTINA BATTI E VAI CON ATTACCO UNIVERSALE SEMI PROFESSIONALE CON COPPA FOLLE

TETE TAP AND GO A RACCORD UNIVERSEL SEMI PROFESSIONNELLE A CARTER FOU  
SEMI-PROFESSIONAL TAP'N GO HEAD WITH IDLE HOUSING  
FADENKOPF TAP AND GO MIT HALBPROFESSIONELLEM UNIVERSALADAPTER MIT GLEITTELLER  
CABEZAL TAP & GO CON ACOPLAMIENTO UNIVERSAL SEMI PROFESIONAL CON CUERPO LIBRE



#### CARATTERISTICHE

- Testina compatta diametro 116 mm, con funzionamento Batti e Vai.
- Possibilità di sostituzione filo a testina chiusa.
- Diametro filo Nylon utilizzabile da 2,4 a 3,5 mm.
- Realizzata con materiali ad alta resistenza all'usura.
- Attacco universale affidabile e sicuro.
- Pomello di battuta in metallo montato su cuscinetto con funzionamento coppa folle.

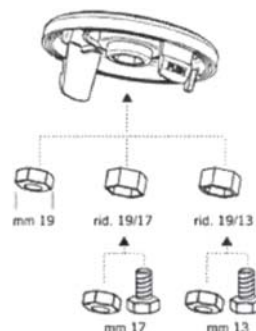

ARTICOLO  
**27013**

#### RICAMBI PER TESTINE COD. 27012 - 27013

PIECES DETACHEES POUR TETES  
SPARE PARTS FOR HEADS  
ERSATZTEILE FÜR FADENKÖPFE  
REPUESTOS PARA CABEZALES

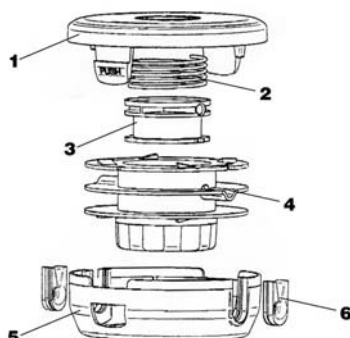

| RIF. FIGURA | DESCRIZIONE         | PER TESTINE  |              |
|-------------|---------------------|--------------|--------------|
|             |                     | 27012        | 27013        |
| 1           | Corpo superiore     | <b>27016</b> | <b>27016</b> |
| 2           | Molla               | <b>27017</b> | <b>27017</b> |
| 3           | Bicchierino         | <b>27018</b> | <b>27018</b> |
| 4           | Rocchetto portafilo | <b>27019</b> | <b>27020</b> |
| 5           | Corpo inferiore     | <b>27021</b> | <b>27021</b> |
| 6           | Boccole passafilo   | <b>26501</b> | <b>26501</b> |

**segue TESTINE PER DECESPUGLIATORI UNIVERSALE**

TETES DÉBROUSSAILLEUSES UNIVERSELLES - UNIVERSAL BRUSHCUTTER HEADS - FADENKÖPFE FÜR UNIVERSAL-MOTORSSENSE - CABEZALES PARA DESBROZADORAS UNIVERSAL

**TESTINA BATTI E VAI "FAST WORK" CON ATTACCO UNIVERSALE PROFESSIONALE**

TETE TAP AND GO "FAST WORK" A RACCORD UNIVERSEL PROFESSIONNELLE  
 "FAST WORK" PROFESSIONAL TAP'N GO HEAD WITH UNIVERSAL COUPLING  
 FADENKOPF TAP AND GO "FAST WORK" MIT PROFESSIONNELLEM UNIVERSALADAPTER  
 CABEZAL TAP & GO "FAST WORK" CON ACOPLAMIENTO UNIVERSAL SEMI PROFESIONAL



**CARATTERISTICHE**

- Testina compatta diametro 135 mm, estremamente robusta, con funzionamento Batti e Vai.
- Particolarmente indicata per un uso professionale.
- Possibilità di sostituzione filo a testina chiusa.
- Diametro filo Nylon utilizzabile da 2,4 a 4,0 mm.
- Realizzata con materiali ad alta resistenza all'usura.
- Attacco universale affidabile e sicuro.
- Pomello di battuta in Nylon.

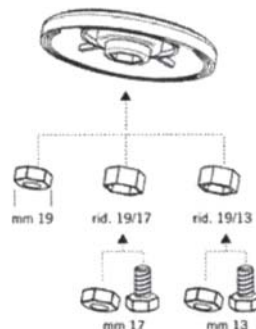

ARTICOLO  
**27014**

**TESTINA BATTI E VAI "FAST WORK" CON ATTACCO UNIVERSALE PROFESSIONALE CON COPPA FOLLE**

TETE TAP AND GO "FAST WORK" A RACCORD UNIVERSEL PROFESSIONNELLE A CARTER FOU  
 "FAST WORK" PROFESSIONAL TAP'N GO HEAD WITH UNIVERSAL COUPLING AND IDLE HOUSING  
 FADENKOPF TAP AND GO "FAST WORK" MIT PROFESSIONNELLEM UNIVERSALADAPTER MIT GLEITTELLER  
 CABEZAL TAP & GO "FAST WORK" CON ACOPLAMIENTO UNIVERSAL SEMI PROFESIONAL CON CUERPO LIBRE



**CARATTERISTICHE**

- Testina compatta diametro 135 mm, estremamente robusta, con funzionamento Batti e Vai.
- Particolarmente indicata per un uso professionale.
- Possibilità di sostituzione filo a testina chiusa.
- Diametro filo Nylon utilizzabile da 2,4 a 4,0 mm.
- Realizzata con materiali ad alta resistenza all'usura.
- Attacco universale affidabile e sicuro.
- Pomello di battuta in metallo montato su cuscinetto con funzionamento coppa folle.

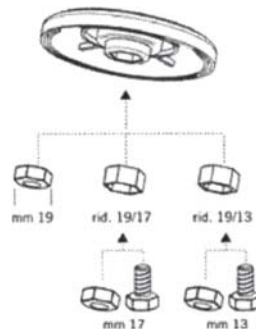

ARTICOLO  
**27015**

**RICAMBI PER TESTINE COD. 27014 - 27015**

PIECES DETACHEES POUR TETES  
 SPARE PARTS FOR HEADS  
 ERSATZTEILE FÜR FADENKÖPFE  
 REPUESTOS PARA CABEZALES

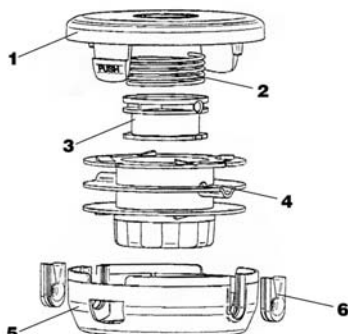

| RIF. FIGURA | DESCRIZIONE         | PER TESTINE  |              |
|-------------|---------------------|--------------|--------------|
|             |                     | 27014        | 27015        |
| 1           | Corpo superiore     | <b>27022</b> | <b>27022</b> |
| 2           | Molla               | <b>27017</b> | <b>27017</b> |
| 3           | Bicchierino         | <b>27023</b> | <b>27023</b> |
| 4           | Rocchetto portafilo | <b>27024</b> | <b>27025</b> |
| 5           | Corpo inferiore     | <b>26502</b> | <b>26502</b> |
| 6           | Boccole passafilo   | <b>26501</b> | <b>26501</b> |

### segue TESTINE PER DECESPUGLIATORI UNIVERSALE

TETES DÉBROUSSAILLEUSES UNIVERSELLES - UNIVERSAL BRUSHCUTTER HEADS - FADENKÖPFE FÜR UNIVERSAL-MOTORSENSE - CABEZALES PARA DESBROZADORAS UNIVERSAL

#### TESTINA MULTIFILI CON ATTACCO UNIVERSALE DA 2 A 12 FILI

TÊTE MULTIFIL A RACCORD UNIVERSEL DE 2 A 12 FILS  
2 TO 12-FLAIL MULTIPLE FLAIL HEAD WITH UNIVERSAL COUPLING  
MEHRFADENKOPF MIT UNIVERSAL-ADAPTER FÜR 2 BIS 12 FÄDEN  
CABEZAL MULTIPLE CON ACOPLAMIENTO UNIVERSAL DE 2 A 12 UNID.



FIG. 1



FIG. 2

#### CARATTERISTICHE

Testina di facile installazione su tutti i tipi di decespugliatori. Alta facilità di taglio con notevole risparmio di tempo e carburante.

#### Funzione SPAZZOLA



| ARTICOLO | MATERIALE | Ø FILO UTILIZZ  |
|----------|-----------|-----------------|
| 26866    | Alluminio | da 3,0 a 5,0 mm |
| 26091    | Nylon     | da 3,0 a 5,0 mm |

2

#### TESTINA IN ALLUMINIO MULTIFILI CON ATTACCO UNIVERSALE DA 2 A 6 FILI

TÊTE MULTIFIL A RACCORD UNIVERSEL DE 2 A 6 FILS  
2 TO 6-FLAIL MULTIPLE FLAIL HEAD WITH UNIVERSAL COUPLING  
MEHRFADENKOPF MIT UNIVERSAL-ADAPTER FÜR 2 BIS 6 FÄDEN  
CABEZAL MULTIPLE CON ACOPLAMIENTO UNIVERSAL DE 2 A 6 UNID.



| ARTICOLO | CARATTERISTICHE                             |
|----------|---|
| 27615    | Diametro filo utilizzabile da 2,7 a 3,5 mm. |

#### TESTINA H 57

TÊTE H57  
BRUSH CUTTER HEAD H57  
KANTENSCHNEIDER KOPT H57  
CABEZA H57

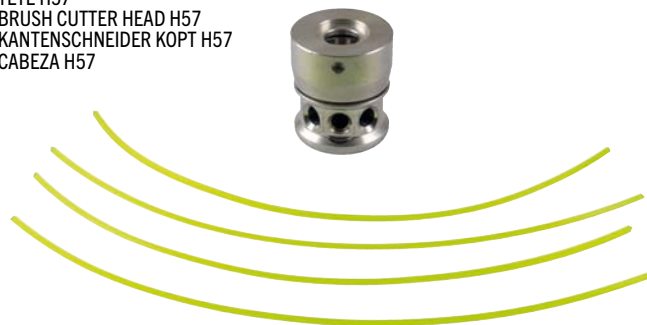

#### CARATTERISTICHE

- Testina multifilo in metallo.
- Diametro filo nylon utilizzabile da 3,0 a 5,0 mm.
- Fissaggio filo con vite laterale.

| ARTICOLO |
|----------|
| 27267    |

#### TESTINA IN ALLUMINIO ULTRALEGGERA ATTACCO UNIVERSALE

TÊTE EN ALUMINIUM ULTRALÈGÈRE AVEC ATTAQUE UNIVERSEL  
ULTRALIGHT UNIVERSAL COUPLING ALUMINIUM HEAD  
ALLUMINIUM KOPTF FUER KANTENSCHNEIDER  
CABEZA DE ALUMINIO ULTRALEGGERA CON ATAQUE UNIVERSAL



Grano monoblocco sostituibile.

Facilità nella sostituzione del filo.

Testina in alluminio.

| ARTICOLO | CARATTERISTICHE                  |
|----------|----------------------------------|
| 27268    | Diametro filo utilizzabile 3 mm. |

#### SPOLLONATORE PICCOLO Ø 100

TÊTE DÉBROUSSAILLEUSE PETIT Ø100  
SMALL BRUSH-CUTTER HEAD Ø100  
KANTENSCHNEIDER KOPF  
CABEZA PEQUEÑA PARA DESBROZADORA Ø100



| ARTICOLO | DESCRIZIONE                |
|----------|----------------------------|
| 27616    | SPOLLONATORE PICCOLO Ø 100 |
| 27617    | DISCO DI RICAMBIO Ø 100    |

### DISCO ANTI-INVOLGIMENTO ERBA "NINJA" PER DECESPUGLIATORE

DISQUE ANTI-ENROULEMENT HERBE "NINJA" POUR DÉBROUSSAILLEUSE  
 "NINJA" ANTI GRASS-WINDING DEVICE  
 "NINJA" GEGENVERBLUFFENNEN KANTENSCHNEIDERSCHEIBE  
 DISCO ANTI-DEVANADO HIERBA "NINJA" PARA DESBROZADORA



ARTICOLO  
**28011**

### DISCO ANTI-INVOLGIMENTO ERBA "NINJA" PROFESSIONALE

DISQUE ANTI-ENROULEMENT HERBE "NINJA" PROFESSIONNEL  
 PROFESSIONAL "NINJA" ANTI GRASS-WINDING DEVICE  
 "NINJA" GEGENVERBLUFFENNEN KANTENSCHNEIDERSCHEIBE  
 DISCO ANTI-DEVANADO HIERBA "NINJA" PROFESIONAL



ARTICOLO  
**28308**

### COPPA FISSA

CARTER FIXE  
 FIXED HOUSING  
 FESTER GLEITTELLER  
 CÁRTER FIJO



Ø COPPA = 80 mm  
 Ø FORO = 8 mm

ARTICOLO  
**26399**

### VITI

VIS  
 BOLTS  
 SCHRAUBEN  
 TORNILLOS



| ARTICOLO     | DESCRIZIONE |
|--------------|-------------|
| <b>26474</b> | 7x1 Sx.     |
| <b>26475</b> | 8x1,25 Sx.  |
| <b>26476</b> | 10x1,25 Sx. |
| <b>26477</b> | 10x1,5 Sx.  |

### DADI

ECROUS  
 NUTS  
 MUTTERN  
 TUERCAS



| ARTICOLO     | DESCRIZIONE |
|--------------|-------------|
| <b>26478</b> | 8x1,25 Sx.  |
| <b>26479</b> | 10x1 Sx.    |
| <b>26480</b> | 10x1,25 Sx. |
| <b>26481</b> | 10x1,5 Sx.  |
| <b>26482</b> | 12x1,5 Sx.  |
| <b>26483</b> | 12x1,75 Sx. |

### KIT VITI E DADI

KIT VIS ET ECROUS  
 BOLT AND NUT KIT  
 SATZ MIT SCHRAUBEN UND MUTTERN  
 KIT TORNILLOS Y TUERCAS

#### COMPOSTO DA:

- 10 pz. Vite 7x1,00
- 10 pz. Vite 8x1,25
- 10 pz. Vite 10x1,25
- 10 pz. Vite 10x1,50
- 10 pz. Dado+rondella 8x1,25
- 10 pz. Dado 10x1,00
- 10 pz. Dado 10x1,25
- 10 pz. Dado 10x1,50
- 10 pz. Dado 12x1,50
- 10 pz. Dado 12x1,75



ARTICOLO  
**26488**

### KIT LAME PER ROBOT AUTOMATICI

LAMES POUR ROBOTS AUTOMATIQUES  
 KIT BLADES FOR AUTOMATIC ROBOTS  
 MESSERKLINGEN ROBOT MIT SCHRAUBEN  
 KIT CUCHILLAS PARA ROBOT

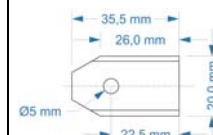

ARTICOLO  
**46247**



16

### DISCO A 2 DENTI

DISQUE A 2 DENTS  
CUTTER BLADE WITH 2 TEETH  
2-ZAHN-METALLBLATT  
DISCO DE 2 DIENTES

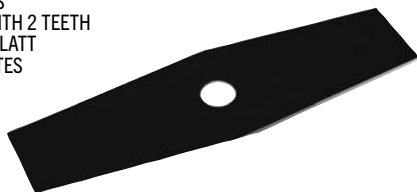

| ARTICOLO     | DESCRIZIONE       |
|--------------|-------------------|
| <b>26489</b> | Ø 255 - sp.1,6 mm |
| <b>26490</b> | Ø 305 - sp.1,6 mm |

### DISCO A 2 DENTI

DISQUE A 2 DENTS  
CUTTER BLADE WITH 2 TEETH  
2-ZAHN-METALLBLATT  
DISCO DE 2 DIENTES



| ARTICOLO     | DESCRIZIONE       |
|--------------|-------------------|
| <b>26821</b> | Ø 305 - sp.3,0 mm |

### DISCO A 3 DENTI

DISQUE A 3 DENTS COURBES  
CUTTER BLADE WITH 3 CURVED TEETH  
3-ZAHN-METALLBLATT  
DISCO DE 3 DIENTES CURVOS



| ARTICOLO     | DESCRIZIONE       |
|--------------|-------------------|
| <b>26830</b> | Ø 255 - sp.1,4 mm |

### DISCO A 8 DENTI

DISQUE A 8 DENTS  
CUTTER BLADE WITH 8 TEETH  
8-ZAHN-METALLBLATT  
DISCO DE 8 DIENTES



| ARTICOLO     | DESCRIZIONE       |
|--------------|-------------------|
| <b>26832</b> | Ø 255 - sp.1,4 mm |

### DISCO A 2 DENTI

DISQUE A 2 DENTS  
CUTTER BLADE WITH 2 TEETH  
2-ZAHN-METALLBLATT  
DISCO DE 2 DIENTES



| ARTICOLO     | DESCRIZIONE       |
|--------------|-------------------|
| <b>26491</b> | Ø 250 - sp.3,0 mm |
| <b>26492</b> | Ø 300 - sp.3,0 mm |

### DISCO A 3 DENTI

DISQUE A 3 DENTS COURBES  
CUTTER BLADE WITH 3 CURVED TEETH  
3-ZAHN-METALLBLATT  
DISCO DE 3 DIENTES CURVOS



| ARTICOLO     | DESCRIZIONE       |
|--------------|-------------------|
| <b>26494</b> | Ø 260 - sp.3,0 mm |
| <b>26495</b> | Ø 300 - sp.3,0 mm |

### DISCO A 4 DENTI

DISQUE A 4 DENTS  
CUTTER BLADE WITH 4 TEETH  
4-ZAHN-METALLBLATT  
DISCO DE 4 DIENTES

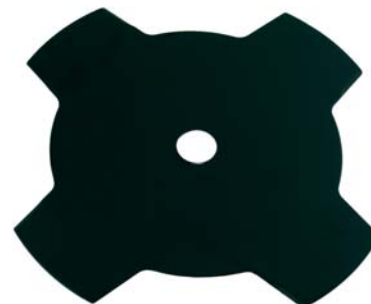

| ARTICOLO     | DESCRIZIONE       |
|--------------|-------------------|
| <b>26831</b> | Ø 255 - sp.1,4 mm |

### DISCO A SEGA

DISQUE A SCIE  
SAW-TOOTH CUTTER BLADE  
SÄGEBLATT  
DISCO DE SIERRA



| ARTICOLO     | DESCRIZIONE       |
|--------------|-------------------|
| <b>26834</b> | Ø 255 - sp.1,6 mm |



### DISCO A 2 DENTI

DISQUE A 2 DENTS  
CUTTER BLADE WITH 2 TEETH  
2-ZAHN-METALLBLATT  
DISCO DE 2 DIENTES

new

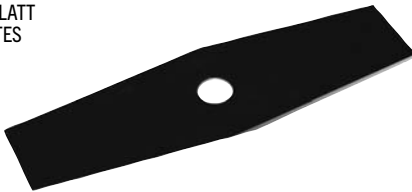

| ARTICOLO     | DESCRIZIONE       |
|--------------|-------------------|
| <b>28453</b> | Ø 305 - sp.1,6 mm |

### DISCO A 2 DENTI

DISQUE A 2 DENTS  
CUTTER BLADE WITH 2 TEETH  
2-ZAHN-METALLBLATT  
DISCO DE 2 DIENTES

new



| ARTICOLO     | DESCRIZIONE       |
|--------------|-------------------|
| <b>28454</b> | Ø 300 - sp.3,0 mm |

### DISCO A 2 DENTI

DISQUE A 2 DENTS  
CUTTER BLADE WITH 2 TEETH  
2-ZAHN-METALLBLATT  
DISCO DE 2 DIENTES

new



| ARTICOLO     | DESCRIZIONE       |
|--------------|-------------------|
| <b>28455</b> | Ø 305 - sp.3,0 mm |

### DISCO A 40 DENTI

DISQUE À 40 DENTS  
40-TOOTH DISC  
SCHEIBE MIT 40 ZÄHNEN  
DISCO DE 40 DIENTES

new



| ARTICOLO     | DESCRIZIONE     |
|--------------|-----------------|
| <b>28457</b> | Ø 255 - sp.2 mm |

### DISCO A 2 DENTI SEGHETTATO

DISQUE À 2 DENTS CRANTÉ  
2-TOOTH SERRATED DISC  
GEZACKTE SCHEIBE MIT 2 ZÄHNEN  
DISCO DE 2 DIENTES ASERRADO

new



| ARTICOLO     | DESCRIZIONE       |
|--------------|-------------------|
| <b>28458</b> | Ø 300 - sp.2,0 mm |

### DISCO MACINONE

DISQUE BROYEUSE  
CRUSHER BLADE DISC  
SCHEIBE FÜR BÜRSTENMÄHER  
DISCO MOLEDOR

new



| ARTICOLO     | DESCRIZIONE       |
|--------------|-------------------|
| <b>28456</b> | Ø 255 - sp.3,0 mm |

### DISCO A 36 DENTI WIDIA

DISQUE A 36 DENTS WIDIA  
CUTTER BLADE WITH 36 TEETH IN WIDIA  
36-ZAHN-METALLBLATT WIDIA  
DISCO DE 36 DIENTES WIDIA

MADE IN JAPAN



| ARTICOLO     | DESCRIZIONE       |
|--------------|-------------------|
| <b>26833</b> | Ø 255 - sp.2,0 mm |

### DISCO A 40 DENTI AL TUNGSTENO

DISQUE À 40 DENTS EN TUNGSTÈNE  
TUNGSTEN 40 TEETH DISC  
40 ZÄHNE SCHEIBE AUS WOLFRAM  
DISCO DE GRADA DENTADO, 40 DIENTES, EN TUNGSTENO



| ARTICOLO     | DESCRIZIONE     |
|--------------|-----------------|
| <b>27618</b> | Ø 255x2x25,4 mm |

### ACCESSORI PER DECESPUGLIATORI

ACCESSOIRES POUR DEBROUSSAILLEUSES - ACCESSORIES FOR STRIMMERS - ZUBEHOER FÜR FREISCHNEIDER - ACCESORIOS PARA DESMALEZADORAS

#### VISIERA IN RETE METALLICA ANTIRIFLESSO

VISIÈRE A GRILLE MÉTALLIQUE ANTIREFLET  
VISOR IN NON-REFLECTING METAL GAUZE  
GESICHTSSCHUTZ AUS METALLGITTER MIT BLENDSCHUTZ  
VISERA DE RED METÁLICA ANTIRREFLEJO



ARTICOLO  
**26011**

#### VISIERA IN POLICARBONATO ANTIRIFLESSO

VISIÈRE EN POLYCARBONATE ANTIREFLET  
VISOR IN NON-REFLECTING POLYCARBONATE  
GESICHTSSCHUTZ AUS POLYCARBONAT, BLENDSCHUTZ  
VISERA DE POLICARBONATO ANTIRREFLEJO



ARTICOLO  
**26389**

#### VISIERA IN RETE METALLICA E POLICARBONATO, ANTIRIFLESSO

VISIÈRE A GRILLE MÉTALLIQUE ET POLYCARBONATE, ANTIREFLET  
VISOR IN POLYCARBONATE AND METAL GAUZE, NON-REFLECTING  
GESICHTSSCHUTZ AUS METALLGITTER UND POLYCARBONAT MIT BLENDSCHUTZ  
VISERA DE RED METÁLICA Y POLICARBONATO, ANTIRREFLEJO



ARTICOLO  
**26390**

#### VISIERA IN RETE METALLICA ANTIRIFLESSO CON CALOTTA PROTETTIVA

VISIÈRE A GRILLE MÉTALLIQUE ANTIREFLET AVEC CALOTTE DE PROTECTION  
VISOR IN NON-REFLECTING METAL GAUZE WITH PROTECTIVE TOP  
GESICHTSSCHUTZ AUS METALLGITTER MIT BLENDSCHUTZ UND STIRNSCHUTZ  
VISERA DE RED METÁLICA ANTIRREFLEJO CON CÁRTER DE PROTECCIÓN



ARTICOLO  
**26391**

#### VISIERA IN POLICARBONATO ANTIRIFLESSO CON CALOTTA PROTETTIVA

VISIÈRE EN POLYCARBONATE ANTIREFLET AVEC CALOTTE DE PROTECTION  
VISOR IN NON-REFLECTING POLYCARBONATE WITH PROTECTIVE TOP  
GESICHTSSCHUTZ AUS POLYCARBONAT MIT BLENDSCHUTZ UND STIRNSCHUTZ  
VISERA DE POLICARBONATO ANTIRREFLEJO CON CÁRTER DE PROTECCIÓN



ARTICOLO  
**26392**



10  
VISIERE OMOLOGATE CON IL  
NUOVO REGOLAMENTO  
(UE) 2016/425  
CHE SOSTITUISCE LA VECCHIA  
DIRETTIVA 89/686/CEE

# Agricoltura e Giardinaggio

## AGRICULTURE & GARDENING

16

### segue ACCESSORI PER DECESPUGLIATORI

ACCESSOIRES POUR DEBROUSSAILLEUSES - ACCESSORIES FOR STRIMMERS - ZUBEHOER FÜR FREISCHNEIDER - ACCESORIOS PARA DESMALEZADORAS

#### **VISIERA IN RETE METALLICA E POLICARBONATO, ANTIRIFLESSO CON CALOTTA PROTETTIVA**

VISIERE A GRILLE MÉTALLIQUE ET POLYCARBONATE, ANTIREFLET AVEC CALOTTE DE PROTECTION  
VISOR IN NON-REFLECTING METAL GAUZE AND POLYCARBONATE WITH PROTECTIVE TOP  
GESICHTSSCHUTZ AUS METALLGITTER UND POLYCARBONAT MIT BLENDSCHUTZ UND STIRNSCHUTZ  
VISERA DE RED METÁLICA Y POLICARBONATO, ANTIRREFLEJO CON CÁRTER DE PROTECCIÓN

 **MADE IN ITALY**



ARTICOLO  
**26393**

#### **VISIERA IN RETE METALLICA ANTIRIFLESSO CON CALOTTA PROTETTIVA E REGOLAZIONE A POMELLO**

VISIERE A GRILLE MÉTALLIQUE ANTIREFLET AVEC CALOTTE DE PROTECTION ET RÉGLAGE A POMMEAU  
VISOR IN NON-REFLECTING METAL GAUZE WITH PROTECTIVE TOP AND ADJUSTER KNOB  
GESICHTSSCHUTZ AUS METALLGITTER MIT BLENDSCHUTZ UND STIRNSCHUTZ, EINSTELLBAR  
VISERA DE RED METÁLICA ANTIRREFLEJO CON CÁRTER DE PROTECCIÓN Y REGULACIÓN CON PERILLA



 **MADE IN ITALY**



ARTICOLO  
**26835**

#### **VISIERA IN POLICARBONATO ANTIRIFLESSO CON CALOTTA PROTETTIVA E REGOLAZIONE A POMELLO**

VISIERE EN POLYCARBONATE ANTIREFLET AVEC CALOTTE DE PROTECTION ET RÉGLAGE A POMMEAU  
VISOR IN NON-REFLECTING POLYCARBONATE WITH PROTECTIVE TOP AND ADJUSTER KNOB  
GESICHTSSCHUTZ AUS POLYCARBONAT MIT BLENDSCHUTZ UND STIRNSCHUTZ, EINSTELLBAR  
VISERA DE POLICARBONATO ANTIRREFLEJO CON CÁRTER DE PROTECCIÓN Y REGULACIÓN CON PERILLA



 **MADE IN ITALY**



ARTICOLO  
**26836**

#### **VISIERA IN RETE METALLICA E POLICARBONATO, ANTIRIFLESSO CON CALOTTA PROTETTIVA E REGOLAZIONE A POMELLO**

VISIERE A GRILLE MÉTALLIQUE ET POLYCARBONATE, ANTIREFLET AVEC CALOTTE DE PROTECTION ET RÉGLAGE A POMMEAU  
VISOR IN NON-REFLECTING METAL GAUZE AND POLYCARBONATE WITH PROTECTIVE TOP AND ADJUSTER KNOB  
GESICHTSSCHUTZ AUS METALLGITTER UND POLYCARBONAT MIT BLENDSCHUTZ UND STIRNSCHUTZ, EINSTELLBAR  
VISERA DE RED METÁLICA Y POLICARBONATO, ANTIRREFLEJO CON CÁRTER DE PROTECCIÓN Y REGULACIÓN CON PERILLA



 **MADE IN ITALY**



ARTICOLO  
**26837**

#### **ELMETTO FORESTALE COMPLETO DI CUFFIE E VISIERA IN RETE**

CASQUE FORESTIER AVEC ANTI BRUIT ET VISIERE EN GRILLE  
HELMET FOR FORESTRY WORK COMPLETE WITH EAR MUFFS AND GAUZE VISOR  
HELMSET FÜR WALDARBEITER KOMPLETT MIT GEHÖRSCHUTZ UND GITTERGESICHTSSCHUTZ  
CASCO FORESTAL CON OREJERAS Y VISERA DE RED



ARTICOLO  
**26838**

### segue ACCESSORI PER DECESPUGLIATORI

ACCESSOIRES POUR DEBROUSSAILLEUSES - ACCESSORIES FOR STRIMMERS - ZUBEHOER FÜR FREISCHNEIDER - ACCESORIOS PARA DESMALEZADORAS

#### ELMETTO FORESTALE G3000 3M COMPLETO DI CUFFIE E VISIERA IN RETE

CASQUE FORESTIER AVEC ANTI BRUIT ET VISIERE EN GRILLE - G3000 3M  
 HELMET FOR FORESTRY WORK COMPLETE WITH EAR MUFFS AND GAUZE VISOR - G3000 3M  
 HELMSET FÜR WALDARBEITER KOMPLETT MIT GEHÖRSCHUTZ UND GITTERGESICHTSSCHUTZ - G3000 3M  
 CASCO FORESTAL CON OREJERAS Y VISERA DE RED - G3000 3M

# 3M



ARTICOLO  
**28357**

new

#### VISIERA DI RICAMBIO A RETE IN ACCIAIO INOX 3M

VISIÈRE DE RECHANGE EN MAILLE D'ACIER INOX 3M  
 STAINLESS STEEL MESH SPARE VISOR 3M  
 ERSATZVISIER AUS NETZ IN EDELSTAHL 3M  
 VISERA DE REPUESTO DE MALLA DE ACERO INOXIDABLE 3M



ARTICOLO  
**28358**

#### BRETELLA PROFESSIONALE A ZAINO

HARNAIS PROFESSIONNEL À SAC-AU-DOS  
 PROFESSIONAL BACKPACK STRAP  
 ARMBAND FUER KANTENSCHNEIDER  
 TIRANTE PROFESIONAL À MOCHILA

**MADE IN ITALY**



ARTICOLO  
**27702**

#### BRETELLA STANDARD

HARNAIS STANDARD  
 STANDARD STRAP  
 STANDARDTRAGEGURT  
 TIRANTE STANDARD

**MADE IN ITALY**



ARTICOLO  
**26394**

#### BRETELLA PROFESSIONALE

HARNAIS PROFESSIONNEL  
 PROFESSIONAL STRAP  
 PROFESSIONELLER TRAGEGURT  
 TIRANTE PROFESIONAL

**MADE IN ITALY**



ARTICOLO  
**26395**

#### BRETELLA PROFESSIONALE CONFORT

HARNAIS PROFESSIONNEL CONFORT  
 "CONFORT" PROFESSIONAL STRAP  
 PROFESSIONELLER KOMFORTTRAGEGURT  
 TIRANTE PROFESIONAL CONFORT

**MADE IN ITALY**



ARTICOLO  
**26396**

segue **ACCESSORI PER DECESPUGLIATORI**

ACCESSOIRES POUR DEBROUSSAILLEUSES - ACCESSORIES FOR STRIMMERS - ZUBEHOER FÜR FREISCHNEIDER - ACCESORIOS PARA DESMALEZADORAS

**GAMBALI DI PROTEZIONE**JAMBIERES DE PROTECTION  
SHIN GUARDS  
BEINSCHUTZ  
CANILLERAS DE PROTECCIÓN

| ARTICOLO     | CARATTERISTICHE  |
|--------------|--|
| <b>26867</b> | Costruiti in materiale estremamente robusto. Pratici da indossare. |

**GAMBALE DI PROTEZIONE IMBOTTITO 10 MM**GUËTRES (10 mm ÉPAISSEUR)  
LEGS' GAITERS (10 mm THICKNESS)  
BEINESGAMASCHEN (10 mm DICKE)  
DELANTAL PARA PIERNAS (10 mm GRUESA)ARTICOLO  
**27355****COPRI PANTALONE PROTETTIVO TAGLIA UNICA**HOUSSE DE PANTALON DE PROTECTION TAILLE UNIQUE  
ONE-SIZE PROTECTIVE TROUSERS COVER  
HOSENSCHÖNER IN EINHEITSGRÖSSE  
CUBRE PANTALÓN DE PROTECCIÓN TALLA ÚNICA

| ARTICOLO     | CARATTERISTICHE   |
|--------------|---|
| <b>28460</b> | Tessuto ad alta visibilità e ad alta resistenza a tagli o strappi. Taglia unica regolabile. |

**GAMBALI DI PROTEZIONE RIGIDI IN POLICARBONATO**JAMBIERES DE PROTECTION RIGIDES EN POLYCARBONATE  
RIGID SHIN GUARDS IN POLYCARBONATE  
STARRER BEINSCHUTZ AUS POLYCARBONAT  
CANILLERAS DE PROTECCIÓN RÍGIDAS EN POLYCARBONATO

| ARTICOLO     | CARATTERISTICHE   |
|--------------|---|
| <b>27097</b> | Gambale in polycarbonato con regolazione e chiusura laterale ad incastro. |

**PETTORINA IN COTONE CON PROTEZIONE**SALOPETTE DE PROTECTION EN COTON  
COTTON SHIELD DUNGAREES  
BAUMWOLLE SCHUTZ LATZHOSE  
PETO DE PROTECTION EN ALGODÓN

| ARTICOLO     | TAGLIA |
|--------------|--------|
| <b>27356</b> | M      |
| <b>27357</b> | L      |
| <b>27358</b> | XL     |
| <b>27359</b> | XXL    |

**PANTALONE IMPERMEABILE TAGLIA UNICA**PANTALON IMPERMEABLE TAILLE UNIQUE  
WATERPROOF PANTS - ONE SIZE  
WASSERDICHTE ARBEITSHOSE EINHEITSGRÖSSE  
PANTALON IMPERMEABLE TALLE UNICOARTICOLO  
**26763**

### segue ACCESSORI PER DECESPUGLIATORI

ACCESSOIRES POUR DEBROUSSAILLEUSES - ACCESSORIES FOR STRIMMERS - ZUBEHOER FÜR FREISCHNEIDER - ACCESORIOS PARA DESMALEZADORAS

#### GREMBIULE PROTETTIVO

TABLIER DE PROTECTION  
PROTECTIVE APRON  
SCHUTZSCHÜRZE  
BATA DE PROTECCIÓN



#### GREMBIULE IMPERMEABILE TAGLIA UNICA

TABLIER IMPERMEABLE TAILLE UNIQUE  
WATERPROOF APRON - ONE SIZE  
WASSERDICHTE SCHÜRZE EINHEITSGRÖSSE  
BATA IMPERMEABLE TALLE UNICO



| ARTICOLO     | CARATTERISTICHE  |
|--------------|--|
| <b>26397</b> | Il grembiule ha un'ampia superficie protettiva contro qualsiasi tipo di oggetto. Costruito in materiale estremamente robusto. Leggero e traspirante. Pratico da indossare. |

| ARTICOLO     |
|--------------|
| <b>26764</b> |

#### GREMBIULE PROTETTIVO LUNGO IN TESSUTO AD ALTA RESISTENZA

TABLIER DE PROTECTION  
PROTECTIVE APRON  
SCHUTZSCHÜRZE  
BATA DE PROTECCIÓN

new



#### GREMBIULE MULTIUSO

TABLIER MULTI-USAGE  
ALL-PURPOSE APRON  
MEHRZWECKSCHÜRZE  
BATA MULTIUSO



| ARTICOLO     | CARATTERISTICHE   |
|--------------|---|
| <b>28459</b> | Ampia tasca portaoggetti. Pratici sistemi di regolazione. |

| ARTICOLO     |
|--------------|
| <b>26765</b> |

#### MARSUPIO GIARDINAGGIO

SAC BANANE JARDINAGE  
GARDENING POUCH  
BAUCHTASCHE FÜR GARTENARBEIT  
RIÑONERA JARDINERÍA



| ARTICOLO     |
|--------------|
| <b>26766</b> |

### FORBICE VIGNA PROFESSIONALE

SÉCATEUR VIGNE PROFESSIONNEL  
PROFESSIONAL VINE PRUNING SHEARS  
PROFESSIONELLE WEINBERGSCHERE  
TIJERA VIÑA PROFESIONAL



| ARTICOLO     | DESCRIZIONE                    | ART. AUSONIA |
|--------------|--------------------------------|--------------|
| <b>78001</b> | FORB VIGNA PROF.cm21 LAME FORG | 081003       |

#### Ricambi

|              |                                    |        |
|--------------|------------------------------------|--------|
| <b>78002</b> | LAMA FORGIATA RICAM. ART. 78001    | 081026 |
| <b>78003</b> | CONTROLAMA FORG. RICAM. X 78001    | 081027 |
| <b>78006</b> | MOLLA RICAM.X 78001                | 081031 |
| <b>78007</b> | KIT DADO + FERMO + AMMORT. X 78001 | 081049 |

### FORBICE DA VIGNA FORGIATA PROFESSIONALE - SPALLA LUCIDA

SÉCATEUR POUR FRUITIERS PROFESSIONNEL ET LAME A BATTANT  
PROFESSIONAL FORGED ANVIL VINE PRUNING SHEARS  
PROFESSIONELLE OBSTSCHERE MIT KRAFTAMBOSS  
TIJERA PARA FRUTEROS PROFESIONAL HOJA DE BATIENTE



| ARTICOLO     | DESCRIZIONE                 | ART. AUSONIA |
|--------------|-----------------------------|--------------|
| <b>78018</b> | FORBICE VIGNA cm 21 BREVETT | 031003       |
| <b>78019</b> | FORBICE VIGNA cm 23 BREVETT | 031006       |

#### Ricambi

|              |                                     |        |
|--------------|-------------------------------------|--------|
| <b>78013</b> | MOLLA F.VIGNA cm 21                 | 036003 |
| <b>78020</b> | MOLLA F.VIGNA cm 23                 | 036004 |
| <b>78021</b> | BULLONE F.VIGNA NICH 21 + FERMADADO | 036509 |
| <b>78022</b> | BULLONE F.VIGNA NICH 23 + FERMADADO | 036510 |

### FORBICE DA VIGNA PROFESSIONALE PATIN 3 - PATIN 6

SÉCATEUR DE VIGNE PROFESSIONNEL PATIN 3 - PATIN 6  
PATIN 3 - PATIN 6 PROFESSIONAL VINE PRUNING SHEARS  
PROFESSIONELLE WEINBERGSCHERE PATIN 3 - PATIN 6  
TIJERA PARA VIÑA FORJADA PROFESIONAL PATIN 3 - PATIN 6



| ARTICOLO     | DESCRIZIONE        | ART. AUSONIA |
|--------------|--------------------|--------------|
| <b>78029</b> | FORB VIGNA PATIN 6 | 031136       |

#### Ricambi

|              |                                 |        |
|--------------|---------------------------------|--------|
| <b>78031</b> | MOLLA RICAMBIO X 78028 - 78029  | 036077 |
| <b>78032</b> | GANCIO CHIUSURA X 78028 - 78029 | 036201 |
| <b>78033</b> | KIT FERMADADO+BULLONE+GANCIO    | 036523 |
| <b>78034</b> | FERMADADO X ART 78028 - 78029   | 036203 |
| <b>78035</b> | 0 LAMA RICAMBIO 78029           | 036147 |
| <b>78036</b> | BATTENTE+VITE RICAM.X 78029     | 036206 |

### FORBICE PER FRUTTETI PROFESSIONALE LAMA A BATTENTE

SÉCATEUR DE VIGNE FORGÉE PROFESSIONNEL - POIGNEE POLIE  
PROFESSIONAL FORGED VINE PRUNING SHEARS - POLISHED FINISH  
PROFESSIONELLE WEINBERGSCHERE GEBOGEN, GLÄNZEND  
TIJERA PARA VIÑA FORJADA PROFESIONAL - LATERAL PULIDO



| ARTICOLO     | DESCRIZIONE                | ART. AUSONIA |
|--------------|----------------------------|--------------|
| <b>78012</b> | FORB FRUTTETI M/PLAST CM21 | 031110       |

#### Ricambi

|              |                                 |        |
|--------------|---------------------------------|--------|
| <b>78013</b> | MOLLA F.VIGNA cm 21             | 036003 |
| <b>78014</b> | RULLO FERRO PER FORBICI + PERNO | 036050 |
| <b>78016</b> | SERIE ACC X CHIUS BREV.         | 036080 |
| <b>78017</b> | BULLONE COMPLETO ART.78012      | 036405 |

### FORBICE DA VIGNA PROFESSIONALE

SÉCATEUR VIGNE PROFESSIONNEL  
PROFESSIONAL VINE PRUNING SHEARS  
PROFESSIONELLE WEINBERGSCHERE  
TIJERA PARA VIÑA PROFESIONAL



| ARTICOLO     | DESCRIZIONE            | ART. AUSONIA |
|--------------|------------------------|--------------|
| <b>78025</b> | FORB VIGNA ALLUM.FORG. | 031070       |

#### Ricambi

|              |                              |        |
|--------------|------------------------------|--------|
| <b>78026</b> | LAMA RICAMBIO X ART.78025    | 036131 |
| <b>78027</b> | MOLLA RICAMBIO PER ART.78025 | 036076 |

### FORBICE DA VIGNA

SÉCATEUR VIGNE  
VINE PRUNING SHEARS  
WEINBERGSCHERE  
TIJERA PARA VIÑA



| ARTICOLO     | DESCRIZIONE               | ART. AUSONIA |
|--------------|---------------------------|--------------|
| <b>78037</b> | FORB VIGNA SPECIALE cm 23 | 031150       |

#### Ricambi

|              |                                    |        |
|--------------|------------------------------------|--------|
| <b>78038</b> | MOLLA RICAMBIO ART. 78037          | 036189 |
| <b>78039</b> | DADO + BULLONE RICAMBIO ART. 78037 | 036190 |
| <b>78040</b> | FERMO CHIUSURA ART. 78037          | 036191 |
| <b>78041</b> | LAMA RICAMBIO FORBICI 78037        | 036188 |



16

### FORBICE DA VIGNA EVO 2

SÉCATEUR VIGNE EVO 2  
EVO 2 VINE PRUNING SHEARS  
EVO 2 WEINBERGSCHERE  
TIJERA PARA VIÑA EVO 2



| ARTICOLO     | DESCRIZIONE            | ART. AUSONIA |
|--------------|------------------------|--------------|
| <b>78178</b> | FORBICE DA VIGNA EVO 2 | 31082        |

#### Ricambi

|              |  |       |
|--------------|--|-------|
| <b>78179</b> | LAMA RICAMBIO                                      | 36482 |
| <b>78180</b> | KIT 2 MOLLE + 2 AMMORTIZZATORI                     | 36472 |
| <b>78181</b> | KIT GANCIO + CHIUSURA BULLONE + CENTRALE FERMADADO | 36471 |

### FORBICE DA VIGNA

SÉCATEUR VIGNE  
VINE PRUNING SHEARS  
WEINBERGSCHERE  
TIJERA PARA VIÑA



| ARTICOLO     | DESCRIZIONE             | ART. AUSONIA |
|--------------|-------------------------|--------------|
| <b>78043</b> | FORBICE VIGNA ALLUMINIO | 031065       |

#### Ricambi

|              |                           |        |
|--------------|---------------------------|--------|
| <b>78044</b> | MOLLA RICAMBIO ART. 78043 | 036040 |
| <b>78045</b> | LAMA RICAMBIO X ART.78043 | 036132 |

### TENAGLIETTA PER AGRUMI

SÉCATEUR POUR AGRUMES  
SHEARS FOR CITRUS FRUIT CROPS  
SCHERE FÜR ZITRUSFRÜCHTE  
TENAZA PARA CÍTRICOS



| ARTICOLO     | DESCRIZIONE        | ART. AUSONIA |
|--------------|--------------------|--------------|
| <b>78054</b> | TENAGLIETTA AGRUMI | 031410       |

#### Ricambi

|              |                          |        |
|--------------|--------------------------|--------|
| <b>78055</b> | MOLLA RICAMBIO FCI 78054 | 036710 |
|--------------|--------------------------|--------|

### FODERO PER FORBICI E SEGHETTI

#### PIETRE PER AFFILARE

ETUI EN NYLON POUR SÉCATEUR VIGNE ET SCIES. PIERRES A AFFUTER  
NYLON CASE FOR VINE PRUNING SHEARS AND SAWS HONING STONES  
NYLONHÜLLE FÜR WEINBERGSCHERE UND BÜGELSÄGEN ABZIEHSTEINE  
FUNDA DE NAILON PARA TIJERAS DE VIÑA Y SIERRAS. PIEDRAS PARA AFILAR

| ARTICOLO     | DESCRIZIONE                     | FIG. | ART. AUSONIA |
|--------------|---------------------------------|------|--------------|
| <b>78046</b> | FODERO NYLON DOPPIA TASCA       | 1    | 029380       |
| <b>78167</b> | FODERO IN PELLE                 | 4    | -            |
| <b>78047</b> | PIETRA X AFFIL.FORB.VIGNA SINT. | 2    | 036302       |
| <b>78048</b> | PIETRA X AFFIL.FORB.VIGNA NAT.  | 3    | 036303       |

### FORBICE DA VIGNA EVO 6

SÉCATEUR VIGNE EVO 6  
EVO 6 VINE PRUNING SHEARS  
EVO 6 WEINBERGSCHERE  
TIJERA PARA VIÑA EVO 6



| ARTICOLO     | DESCRIZIONE            | ART. AUSONIA |
|--------------|------------------------|--------------|
| <b>78182</b> | FORBICE DA VIGNA EVO 6 | 31086        |

#### Ricambi

|              |  |       |
|--------------|--|-------|
| <b>78183</b> | LAMA RICAMBIO                                      | 36486 |
| <b>78184</b> | BATTENTE RICAMBIO                                  | 36476 |
| <b>78180</b> | KIT 2 MOLLE + 2 AMMORTIZZATORI                     | 36472 |
| <b>78181</b> | KIT GANCIO + CHIUSURA BULLONE + CENTRALE FERMADADO | 36471 |

### FORBICE COGLIUVA

CISEAUX A RAISIN  
GRAPE SHEARS  
REBSCHERE  
TIJERA COSECHA UVA



| ARTICOLO     | DESCRIZIONE                    | ART. AUSONIA |
|--------------|--------------------------------|--------------|
| <b>78051</b> | FORB COGLIUVA IX cm 19 BLISTER | 031325       |

#### Ricambi

|              |                      |        |
|--------------|----------------------|--------|
| <b>78052</b> | MOLLA RIC ART.78051  | 036034 |
| <b>78053</b> | BULLONE X FORB.78051 | 036052 |

### FORBICE COGLIUVA STANDARD

CISEAUX A RAISIN STANDARD  
STANDARD GRAPE SHEARS  
STANDARDREBSCHERE  
TIJERA COSECHA UVA ESTÁNDAR



| ARTICOLO     | DESCRIZIONE             | ART. AUSONIA |
|--------------|-------------------------|--------------|
| <b>78057</b> | FORB COGLIUVA cm 19 STD | 031327       |

#### Ricambi

|              |                           |        |
|--------------|---------------------------|--------|
| <b>78058</b> | MOLLA RIC.X 78057 - 78059 | 036048 |
|--------------|---------------------------|--------|



**FORBICE PER GIARDINO**

 SÉCATEUR JARDINAGE  
 GARDEN SHEARS  
 GARTENSCHERE  
 TIJERA PARA JARDINERÍA

| ARTICOLO     | DESCRIZIONE                | ART. AUSONIA |
|--------------|----------------------------|--------------|
| <b>78059</b> | FORB GIARDINO IX MCO PLAST | 035032       |

**Ricambi**

|              |                           |        |
|--------------|---------------------------|--------|
| <b>78058</b> | MOLLA RIC.X 78057 - 78059 | 036048 |
|--------------|---------------------------|--------|

**FORBICI DA SIEPI**

 TAILLE-HAIES  
 HEDGE SHEARS  
 HECKENSCHERE  
 TIJERA PARA SETOS

FIG. 2

FIG. 1

| ARTICOLO     | DESCRIZIONE                            | ART. AUSONIA |
|--------------|--|--------------|
| <b>78062</b> | FORB SIEPI ONDULATE MCI ALLUM. - FIG.1 | 031217       |
| <b>78063</b> | FORB SIEPI PROF.TELESCOPICHE - FIG.2   | 031215       |

**Ricambi**

|              |                             |        |
|--------------|-----------------------------|--------|
| <b>78064</b> | VITE A POMELLO X ART. 78062 | 036087 |
| <b>78177</b> | VITE A POMELLO X ART. 78063 | 036083 |

**TRONCARAMI TELESCOPICO A CRICCHETTO CON TAGLIO A BATTENTE**

 COUPE-BRANCHES TÉLESCOPIQUE A CLIQUET AVEC CRÉMAILLÈRE  
 TELESCOPIC RATCHET ANVIL LOPPING SHEAR  
 TELESKOP-KOMPASSASTSCHERE MIT KNARRENMECHANISMUS  
 CORTADORA DE RAMAS TELESCÓPICA DE CARRACA CON CORTE BATTIENTE

| ARTICOLO     | DESCRIZIONE                     | ART. AUSONIA |
|--------------|---------------------------------|--------------|
| <b>78081</b> | TRONCARAMI TELESCOPIC. cm 66-90 | 035081       |

**Ricambi**

|              |                      |        |
|--------------|----------------------|--------|
| <b>78082</b> | LAME PER ART. 78081  | 036081 |
| <b>78084</b> | MOLLA PER ART. 78081 | 036082 |

**FORBICE DA SIEPI A LAME LISCE E ONDULATE**

 TAILLE-HAIES A LAMES LISSES ET ONDULÉES  
 HEDGE SHEARS WITH SMOOTH AND CORRUGATED BLADES  
 HECKENSCHERE MIT GLATTER KLINGE UND MIT WELLENSCHLIFF  
 TIJERA PARA SETOS CON HOJAS LISAS Y ONDULADAS

| ARTICOLO     | DESCRIZIONE         | ART. AUSONIA |
|--------------|---------------------|--------------|
| <b>78061</b> | FORB SIEPI ONDULATE | 031205       |

**TRONCARAMI PROFESSIONALE**

 COUPE-BRANCHES PROFESSIONNEL  
 PROFESSIONAL LOPPER  
 PROFESSIONELLER ASTSCHNEIDER  
 CORTADORA DE RAMAS PROFESIONAL

| ARTICOLO     | DESCRIZIONE                   | ART. AUSONIA |
|--------------|-------------------------------|--------------|
| <b>78065</b> | TRONCARAMI PROF CM 85 T/RETTO | 035086       |
| <b>78066</b> | TRONCARAMI PROF CM 85 T/CURVO | 035092       |

**Ricambi**

|              |   |        |
|--------------|---|--------|
| <b>78067</b> | BULLONI RICAMBIO X 78065-78066              | 036236 |
| <b>78068</b> | LAMA RICAMBIO X ART. 78065                  | 036233 |
| <b>78069</b> | BATTENTE RICAMBIO X ART. 78065              | 036232 |
| <b>78070</b> | BULLONE ANCORAGGIO LEVA X 78065-78066       | 036237 |
| <b>78071</b> | BULLONE CON ANELLO SCORREVOLE X 78065-78066 | 036238 |
| <b>78072</b> | LAMA RICAMBIO X ART. 78066                  | 036235 |
| <b>78073</b> | BATTENTE RICAMBIO X ART. 78066              | 036234 |

**TRONCARAMI A FORBICE**

 COUPE-BRANCHE A CISEAUX  
 LOPPING SHEAR  
 ASTSCHERE  
 CORTADORA DE RAMAS DE TIJERA

| ARTICOLO     | DESCRIZIONE                 | ART. AUSONIA |
|--------------|-----------------------------|--------------|
| <b>78085</b> | TRONCARAMI TAGLIO BOX/DISPL | 035071       |

16

### TRONCARAMI A BATTENTE

COUPE-BRANCHE A CRÉMAILLÈRE  
ANVIL LOPPER  
AMBOSSASTSCHERE  
CORTADORA DE RAMAS DE BATIOENTE



| ARTICOLO     | DESCRIZIONE                 | ART. AUSONIA |
|--------------|-----------------------------|--------------|
| <b>78087</b> | TRONCARAMI BATTENTE BOX/DIS | 035074       |

#### Ricambi

|              |                             |        |
|--------------|-----------------------------|--------|
| <b>78088</b> | BULLONE RIC. PER ART. 78087 | 036295 |
| <b>78168</b> | LAMA                        | 036291 |
| <b>78169</b> | BATTENTE                    | 036292 |

### SVETTATOIO A PERTICA PROFESSIONALE CON TAGLIO A CRICCHETTO

SÉCATEUR-ÉLAGUEUR A PERCHE PROFESSIONNEL AVEC COUPE A CLIQUE  
PROFESSIONAL RATCHET CUT TREE PRUNER  
PROFESSIONELLE TELESKOPSÄGE MIT KNARRENMECHANISMUS  
DESMOCHADORA PROFESIONAL CON CORTE DE CARRARA



| ARTICOLO     | DESCRIZIONE                 | ART. AUSONIA |
|--------------|-----------------------------|--------------|
| <b>78093</b> | SVETT.CRICCHETTO MCO TLSCOP | 035053       |

#### Ricambi

|              |                          |        |
|--------------|--------------------------|--------|
| <b>78094</b> | MOLLA RIC PER ART. 78093 | 036247 |
| <b>78095</b> | LAMA RIC PER ART. 78093  | 036248 |
| <b>78096</b> | SEGA PER ART. 78093      | 036249 |

### FORBICE AD ASTA TELESCOPICA STANDARD

CISEAU A TIGE TÉLESCOPIQUE STANDARD  
STANDARD TELESCOPIC POLE PRUNER  
STANDARD-HOCHENTASTER  
TIJERA CON VARILLA TELESCOPICA STANDARD



| ARTICOLO     | DESCRIZIONE                 | ART. AUSONIA |
|--------------|-----------------------------|--------------|
| <b>78101</b> | CESOIE TELES.MT.1,8-3,0 STD | 035131       |

#### Ricambi

|              |                     |        |
|--------------|---------------------|--------|
| <b>78102</b> | LAMA PER ART.78101  | 036276 |
| <b>78103</b> | MOLLA PER ART.78101 | 036278 |

### SVETTATOIO A PERTICA DOPPIA CORDA

SÉCATEUR-ÉLAGUEUR A PERCHE  
PROFESSIONAL TREE PRUNER  
PROFESSIONELLE TELESKOPSÄGE  
DESMOCHADORA PROFESIONAL



| ARTICOLO     | DESCRIZIONE                | ART. AUSONIA |
|--------------|----------------------------|--------------|
| <b>78185</b> | SVETT.PERTICA DOPPIA CORDA | 035052       |

### MANICO TELESCOPICO UNIVERSALE

MANCHE TÉLESCOPIQUE UNIVERSEL  
UNIVERSAL TELESCOPIC HANDLE  
UNIVERSALTELESKOPSTIEL  
MANGO TELESCOPICO UNIVERSAL

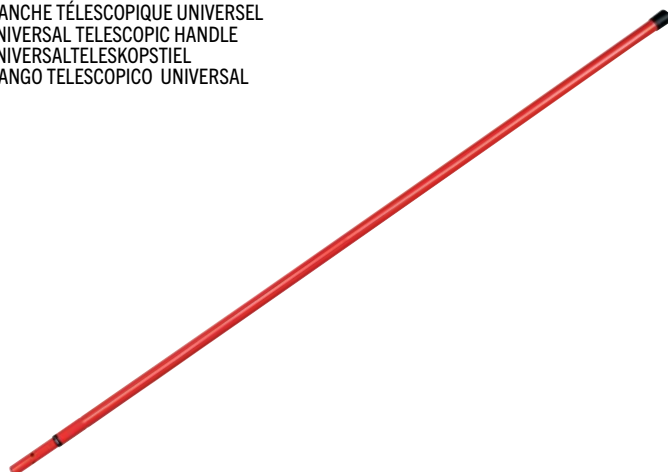

| ARTICOLO     | DESCRIZIONE             | ART. AUSONIA |
|--------------|-------------------------|--------------|
| <b>78097</b> | PERTICA TELESCOPICA m 3 | 036956       |

### SEGHETTO POTATURA CHIUDIBILE TURBO

SCIE TAILLE REPLIABLE TURBO  
FOLDING TURBO PRUNING SAW  
KLAPPGARTENSÄGE TURBO  
SIERRA DE PODA PLEGABLE TURBO



| ARTICOLO     | DESCRIZIONE                  | ART. AUSONIA |
|--------------|------------------------------|--------------|
| <b>78104</b> | SEGH.TURBO 180 mm.CHIUDIBILE | 034055       |
| <b>78105</b> | SEGH TURBO 210 mm.CHIUDIBILE | 034056       |
| <b>78106</b> | SEGH.TURBO 270 mm.CHIUDIBILE | 034058       |

#### Ricambi

|              |                       |        |
|--------------|-----------------------|--------|
| <b>78107</b> | LAMA X SEGH.POT.78105 | 034256 |
| <b>78108</b> | LAMA X SEGH.POT.78106 | 034258 |
| <b>78109</b> | LAMA X SEGH.POT.78104 | 034260 |





### SEGHETTO POTATURA TURBO CON FODERO

SCIE TAILLE TURBO AVEC ETUI  
TURBO PRUNING SAW WITH SHEATH  
TURBOGARTENSÄGE MIT ETUI  
SIERRA DE PODA TURBO CON FUNDA



| ARTICOLO     | DESCRIZIONE                  | ART. AUSONIA |
|--------------|------------------------------|--------------|
| <b>78110</b> | SEGH.TURBO 240 MCO ANTISCIV  | 034047       |
| <b>78111</b> | SEGH TURBO 300 MCO ANTISCIV  | 034048       |
| <b>78112</b> | SEGH.TURBO 270 MCO ANTISCIV. | 034051       |

#### Ricambi

|              |                               |        |
|--------------|-------------------------------|--------|
| <b>78113</b> | LAMA PER SEGH.POT. ART. 78110 | 034247 |
| <b>78114</b> | LAMA PER SEGH.POT. ART. 78111 | 034248 |
| <b>78115</b> | LAMA PER SEGH.POT. ART. 78112 | 034251 |

### RASTRELLO A VENTAGLIO

RÂTEAU A EVENTAIL  
FAN RAKE  
FÄCHERBESEN  
RASTRILLO EN ABANICO



**FIG. 1**

**FIG. 2**

| ARTICOLO     | DESCRIZIONE                                | ART. AUSONIA |
|--------------|--|--------------|
| <b>78174</b> | RASTRELLO A VENTAGLIO PLASTICA - FIG.1     | 035108       |
| <b>78120</b> | RASTRELLO A DENTI CURVI - 16 DENTI - FIG.2 | 080765       |

#### Ricambi

|              |  |        |
|--------------|--|--------|
| <b>78121</b> | MANICO LEGNO RASTRELLO cm 130 - FIG.2  | 088513 |
| <b>78176</b> | MANICO LEGNO RASTRELLO PLASTICA- FIG.1 | 048036 |

### MAZZASCURE CON MANICO

COGNÉE AVEC MANCHE  
SLEDGEHAMMER-AXE WITH WOODEN HANDLE  
SPALTHAMMER MIT STIEL  
HACHA CON MANGO



| ARTICOLO     | DESCRIZIONE            | ART. AUSONIA |
|--------------|------------------------|--------------|
| <b>78126</b> | MAZZASCURE kg 2,5 C.M. | 084517       |

#### Ricambi

|              |                                       |        |
|--------------|---------------------------------------|--------|
| <b>78127</b> | MANICO IN LEGNO PER MAZZASCURE mm 900 | 048040 |
|--------------|---------------------------------------|--------|

### UTENSILI PER GIARDINAGGIO

OUTILS POUR LE JARDINAGE  
GARDENING TOOLS  
WERKZEUGE FÜR DEN GARTENBAU  
HERRAMIENTAS PARA JARDINERÍA

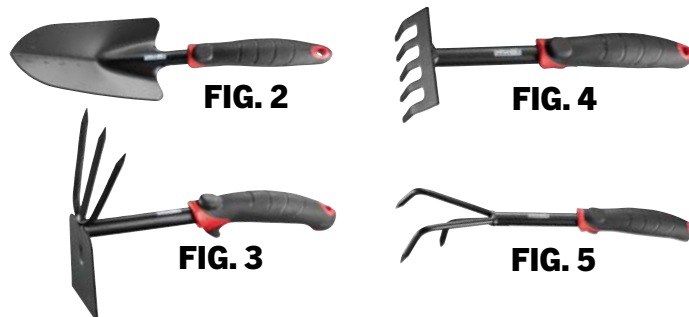

**FIG. 2**

**FIG. 4**

**FIG. 3**

**FIG. 5**

| ARTICOLO     | DESCRIZIONE             | ART. AUSONIA |
|--------------|-------------------------|--------------|
| <b>78171</b> | PALETTA LARGA (FIG.2)   | 035214       |
| <b>78172</b> | ZAPPETTA QUADRA (FIG.3) | 035215       |
| <b>78173</b> | RASTRELLINO (FIG.4)     | 035216       |
| <b>78175</b> | COLTIVATORE (FIG.5)     | 035211       |

### PICOZZINO DA CARPENTIERE - SCURE CON MANICO

PIC DE CHARPENTIER - HACHE AVEC MANCHE  
CARPENTER'S HATCHET - AXE WITH HANDLE  
SCHREINERBEIL - AXT MIT STIEL  
HACHA DE CARPINTERO - ON MANGO



**FIG. 1**

**FIG. 2**

| ARTICOLO     | DESCRIZIONE                    | ART. AUSONIA |
|--------------|--------------------------------|--------------|
| <b>78123</b> | PICCOZZINO g 500 FORG. - FIG.1 | 027103       |
| <b>78125</b> | SCURE MCO LEGNO g 1500 - FIG.2 | 086897       |

### MAZZASCURE CON MANICO

COGNÉE AVEC MANCHE  
SLEDGEHAMMER-AXE WITH HANDLE  
SPALTHAMMER MIT STIEL  
HACHA CON MANGO

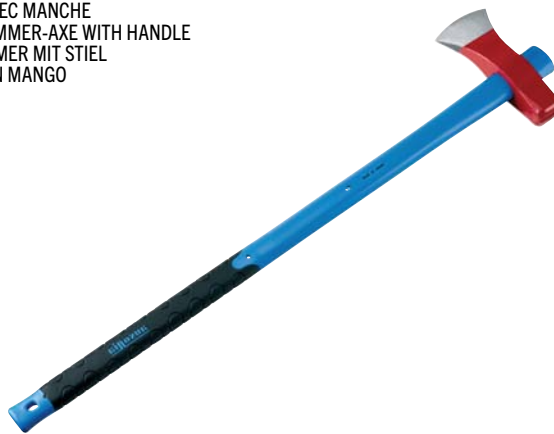

| ARTICOLO     | DESCRIZIONE                    | ART. AUSONIA |
|--------------|--------------------------------|--------------|
| <b>78128</b> | MAZZASCURE kg 2,5 MANICO FIBRA | 084519       |

#### Ricambi

|              |  |        |
|--------------|--|--------|
| <b>78129</b> | MANICO IN RESINA PER MAZZASCURE mm 900 | 048086 |
|--------------|--|--------|



16

### MACHETE CON FODERO

MACHETE AVEC ETUI  
MACHETE WITH SHEATH  
HAUMESSER MIT HÜLLE  
MACHETE CON FUNDA



| ARTICOLO | DESCRIZIONE                         | FIG. | ART. AUSONIA |
|----------|-------------------------------------|------|--------------|
| 78130    | MACHETE L.IX cm 46 C/FOD.NYLON      | 1    | 028403       |
| 78131    | MACHETE L.IX cm 36 C/FOD.NYLON      | 1    | 028404       |
| 78192    | MACHETE M.CORDA L.TEFL. cm 40 C/FOD | 2    | 028412       |
| 78190    | MACHETE MCO PL L.TEFL. cm 32 C/FOD  | 4    | 028413       |

### VANGHETTO A "T"

BÈCHE EN «T»  
DIGGING SPARE WITH "T" HANDLE  
SPATEN «T»-STIEL  
PALA EN "T"



| ARTICOLO | DESCRIZIONE                    | ART. AUSONIA |
|----------|--------------------------------|--------------|
| 78138    | VANGHETTO C/MANICO LEGNO A "T" | 084690       |

### RACCOGLI RIFIUTI

COLLECTEUR DE DÉCHETS  
WASTE-PICKER  
ABFALLSAMMLER  
COLECTOR DE BASURA



| ARTICOLO | DESCRIZIONE      | ART. AUSONIA |
|----------|------------------|--------------|
| 78186    | RACCOGLI RIFIUTI | 035253       |

### PALE - BADILI - VANGHE

PELLES - BÈCHES - PIOCHES  
SHOVELS - SPADES  
SPATEN - SCHAUFELN  
PALAS



| ARTICOLO | DESCRIZIONE                                  | ART. AUSONIA |
|----------|--|--------------|
| 78132    | PALA ALLUM. GR790 S.M. - FIG.4               | 084640       |
| 78133    | BADILE STD TEMPERATO S.M. - FIG.1            | 084650       |
| 78134    | BADILE MUSO BUE TEMP.STD S.M. - FIG.2        | 084653       |
| 78122    | BADILE A PUNTA QUADRA TEMPERATO S.M. - FIG.5 | 084663       |

#### Ricambi

|       |   |        |
|-------|---|--------|
| 78136 | MANICO LEGNO PER PALA-BADILE-VANGA 1400 mm  | 048047 |
| 78137 | MANICO RESINA PER PALA-BADILE-VANGA 1400 mm | 048051 |

### FORCA PER FIELO - ZAPPA FORGIATA BIDENTE - ZAPPA FORGIATA

FOURCHE A FOIN - PIOCHE FORGEE DEUX DENTS - PIOCHE FORGEE  
HAY FORK - TWO-PRONGED FORGED HOE - FORGED HOE  
HEUGABEL - ZWEIZAHNHACKE - HACKE  
HORCA PARA HENO - AZADA FORJADA DE DOS DIENTES - AZADA FORJADA

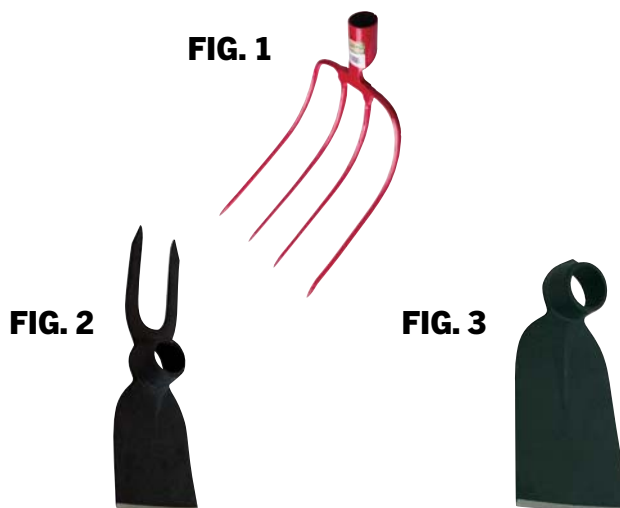

| ARTICOLO | DESCRIZIONE                             | ART. AUSONIA |
|----------|---|--------------|
| 78139    | FORCA FIELO 4 DENTI S.M. - FIG.1        | 080601       |
| 78140    | ZAPPA FORG. BIDENTE gr.600 S.M. - FIG.2 | 080309       |
| 78141    | ZAPPA FORGIATA gr.800 S.M. - FIG.3      | 080417       |

#### Ricambi

|       |                                |        |
|-------|--------------------------------|--------|
| 78142 | MCO ZAPPA OCCHIO TONDO mm 1200 | 048042 |
| 78143 | MCO LEGNO ZAPPINO BIDENTE      | 048043 |
| 78136 | MANICO LEGNO PER FORCA mm 1400 | 048047 |

### SEGONCINI PROFESSIONALI

SCIES PROFESSIONNELLES  
PROFESSIONAL BOW SAWS  
PROFESSIONELLE BÜGELSÄGEN  
SIERRAS PROFESIONALES

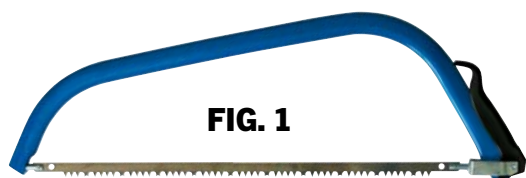

FIG. 1



FIG. 2



FIG. 3



FIG. 4

| ARTICOLO     | DESCRIZIONE                         | ART. AUSONIA |
|--------------|-------------------------------------|--------------|
| <b>78144</b> | SEGHETTO 533 mm GIREV.PROF. - FIG.1 | 034013       |
| <b>78146</b> | SEGHETTO 610 mm FISSO - FIG.2       | 034014       |
| <b>78145</b> | SEGHETTO 762 mm FISSO - FIG.2       | 034015       |

#### Ricambi

|              |                                |        |
|--------------|--------------------------------|--------|
| <b>78147</b> | LAMA DENTE CAST 533 mm - FIG.3 | 083273 |
| <b>78148</b> | LAMA DENTE V 533 mm - FIG.4    | 083285 |
| <b>78159</b> | LAMA DENTE V 610 mm - FIG.4    | 083289 |
| <b>78160</b> | LAMA DENTE CAST 610 mm - FIG.3 | 083277 |
| <b>78149</b> | LAMA DENTE CAST 762 mm - FIG.3 | 083281 |

### COLTELLI DA INNESTO

COUTEAUX A BOUTURER  
GRAFTING KNIVES  
PFROPFMESSER  
CUCHILLOS PARA INJERTA



| ARTICOLO     | DESCRIZIONE               | ART. AUSONIA |
|--------------|---------------------------|--------------|
| <b>78153</b> | COLT INNESTO MCO F C INOX | 032005       |

### RONCOLE - FALCIOLE

SERPES - FAUX  
GARDENING KNIVES - SICKLES  
GARTENMESSER - SICHELN  
NAVAJAS - PODADERAS



FIG. 1



FIG. 2



FIG. 3



FIG. 4



FIG. 5

| ARTICOLO     | DESCRIZIONE                           | ART. AUSONIA |
|--------------|---------------------------------------|--------------|
| <b>78151</b> | RONCOLA MCO PLASTICA cm 14 - FIG.1    | 033010       |
| <b>78152</b> | RONCOLA MCO PLASTICA cm 18 - FIG.1    | 033020       |
| <b>78155</b> | RONCOLA FORG.MCO CUOIO cm 27 - FIG.2  | 033243       |
| <b>78157</b> | RONCOLA MCO FERRO TUBO cm 30 - FIG.3  | 033234       |
| <b>78156</b> | FALCIOLA LISCIA MCO LEGNO '1' - FIG.4 | 033264       |
| <b>78158</b> | FALCIOLA PERTICA M/FERRO TUBO - FIG.5 | 033282       |

### COLTELLI

COUTEAUX  
KNIVES  
MESSER  
CUCHILLOS



FIG. 1



FIG. 3



FIG. 4



FIG. 5



FIG. 7

| ARTICOLO     | DESCRIZIONE                                 | ART. AUSONIA |
|--------------|---|--------------|
| <b>78008</b> | COLTELLO TIPO SARDO cm 16 - FIG.1           | 23158        |
| <b>78010</b> | COLTELLO DA TASCA cm 20 - FIG.3             | 26238        |
| <b>78150</b> | COLTELLO SICUREZZA - FIG.4                  | 26444        |
| <b>78188</b> | COLT TASCA cm 20,5 L IX MCO PLASTIC - FIG.5 | 026338       |
| <b>78193</b> | COGLIFUNGHY MANICO BICOLORE cm 18 - FIG.7   | 026306       |

### MATERIALE PER LA LEGATURA

MATERIEL POUR LA LIGATURE - BINDING MATERIAL - MATERIAL ZUM BINDEN - MATERIAL DE ATADURA

#### TUBETTO PER LEGATURE IN PVC

LIEN TUBE CREUX POUR LIGATURES EN PVC  
PVC BINDING TUBE  
PVC-SCHLAUCH ZUM BINDEN  
TUBO PARA ATADURA EN PVC

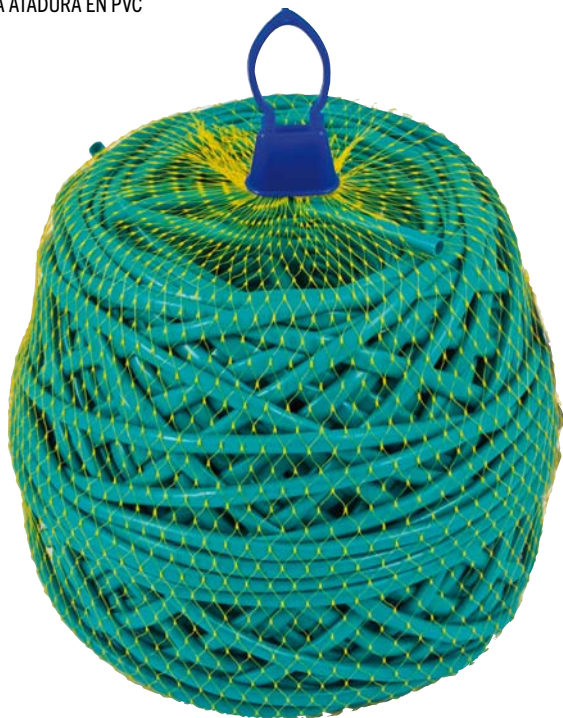

#### CARATTERISTICHE

Gomitolo da 1kg in PVC antigelo tipo ecologico 1ª scelta esente da metalli pesanti.

| ARTICOLO     | DESCRIZIONE           | LUNGHEZZA<br>m | PESO<br>kg |
|--------------|-----------------------|----------------|------------|
| <b>78161</b> | Tubetto in PVC Ø 2 mm | 225            | 1,00       |
| <b>78162</b> | Tubetto in PVC Ø 3 mm | 148            |            |
| <b>78163</b> | Tubetto in PVC Ø 4 mm | 113            |            |
| <b>78164</b> | Tubetto in PVC Ø 5 mm | 85             |            |

#### ROCCHELLA DI PIATTINA ANIMATA IN PVC DA 600 GR - 250 m

BOBINE DE RUBAN A AME PVC DE 600 G - 250 m  
SPOOL OF STRAP WITH PVC CORE 600 G - 250 m  
SPULE MIT PVC-VERSTÄRKTER FLACHSCHNUR VON 600 G - 250 m  
COPO DE CABLE/CINTA CON ÁNIMA EN PVC DE 600 GR - 250 m



ARTICOLO  
**78165**

#### ROCCHELLA DI PIATTINA ANIMATA IN PVC DA 200 g - 80 m

OUTILS POUR LE JARDINAGE  
GARDENING TOOLS  
WERKZEUGE FÜR DEN GARTENBAU  
HERRAMIENTAS PARA JARDINERIA



ARTICOLO  
**78166**

### SEGHE TTA A BATTERIA 20V

PETITE SCIE À MÉTAUX SUR BATTERIE 20V  
20V CORDLESS HACKSAW  
AKKU-STICHSÄGE 20 V  
SIERRA DE BATERÍA 20 V



new

#### CARATTERISTICHE

- Copertura di protezione catena
- Manopola di regolazione tensione della catena senza l'utilizzo di attrezzi
- Blocco di sicurezza
- Impugnatura antiscivolo
- Ricarica rapida (1h)
- Estremamente leggero

#### FEATURES

- Protection Cover
- Tool free tension knob
- Safety Lock
- Anti Skid Handle
- 1H fast Charger
- Super Light

| CATENA DI RICAMBIO |  |
|--------------------|--|
| <b>78224</b>       |  |

| ARTICOLO     | VOLT | BATTERIA Li-ion (OPTIONAL)               | RICARICA h | BARRA cm | CATENA |
|--------------|------|--|------------|----------|--------|
| <b>78194</b> | 20   | <b>78198</b> (2Ah)<br><b>78199</b> (4Ah) | 1          | 10       | 1/4"   |

**NB: la batteria ed il carica batterie sono da ordinare a parte.**

### SEGHE TTA A BATTERIA 20V CON CIRCUITO DI LUBRIFICAZIONE

PETITE SCIE À MÉTAUX SUR BATTERIE 20V AVEC CIRCUIT DE LUBRIFICATION  
20V CORDLESS HACKSAW WITH LUBRICATION CIRCUIT  
AKKU-STICHSÄGE 20 V MIT SCHMIERKREISLAUF  
SIERRA DE BATERÍA 20 V CON CIRCUITO DE LUBRIFICACIÓN



new

#### CARATTERISTICHE

- Finestra trasparente livello olio
- Copertura di protezione catena
- Manopola di regolazione tensione della catena senza l'utilizzo di attrezzi
- Blocco di sicurezza
- Impugnatura antiscivolo
- Ricarica rapida (1h)
- Estremamente leggero
- Lubrificazione automatica

#### FEATURES

- Transparent Window
- Protection Cover
- Tool free tension knob
- Safety Lock
- Anti Skid Handle
- 1H fast Charger
- Super Light
- Automatic lubrication

| CATENA DI RICAMBIO |  |
|--------------------|--|
| <b>78225</b>       |  |

| ARTICOLO     | VOLT | BATTERIA Li-ion (OPTIONAL)               | RICARICA h | BARRA cm | CATENA |
|--------------|------|--|------------|----------|--------|
| <b>78195</b> | 20   | <b>78198</b> (2Ah)<br><b>78199</b> (4Ah) | 1          | 15       | 1/4"   |

**NB: la batteria ed il carica batterie sono da ordinare a parte.**

### SOFFIATORE JET A BATTERIA 20V

SOUFFLEUR JET SUR BATTERIE 20V  
20V CORDLESS JET BLOWER  
AKKU-BLÄSER JET 20 V  
SOPLADOR JET DE BATERÍA 20 V



new

#### CARATTERISTICHE

- Riduzione delle vibrazioni durante il funzionamento
- Pulsante di sicurezza
- Indicatore LED
- Velocità variabile
- Ventola in stile turbina a getto per un volume d'aria elevato
- Ricarica rapida (1h)
- Estremamente leggero
- Basso rumore

#### FEATURES

- Handle Delivers Vibration Reduction In Operation
- Safety Push Button
- LED indicator
- Variable Speed
- Jet Turbine Style Fan Delivers High Air Volume
- 1H fast Charger
- Super Light
- Low Noise

| ARTICOLO     | VOLT | BATTERIA LI-ION (OPTIONAL)               | RICARICA h | VELOCITÀ DELL'ARIA km/h | VOLUME ARIA m³/min |
|--------------|------|--|------------|-------------------------|--------------------|
| <b>78196</b> | 20   | <b>78198</b> (2Ah)<br><b>78199</b> (4Ah) | 1          | 36 ÷ 151                | 1,9 ÷ 7,8          |

**NB: la batteria ed il carica batterie sono da ordinare a parte.**

16

### FORBICE A BATTERIA 20V TAGLIO 30 MM

CISEAUX SUR BATTERIE 20V COUPE 30 MM  
20V CORDLESS SCISSOR CUT 30 MM  
AKKU-SCHERE 20 V SCHNITT 30 MM  
TIJERA DE BATERIA 20 V CORTE 30 MM

new



#### CARATTERISTICHE

- Taglio progressivo (max. 30mm)
- Lama in acciaio
- Interruttore di alimentazione
- Interruttore a grilletto
- Indicatore LED di carica
- Ricarica rapida (1h)

#### FEATURES

- Progressive cutting (max. 30mm)
- Alloy Steel Blade
- Power Switch
- Trigger Switch
- Led Charge Indicator
- 1H fast Charger

**NB: la batteria ed il carica batterie sono da ordinare a parte.**

### BATTERIE 20V

BATTERIES 20V  
20V BATTERIES  
AKKUS 20 V  
BATERIAS 20 V

new



78198



78199

| ARTICOLO | DESCRIZIONE      |
|----------|------------------|
| 78198    | Batteria 20V 2Ah |
| 78199    | Batteria 20V 4Ah |

| ARTICOLO | VOLT | BATTERIA Li-ion (OPTIONAL) | RICARICA h | MOTORE ELETTRICO | PESO g |
|----------|------|----------------------------|------------|------------------|--------|
| 78197    | 20   | 78198 (2Ah)<br>78199 (4Ah) | 1          | BRUSHLESS 500W   | 1000   |

### CARICA BATTERIA

CHARGEUR DE BATTERIE  
BATTERY CHARGER  
AKKULADEGERÄT  
CARGADOR DE BATERIAS



| ARTICOLO |
|----------|
| 78200    |

### FORBICE A BATTERIA TAGLIO 35 MM

CISEAUX SUR BATTERIE COUPE 35 MM  
CORDLESS SCISSOR CUT 35 MM  
AKKU-SCHERE SCHNITT 35 MM  
TIJERA DE BATERIA CORTE 35 MM

new



#### CARATTERISTICHE

- Taglio progressivo (max. 35mm)
- Sistema di sicurezza
- 2 Batterie da 4,5Ah
- 1 Carica Batterie 16,8V - 2,0Ah

#### FEATURES

- Progressive cutting (max. 35mm)
- Safety System
- 2pcs 4.5Ah battery
- 1pc 16.8V 2.0Ah Charger

| RICAMBI |            |
|---------|------------|
| LAMA    | CONTROLAMA |
| 78222   | 78223      |

| ARTICOLO | VOLT | BATTERIA Li-ion | TEMPO DI UTILIZZO h | RICARICA h |
|----------|------|-----------------|---------------------|------------|
| 78201    | 16,8 | 4,5Ah           | 2-4                 | 3-4        |

### POTATORE ELETTRICO A BATTERIE

ÉLAGUEUSE ÉLECTRIQUE SUR BATTERIE  
ELECTRIC BATTERY PRUNER  
AKKU-ELEKTROSCHERE  
PODADOR ELÉCTRICO DE BATERÍAS

new



Il potatore a batteria Minelli EnerQ1 per la potatura è caratterizzato per la precisione di taglio ed efficacia ed è un attrezzo indispensabile per chi ha necessità di portare con sé un alleato maneggevole e compatto, ideale per il taglio di arbusti, rami o cespugli.

Utile per facilitare le operazioni in frutteto, uliveto e vigneto o semplicemente per eseguire finiture impeccabili con estrema rapidità, Ener-Q1 è l'attrezzo ideale per chiunque voglia dedicarsi al verde per passione, senza rinunciare alla potenza, alla funzionalità e agli standard qualitativi tipici del brand Minelli. Minelli Ener-Q1 può tagliare rami e arbusti fino a una dimensione massima di 5 cm di diametro, offrendo performances sicure e un'ottima operatività in ogni contesto. La catena da 1/4" è montata su una barra da 4".

Ad azionare il potatore cordless è un motore Brushless controllato da una scheda elettronica e la massima potenza raggiunta dall'utensile a batteria è di 252 W.

L'impugnatura ergonomica antiscivolo e il peso di 1,40 kg (compreso di batteria) rendono il Minelli estremamente confortevole e semplice da utilizzare.

#### CARATTERISTICHE

Batteria Li-ion 16,8V 2.0Ah  
Tempo di ricarica 1,5 h  
Motore elettrico Brushless  
Barra 4"  
Catena 11.1mm 1/4" - 0.043"  
Lubrificazione manuale  
Peso (senza batteria) 1,15 kg

#### Compreso nella confezione:

1 Potatore Cordless Ener-Q1  
2 Batterie Li-ion 16,8V 2.0Ah  
1 Caricabatterie  
1 Chiave  
1 Manuale d'uso  
1 Certificato di garanzia

**ATTENZIONE:** Il potatore lavora senza lubrificazione, ideale per colture biologiche.

**NON UTILIZZARE IN CONTINUITÀ**

| ARTICOLO     | VOLT | BATTERIA<br>Ah | RICARICA<br>h | MOTORE<br>ELETTRICO | BATTERIA | BARRA | CATENA                | PESO<br>kg |
|--------------|------|----------------|---------------|---------------------|----------|-------|-----------------------|------------|
| <b>21037</b> | 16,8 | 2,0            | 1,5           | BRUSCHLESS          | Li-ion   | 4"    | 11,1 mm 1/4" - 0,043" | 1,15       |



16

### FORBICE FRUTTA

CISAILLE A FRUITS  
ORCHARD SHEARS  
OBSTSCHERE  
TIJERA FRUTA



20718



21039

#### ADATTATORE PER ASTA



ARTICOLO  
20720

MADE IN ITALY

#### RICAMBI



Rivetto  
20945  
Lama mobile  
20946

| ARTICOLO | Ø TAGLIO mm | CONSUMO ARIA l/min | PRESSIONE MAX DI LAVORO (bar) | peso kg |
|----------|-------------|--------------------|-------------------------------|---------|
| 20718    | 35          | 80                 | 8                             | 0,65    |
| 21039    | 35          | 80                 | 10                            | 0,65    |

### FORBICE FRUTTA-VIGNETO - LITTLE SHEAR

CISAILLE FRUITS-VIGNOBLE - LITTLE SHEAR  
ORCHARD-VINEYARD - LITTLE SHEAR  
LEICHTE OBST-/WEINSCHERE  
TIJERA FRUTA-VIÑA - LITTLE SHEAR



20719

#### ADATTATORE PER ASTA



ARTICOLO  
20934

MADE IN ITALY

#### RICAMBI



Rivetto  
20947  
Lama mobile  
20948

| ARTICOLO | Ø TAGLIO mm | CONSUMO ARIA l/min | PRESSIONE MAX DI LAVORO (bar) | peso kg |
|----------|-------------|--------------------|-------------------------------|---------|
| 20719    | 28          | 80                 | 8                             | 0,46    |

### ASTE DI PROLUNGA FISSE

TIGES DE RALLONGE FIXES  
FIXED EXTENSION ROD  
FESTE VERLÄNGERUNGSSTANGEN  
BARRAS DE PROLONGACIÓN FIJAS

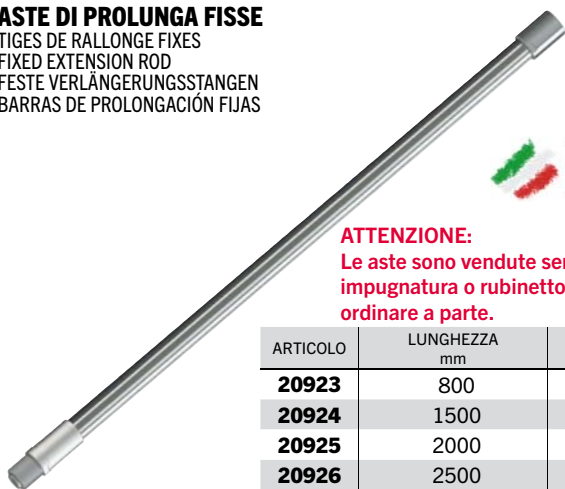

MADE IN ITALY

**ATTENZIONE:**  
Le aste sono vendute senza impugnatura o rubinetto che sono da ordinare a parte.

| ARTICOLO | LUNGHEZZA mm | peso kg |
|----------|--------------|---------|
| 20923    | 800          | 0,37    |
| 20924    | 1500         | 0,60    |
| 20925    | 2000         | 0,70    |
| 20926    | 2500         | 0,80    |
| 20927    | 3000         | 0,90    |

### ASTE DI PROLUNGA TELESCOPICHE

TIGES DE RALLONGE TELESCOPIQUES  
TELESCOPIC EXTENSION ROD  
AUSZIEHBARE VERLÄNGERUNGSSTANGEN  
BARRAS DE PROLONGACIÓN TELESCÓPICAS

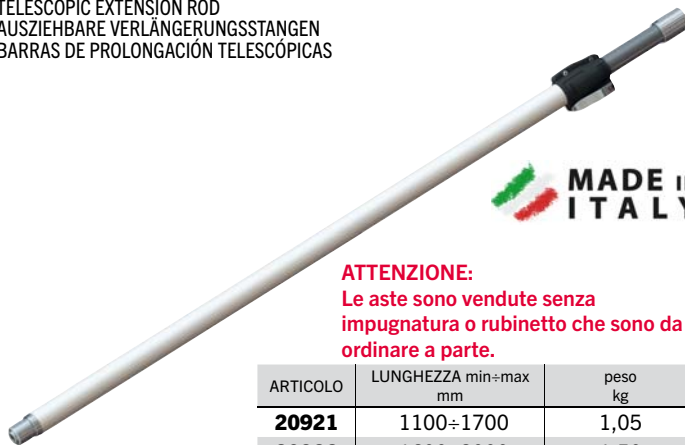

MADE IN ITALY

**ATTENZIONE:**  
Le aste sono vendute senza impugnatura o rubinetto che sono da ordinare a parte.

| ARTICOLO | LUNGHEZZA min-max mm | peso kg |
|----------|----------------------|---------|
| 20921    | 1100÷1700            | 1,05    |
| 20922    | 1600÷3000            | 1,50    |

### IMPUGNATURA

MANCHE  
HANDLE  
HANDGRIFFE  
EMPUÑADURAS



MADE IN ITALY

| ARTICOLO | peso kg |
|----------|---------|
| 20928    | 0,20    |

### RUBINETTO DIRETTO A LEVA

ROBINET A LEVIER  
LEVER COCK  
HEBELHAHN  
TAP PALANCA DIRECTO



MADE IN ITALY

| ARTICOLO | peso kg |
|----------|---------|
| 20929    | 0,12    |



### COMPRESSORI A 3 PUNTI

COMPRESSEURS A 3 POINTS  
3-POINT COMPRESSORS  
3 PUNKTKOMPRESSOREN  
COMPRESORES DE TRES PUNTOS



20733 - 20734



20874 - 20845

MADE IN ITALY

### AVVOLGITUBO MANUALE OPTIONAL (SENZA TUBO)



ARTICOLO  
20844

### OLIO LUBRIFICANTE 1L



ARTICOLO  
20803

| ARTICOLO | PORTATA<br>l/min | CAPACITÀ<br>l | PRESS.<br>bar | FORBICI<br>nr. | SEGHETTI<br>n | ABBACCH.<br>n | PESO<br>kg | DIMENSIONI<br>cm |
|----------|------------------|---------------|---------------|----------------|---------------|---------------|------------|------------------|
| 20733    | 550              | 24            | 11            | 5              | 1             | 2             | 105        | 72x61x90         |
| 20734    | 800              | 24            | 11            | 8              | 2             | 4             | 130        | 72x61x90         |
| 20874    | 1600             | 3x24          | 11            | 8/12           | 2             | 5             | 145        | 123x72x90        |
| 20845    | 2000             | 3x24          | 11            | 10/15          | 2/3           | 6             | 160        | 123x72x90        |

### MOTOCOMPRESSORE CARRELLATO BENZINA OLIVCER 65

COMPRESSEUR A ESSENCE AVEC CHARIOT OLIVCER 65  
COMPRESSOR GASOLINE ON WHEEL OLIVCER 65  
BENZINWAGENKOMPRESSOR MOD. OLIVCER 65  
GASOLINA COMPRESORA DE RUEDA OLIVCER 65



MADE IN ITALY

#### CARATTERISTICHE

Dotato di serbatoio tandem con capacità 11+11 l, motore HONDA GX 200 e pompa ABAC B4900. E' equipaggiato con gruppo "FR + L" METAL WORK, presa aria pulita, valvola di sicurezza, valvola di ritegno ed acceleratore automatico.

#### FEATURES

It is fitted with a 11+11 l capacity tank, HONDA GX 200 motor and ABAC B4900 pump. It comes equipped with a "FR + L" METAL WORK unit, clean air intake, safety valve, check valve and automatic accelerator.

### AVVOLGITUBO MANUALE OPTIONAL (SENZA TUBO)



ARTICOLO  
20844

### SUPPORTO PER AVVOLGITUBO



ARTICOLO  
20933

### OLIO LUBRIFICANTE 1L



ARTICOLO  
20803

| ARTICOLO | MOTORE          | PORTATA<br>l/min | CAPACITÀ<br>l | FORBICI<br>n | ABBACCH.<br>n | SEGHETTI<br>n | PESO<br>kg | DIMENSIONI<br>cm |
|----------|-----------------|------------------|---------------|--------------|---------------|---------------|------------|------------------|
| 20932    | HONDA<br>GX 200 | 530              | 11+11         | 5/6          | 3/4           | 1             | 68         | 75x75x85         |

### 16 MOTOCOMPRESSORE CARRELLATO BENZINA OLIVCER 35

COMPRESSEUR A ESSENCE AVEC CHARIOT OLIVCER 35  
 COMPRESSOR GASOLINE ON WHEEL OLIVCER 35  
 BENZINWAGENKOMPRESSOR MOD. OLIVCER 35  
 GASOLINA COMPRESORA DE RUEDA OLIVCER 35



**MADE IN ITALY**

#### CARATTERISTICHE

Dotato di serbatoio con capacità 24 l, motore HONDA GP 160 e pompa ABAC PAT24B. E' equipaggiato con gruppo "FR + L" METAL WORK, presa aria pulita, valvola di sicurezza, valvola di ritegno ed acceleratore automatico.

#### FEATURES

It is fitted with a 24 l capacity tank, HONDA GP160 motor and ABAC PAT24 pump. It comes equipped with a "FR + L" METAL WORK unit, clean air intake, safety valve, check valve and automatic accelerator.

#### AVVOLGITUBO MANUALE OPTIONAL (SENZA TUBO)



ARTICOLO  
**20844**

#### SUPPORTO PER AVVOLGITUBO



ARTICOLO  
**20933**

#### OLIO LUBRIFICANTE 1L



ARTICOLO  
**20803**

| ARTICOLO     | MOTORE          | PORTATA<br>l/min | CAPACITÀ<br>l | FORBICI<br>n | ABBACCH.<br>n | SEGHETTI<br>n | PESO<br>kg | DIMENSIONI<br>cm |
|--------------|-----------------|------------------|---------------|--------------|---------------|---------------|------------|------------------|
| <b>20930</b> | HONDA<br>GP 160 | 330              | 24            | 2/3          | 1/2           | -             | 45         | 75x40x70         |

### KIT MOTOCOMPRESSORE CARRELLATO BENZINA OLIVCER 35 PER 1 OPERATORE

KIT COMPRESSEUR A ESSENCE AVEC CHARIOT OLIVCER 35 POUR 1 OPERATEUR  
 COMPRESSOR GASOLINE ON WHEEL OLIVCER 35 KIT FOR 1 OPERATOR  
 KIT BENZINWAGENKOMPRESSOR MOD. OLIVCER 35 FÜR 1 BEDIENER  
 KIT GASOLINA COMPRESORA DE RUEDA OLIVCER 35 PARA 1 OPERADOR

**new**

**MADE IN ITALY**



+



#### KIT composto da:

- Nr. 1 motocompressore Art. 20930.
- Nr. 1 abbacchiatore pneumatico Art. 20920.
- Nr. 1 prolunga telescopica 1100 - 1700 mm Art. 20921.
- Nr. 1 impugnatura Art. 20928.
- Nr. 1 tubo di collegamento raccordato 20 m.

#### ACCESSORI A COMPLEMENTO

|   |   |   |
|---|---|---|
|  |  |  |
| AVVOLGITUBO MANUALE (senza tubo)  | SUPPORTO PER AVVOLGITUBO  | OLIO LUBRIFICANTE 1L  |
| ARTICOLO<br><b>20844</b>  | ARTICOLO<br><b>20933</b>  | ARTICOLO<br><b>20803</b>  |

ARTICOLO  
**20737**

### MOTOCOMPRESSORE CARRELLATO BENZINA OLIVCER 55

COMPRESSEUR A ESSENCE AVEC CHARIOT OLIVCER 55  
 COMPRESSOR GASOLINE ON WHEEL OLIVCER 55  
 BENZINWAGENKOMPRESSOR MOD. OLIVCER 55  
 GASOLINA COMPRESORA DE RUEDA OLIVCER 55



#### CARATTERISTICHE

Dotato di serbatoio tandem con capacità 11+11 l, motore HONDA GP 160 e pompa ABAC PAT38B. E' equipaggiato con gruppo "FR + L" METAL WORK, presa aria pulita, valvola di sicurezza, valvola di ritegno ed acceleratore automatico.

#### FEATURES

It is fitted with a 11+11 l capacity tank, HONDA motor and ABAC PAT38B pump. It comes equipped with a "FR + L" METAL WORK unit, clean air intake, safety valve, check valve and automatic accelerator.

#### AVVOLGITUBO MANUALE OPTIONAL (SENZA TUBO)

ARTICOLO  
**20844**



#### SUPPORTO PER AVVOLGITUBO

ARTICOLO  
**20933**



#### OLIO LUBRIFICANTE 1L

ARTICOLO  
**20803**



| ARTICOLO     | MOTORE          | PORTATA<br>l/min | CAPACITÀ<br>l | FORBICI<br>n | ABBACCH.<br>n | SEGHETTI<br>n | PESO<br>kg | DIMENSIONI<br>cm |
|--------------|-----------------|------------------|---------------|--------------|---------------|---------------|------------|------------------|
| <b>20931</b> | HONDA<br>GP 160 | 490              | 11+11         | 4/5          | 2/3           | 1             | 65         | 75x65x65         |

### KIT MOTOCOMPRESSORE CARRELLATO BENZINA OLIVCER 55 PER 2 OPERATORE

KIT COMPRESSEUR A ESSENCE AVEC CHARIOT OLIVCER 55 POUR 2 OPERATEUR  
 COMPRESSOR GASOLINE ON WHEEL OLIVCER 55 KIT FOR 2 OPERATOR  
 KIT BENZINWAGENKOMPRESSOR MOD. OLIVCER 55 FÜR 2 BEDIENER  
 KIT GASOLINA COMPRESORA DE RUEDA OLIVCER 55 PARA 2 OPERADOR

new

MADE IN  
 ITALY



+



#### ACCESSORI A COMPLETAMENTO

|   |   |   |
|---|---|---|
|  |  |  |
| AVVOLGITUBO MANUALE (senza tubo)  | SUPPORTO PER AVVOLGITUBO  | OLIO LUBRIFICANTE 1L  |
| ARTICOLO<br><b>20844</b>  | ARTICOLO<br><b>20933</b>  | ARTICOLO<br><b>20803</b>  |

ARTICOLO  
**20738**

### ACCESSORI PER MOTOCOMPRESSORI

ACCESSOIRES POUR COMPRESSEUR A ESSENCE - COMPRESSOR GASOLINE ACCESSORIES - ZUBEHOER FÜR BENZINWAGENKOMPRESSOR - ACCESSORIOS PARA GASOLINA COMPRESORA



#### FILTRO REGOLATORE DI PRESSIONE ARIA

FILTRE RÉGULATEUR DE PRESSION D'AIR  
AIR PRESSURE REGULATOR FILTER  
LUFTDRUCKREGLERFILTER  
FILTRO REGULADOR DE PRESION DE AIRE

new



#### RICAMBI

|   |   |
|---|---|
|  |  |
| Tazza per filtro 1/4"<br>21001  | Tazza per filtro 3/8"<br>21002  |
| <b>21019</b>  | <b>21021</b>  |

| ARTICOLO     | DESCRIZIONE                              |
|--------------|--|
| <b>21001</b> | Filtro regolatore di pressione aria 1/4" |
| <b>21002</b> | Filtro regolatore di pressione aria 3/8" |

#### LUBRIFICATORE ARIA

LUBRIFICATEUR D'AIR  
AIR LUBRICATOR  
LUFTSCHMIERMITTEL  
LUBRICADOR DE AIRE

new



#### RICAMBI

|  |  |
|--|--|
|  |  |
| Tazza per filtro 1/4"<br>21003   | Tazza per filtro 3/8"<br>21004   |
| <b>21020</b>   | <b>21022</b>   |

| ARTICOLO     | DESCRIZIONE             |
|--------------|-------------------------|
| <b>21003</b> | Lubrificatore aria 1/4" |
| <b>21004</b> | Lubrificatore aria 3/8" |

#### FILTRO ARIA

FILTRE À AIR  
AIR FILTER  
LUFTFILTER  
FILTRO AIRE

new



#### RICAMBI

|   |   |
|---|---|
|  |  |
| Tazza per filtro 1/4"<br>21005  | Tazza per filtro 3/8"<br>21006  |
| <b>21019</b>  | <b>21021</b>  |

| ARTICOLO     | DESCRIZIONE      |
|--------------|------------------|
| <b>21005</b> | Filtro aria 1/4" |
| <b>21006</b> | Filtro aria 3/8" |

#### VALVOLA DI RITEGNO CON PILOTAGGIO

CLAPET ANTI-RETOUR AVEC PILOTAGE  
CHECK VALVE WITH PILOTING  
VENTIL MIT PILOTIERUNG PRÜFEN  
VÁLVULA DE CONTROL CON PILOTO

new



21007



21008  
21009

| ARTICOLO     | DESCRIZIONE                            |
|--------------|--|
| <b>21007</b> | Valvola di ritegno con pilotaggio 3/8" |
| <b>21008</b> | Valvola di ritegno con pilotaggio 1/2" |
| <b>21009</b> | Valvola di ritegno con pilotaggio 3/4" |

### ABBACCHIATORI PNEUMATICI

VIBREURS PNEUMATIQUES - PNEUMATIC OLIVE HARVESTERS - PNEUMATISCHE BAUMRÜTTLER - SACUDIDORES NEUMÁTICOS



**MADE IN ITALY**

#### RICAMBI



Kit rastrello

**20943**



Kit guarnizioni

**20944**

| ARTICOLO     | PORTATA ARIA l/min | PRESSIONE bar | battiti/min | PESO kg |
|--------------|--------------------|---------------|-------------|---------|
| <b>20920</b> | 200                | 7             | 1700        | 0,9     |

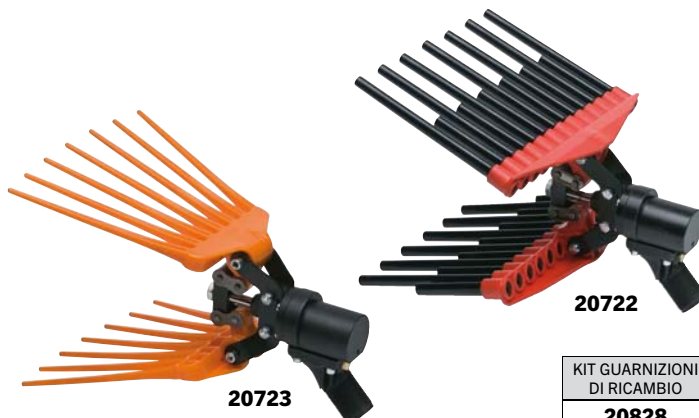

**20723**

**20722**

KIT GUARNIZIONI DI RICAMBIO  
**20828**

| ARTICOLO     | PORTATA ARIA l/min | PRESSIONE bar | battiti/min | PESO kg |
|--------------|--------------------|---------------|-------------|---------|
| <b>20722</b> | 200                | 6/8           | 1650        | 1,0     |
| <b>20723</b> | 200                | 6/8           | 1650        | 1,0     |

### OLIVCER AIR 505

new

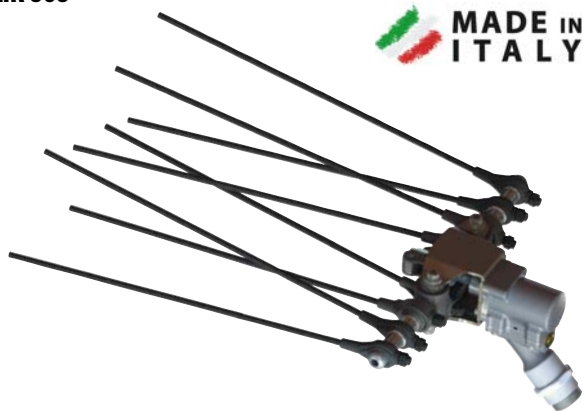

**MADE IN ITALY**

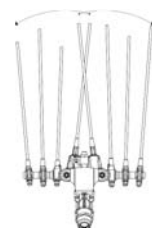

| ARTICOLO     | PORTATA ARIA l/min | PRESSIONE bar | battiti/min | PESO kg |
|--------------|--------------------|---------------|-------------|---------|
| <b>20997</b> | 200                | 7             | 1800        | 0,9     |

### ASTE DI PROLUNGA FISSE

TIGES DE RALLONGE FIXES  
FIXED EXTENSION ROD  
FESTE VERLÄNGERUNGSSTANGEN  
BARRAS DE PROLONGACIÓN FIJAS



**MADE IN ITALY**

**ATTENZIONE:**  
Le aste sono vendute senza impugnatura o rubinetto che sono da ordinare a parte.

| ARTICOLO     | LUNGHEZZA mm | peso kg |
|--------------|--------------|---------|
| <b>20923</b> | 1000         | 0,37    |
| <b>20924</b> | 1500         | 0,60    |
| <b>20925</b> | 2000         | 0,70    |
| <b>20926</b> | 2500         | 0,80    |
| <b>20927</b> | 3000         | 0,90    |

### ASTE DI PROLUNGA TELESCOPICHE

TIGES DE RALLONGE TELESCOPIQUES  
TELESCOPIC EXTENSION ROD  
AUSZIEHBARE VERLÄNGERUNGSSTANGEN  
BARRAS DE PROLONGACIÓN TELESCÓPICAS



**MADE IN ITALY**

**ATTENZIONE:**  
Le aste sono vendute senza impugnatura o rubinetto che sono da ordinare a parte.

| ARTICOLO     | LUNGHEZZA min÷max mm | peso kg |
|--------------|----------------------|---------|
| <b>20921</b> | 1100÷1700            | 1,05    |
| <b>20922</b> | 1600÷3000            | 1,50    |

### IMPUGNATURA

MANCHE  
HANDLE  
HANDGRIFFE  
EMPUÑADURAS



**MADE IN ITALY**

| ARTICOLO     | peso kg |
|--------------|---------|
| <b>20928</b> | 0,20    |

### RUBINETTO DIRETTO A LEVA

ROBINET A LEVIER  
LEVER COCK  
HEBELHAHN  
TAP PALANCA DIRECTO



**MADE IN ITALY**

| ARTICOLO     | peso kg |
|--------------|---------|
| <b>20929</b> | 0,12    |

# Abbacchiatori Elettrici

## ELECTRIC OLIVE HARVESTERS

# 16

16

### ABBACCHIATORE ELETTRICO OLIVEST

VIBREUR ELECTRIQUE  
ELECTRIC OLIVE HARVESTER  
ELEKTRISCHE BAUMRÜTTLER  
SACUDIDOR ELÉCTRICO

new



 **MADE IN ITALY**

#### CARATTERISTICHE

L'abbacchiatore elettrico per la raccolta delle olive OLIVEST è l'evoluzione degli abbacchiatori pneumatici per facilitare e rendere l'operatore libero di muoversi senza difficoltà tra gli oliveti, ma senza perdere la capacità di raccolta degli abbacchiatori pneumatici. Il nostro abbacchiatore elettrico OLIVEST è il più veloce degli abbacchiatori elettrici in commercio con 1500 battiti al minuto, frutto di un potente motore a 12V.

È un prodotto elettrico professionale per la raccolta delle olive con pettini a rastrello contrapposti con rebbi-astine intercambiabili per ridurre il costo delle riparazioni, evitando la sostituzione di tutto il pettine.

#### CAVO 15 METRI IN DOTAZIONE



| ARTICOLO     | battiti/min | VOLT | WATT | LUNGHEZZA ASTA<br>m | PESO<br>kg |
|--------------|-------------|------|------|---------------------|------------|
| <b>20724</b> | 1500        | 12   | 80   | 1.45 – 2.25 m       | 2,8        |

### ABBACCHIATORE ELETTRICO OLIVCER

VIBREUR ELECTRIQUE  
ELECTRIC OLIVE HARVESTER  
ELEKTRISCHE BAUMRÜTTLER  
SACUDIDOR ELÉCTRICO



 **MADE IN ITALY**



#### CARATTERISTICHE

L'abbacchiatore elettrico OLIVCER è realizzato per soddisfare la raccolta dell'oliva. E' una macchina adatta per i piccoli e medi appezzamenti potati di media vegetazione. Il moto e la conformazione dei rastrelli permettono ottimi raccolti su tutte le varietà d'olivo. Equipaggiato con asta telescopica e relativo sistema di bloccaggio, è azionato da un motore 12V comandato da un interruttore ON/OFF posto sull'impugnatura e dotato di sistema di sicurezza.

**DOTAZIONE:** Cavo di prolunga da 15 m.

#### FEATURES

The OLIVCER electric picking machine is designed for olive harvesting. It is suitable for small and medium-sized, pruned to medium vegetation. The motor and the layout of the rakes provide for optimum yields for all olive varieties. Equipped with a telescopic pole and relevant locking mechanism, it is powered by a 12V motor operated by an ON/OFF switch on the handle, and comes with a safety system.

**EQUIPMENT:** 15 m extension cable.



#### CAVO 15 METRI IN DOTAZIONE



| ARTICOLO     | battiti/min | VOLT | ASSORBIMENTO<br>Ah | BATTERIA<br>Ah | LUNGHEZZA<br>m | PESO<br>kg |
|--------------|-------------|------|--------------------|----------------|----------------|------------|
| <b>20918</b> | 1100        | 12   | 6/8                | 60             | 2,2 ÷ 3,1      | 2,7        |

### KIT PETTINE DI RICAMBIO PER 20918

RÂTEAU DE REMPLACEMENT POUR 20918  
SPARE RAKE FOR 20918  
ERSATZRECHENKIT FUER 20918  
RASTRILLO DE RECAMBIO PARA 20918



ARTICOLO  
**20935**

### KIT CARBONCINI DI RICAMBIO PER 20918

JEU DE CHARBONS DE REMPLACEMENT POUR 20918  
SPARE COALS KIT FOR 20918  
ERSATZKOHLENSTOFFTEILE FUER 20918  
JUEGO DE CARBONCITOS DE RECAMBIO PARA 20918



ARTICOLO  
**20936**

### INTERRUPTORE DI RICAMBIO PER 20918

INTERRUPTEUR DE REMPLACEMENT POUR 20918  
SPARE SWITCH FOR 20918  
ERSATZSCHALTER FUER 20918  
INTERRUPTOR DE RECAMBIO PARA 20918



ARTICOLO  
**20937**

### KIT CONNETTORI DI RICAMBIO PER 20918 E 20919

JEU DE CONNECTEURS DE REMPLACEMENT POUR 20918  
SPARE CONNECTORS KIT FOR 20918  
ERSATZVERBINDERKIT FUER 20918 UND 20919  
JUEGO DE CONECTORES DE RECAMBIO PARA 20918



ARTICOLO  
**20938**

# Abbacchiatori Elettrici

## ELECTRIC OLIVE HARVESTERS

# 16

16

### ABBACCHIATORE ELETTRICO OLIVCER PLUS

VIBREUR ELECTRIQUE  
ELECTRIC OLIVE HARVESTER  
ELEKTRISCHE BAUMRÜTTLER  
SACUDIDOR ELÉCTRICO



 **MADE IN ITALY**



### CARATTERISTICHE

L'abbacchiatore elettrico OLIVCER Plus è realizzato per soddisfare la raccolta "professionale" dell'oliva. Si tratta di una macchina adatta ad operare su varie tipologie d'olivi con vegetazioni più o meno curate. Conformazione e movimento laterali dei pettini assicurano ottimi raccolti. La macchina, molto bilanciata, è composta dal gruppo testa, asta telescopica con relativo sistema di bloccaggio e dall'impugnatura nella quale è situato il motore 12V/riduttore e l'interruttore ON/OFF dotato di sistema di sicurezza.

**DOTAZIONE:** Cavo di prolunga da 15 m.

### FEATURES

The OLIVCER Plus electric picking machine is designed for "professional" olive harvesting. This machine is suitable for working on various types of olive trees, with generally trimmed vegetation. The layout and sideways movement of the rakes ensure optimum yields. The machine is well balanced, and is made up of a header group, a telescopic pole with locking mechanism and handle, where the 12V motor/transformer and ON/OFF switch are located. It also has a safety system.

**EQUIPMENT:** 15 m extension cable.

### CAVO 15 METRI IN DOTAZIONE

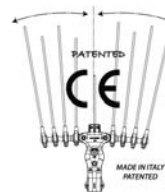

| ARTICOLO | battiti/min | VOLT | ASSORBIMENTO<br>Ah | BATTERIA<br>Ah | LUNGHEZZA<br>m | PESO<br>kg |
|----------|-------------|------|--------------------|----------------|----------------|------------|
| ▶ 20998  | 1200        | 12   | 6/8                | 60             | 1,7 ÷ 2,2      | 2,5        |
| 20919    | 1200        | 12   | 6/8                | 60             | 2,2 ÷ 3,1      | 2,7        |

### KIT CARBON FLEX DI RICAMBIO PER 20919

KIT CARBON FLEX DE REMPLACEMENT POUR 20919  
SPARE CARBON FLEX KIT FOR 20919  
ERSATZTEILE KIT AUS KOHLENSTOFF FUER 20919  
JUEGO CARBON FLEX DE RECAMBIO PARA 20919



ARTICOLO  
**20940**

### KIT CARBONCINI DI RICAMBIO PER 20919

JEU DE CHARBONS DE REMPLACEMENT POUR 20919  
SPARE COALS KIT FOR 20919  
ERSATZKOHLENSTOFFTEILE FUER 20919  
JUEGO DE CARBONCITOS DE RECAMBIO PARA 20919



ARTICOLO  
**20941**

### INTERRUTTORE DI RICAMBIO PER 20919

INTERRUPTEUR DE REMPLACEMENT POUR 20919  
SPARE SWITCH FOR 20919  
ERSATZSCHALTER FUER 20919  
INTERRUPTOR DE RECAMBIO PARA 20919



ARTICOLO  
**20942**

### ASTA IN CARBONIO DI RICAMBIO PER 20919

CANNE DE CARBONE DE REMPLACEMENT POUR 20919  
SPARE CARBON ROD FOR 20919  
ERSATZKOHLENSTOFFSTANGE FUER 20919  
VARA DE CARBONO DE RECAMBIO PARA 20919

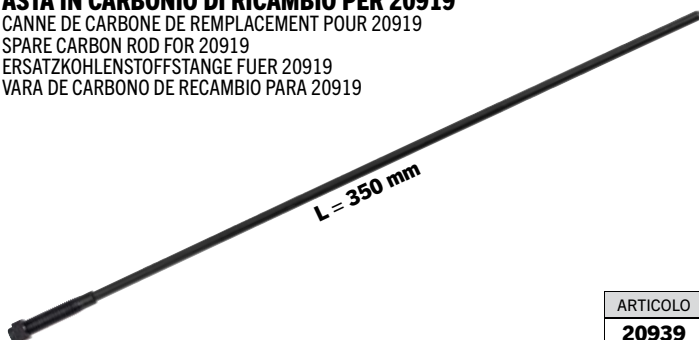

ARTICOLO  
**20939**

### KIT CONNETTORI DI RICAMBIO PER 20918 E 20919

JEU DE CONNECTEURS DE REMPLACEMENT POUR 20918  
SPARE CONNECTORS KIT FOR 20918  
ERSATZVERBINDERKIT FUER 20918 UND 20919  
JUEGO DE CONECTORES DE RECAMBIO PARA 20918



ARTICOLO  
**20938**



### ABBACCHIATORE ELETTRICO OLIVGREEN 700 PLUS

VIBREUR ELECTRIQUE  
ELECTRIC OLIVE HARVESTER  
ELEKTRISCHE BAUMRÜTTLER  
SACUDIDOR ELÉCTRICO

new



MADE IN ITALY



#### CARATTERISTICHE

L'abbacchiatore elettrico Olivgreen 700 Plus è realizzato per soddisfare la raccolta "professionale" dell'oliva. Si tratta di una macchina adatta ad operare su alberi dal frutto di calibro medio piccolo, di media vegetazione. Il moto ellittico e contrapposto del doppio pettine assicura ottimi raccolti senza defogliare eccessivamente. La macchina, molto bilanciata, è composta dal gruppo testa, asta telescopica con relativo sistema di bloccaggio e dall'impugnatura nella quale è situato il motore 12V/riduttore e l'interruttore ON/OFF dotato di sistema di sicurezza.

**DOTAZIONE:** Cavo di prolunga da 15 m.

#### FEATURES

The Olivgreen 700 Plus electric picking machine is designed for "professional" olive harvesting. It is a machine suitable for use on trees with mid-to-small sized fruit, with medium vegetation. The elliptic and counter-positioned double rake ensures optimum yields without removing too many leaves. The machine is well balanced, and is made up of a header group, a telescopic pole with locking mechanism and handle, where the 12V motor/transformer and ON/OFF switch are located. It also has a safety system.

**EQUIPMENT:** 15 m extension cable.

#### CAVO 15 METRI IN DOTAZIONE

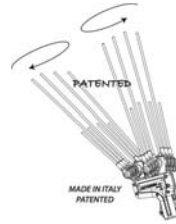

| ARTICOLO     | giri/min | VOLT | ASSORBIMENTO Ah | BATTERIA Ah | LUNGHEZZA m | PESO kg |
|--------------|----------|------|-----------------|-------------|-------------|---------|
| <b>21000</b> | 1200     | 12   | 6/8             | 60/80       | 2,2 - 3,1   | 2,7     |

#### KIT CARBONCINI DI RICAMBIO

JEU DE CHARBONS DE REMPLACEMENT  
SPARE COALS KIT  
ERSATZKOHLENSTOFFTEILE  
JUEGO DE CARBONCITOS DE RECAMBIO



ARTICOLO  
**20941**

#### KIT CONNETTORI DI RICAMBIO

JEU DE CONNECTEURS DE REMPLACEMENT  
SPARE CONNECTORS KIT  
ERSATZVERBINDERKIT  
JUEGO DE CONECTORES DE RECAMBIO



ARTICOLO  
**20938**

#### INTERRUTTORE DI RICAMBIO

INTERRUPTEUR DE REMPLACEMENT  
SPARE SWITCH  
ERSATZSCHALTER  
INTERRUPTOR DE RECAMBIO



ARTICOLO  
**20942**

#### KIT CONNETTORE CON CAVETTO

KIT CONNECTEUR AVEC CÂBLE  
CONNECTOR KIT WITH CABLE  
KIT STECKER MIT KABEL  
KIT CONECTOR CON CABLE



new

ARTICOLO  
**21012**

#### ASTA IN CARBONIO DI RICAMBIO

CANNE DE CARBONE DE REMPLACEMENT  
SPARE CARBON ROD  
ERSATZKOHLENSTOFFSTANGE  
VARA DE CARBONO DE RECAMBIO



ARTICOLO  
**20939**

#### ASTA IN CARBONIO DI RICAMBIO

CANNE DE CARBONE DE REMPLACEMENT  
SPARE CARBON ROD  
ERSATZKOHLENSTOFFSTANGE  
VARA DE CARBONO DE RECAMBIO

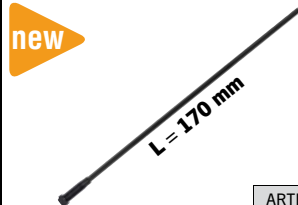

new

ARTICOLO  
**21013**

#### KIT PIASTRINA BRZ

KIT PLAQUE BRZ  
PLATE KIT BRZ  
KIT PLÄTTCHEN BRZ  
KIT PLACA BRZ



new

ARTICOLO  
**21014**

#### KIT CARBONFLEX 700

KIT CARBONFLEX 700  
CARBONFLEX 700 KIT  
KIT CARBONFLEX 700  
KIT CARBONFLEX 700



new

ARTICOLO  
**21015**

# Abbacchiatori Elettrici

## ELECTRIC OLIVE HARVESTERS

# 16

### 16 BATTERIA AL LITIO A SPALLA PER ABBACCHIATORI ELETTRICI

BATTERIE DE LITHIUM POUR VIBREURS ELECTRIQUES  
BACK PACK LITHIUM BATTERY FOR ELECTRIC OLIVE HARVESTER  
LITHIUM BATTERIE FUER OLIVENSCHUETTLER  
BATERIA DE LITIO PARA SACUIDIDORES ELECTRICOS

 **MADE IN ITALY**



#### CARICA BATTERIA IN DOTAZIONE



| ARTICOLO     | VOLT | BATTERIA Ah | RICARICA h | OPERATIVITÀ h | BATTERIA | PESO kg |
|--------------|------|-------------|------------|---------------|----------|---------|
| <b>20949</b> | 12   | 45          | 6          | 7/8           | Li-ion   | 3,5     |

### GENERATORE CON INVERTER RATO R2000 1,6 KW

GÉNÉRATEUR AVEC ONDULEUR RATO R2000 1,6 KW  
 RATO R2000 GENERATOR WITH INVERTER 1.6 KW  
 GENERATOR MIT WECHSELRICHTER RATO R2000 1,6 KW  
 GENERADOR CON INVERSOR RATO R2000 1,6 KW

new



Presa USB

#### ACCESSORI

 Kit connettori  
 per generatore 78218

**78220**

#### CARATTERISTICHE MOTORE - ENGINE FEATURES

- Tipo - Type.....4 tempi, raffreddamento ad aria, 1 cilindro, valvole in testa  
4W-stroke, Air-cooled, single cylinder, OHV
- Carburante - Fuel .....Benzina verde / Gasoline
- Cilindrata - Displacement.....79,7 cc
- Avviamento - Starter .....Autoavvolgente / Recoil starter

#### CARATTERISTICHE GENERATORE - GENERATOR FEATURES

- Tipo - Type..... Inverter
- Frequenza - Frequency ..... 50 Hz
- Tensione nominale - Rated voltage ..... 230 V
- Potenza nominale - Rated power .....1,6 kW
- Potenza massima - Max power .....1,8 kW
- Capacità serbatoio - Fuel tank capacity ..... 3,5 litri / litres
- Autonomia max potenza - Full load continuum running time ..... 3,5 ore / hours
- Autonomia mezzo carico - 1/2 Load continuum running time ..... 5,2 ore / hours
- Rumorosità - Noise ..... 65 dB
- Dimensioni LxLxH - Dimensions LxWxH.....420x280x420 mm
- Peso - Weight ..... 17,5 kg
- Prese - Sockets..... 2x Schuko 16A
- Uscita DC - DC Output ..... 12 V / 8,3 A, USB
- Protezione olio - Oil alert
- Protezione da sovraccarico - Overload protection
- Funzione parallelo - Parallel function

ARTICOLO

**78218**

### GENERATORE CON INVERTER RATO R3000 3,2 KW

GÉNÉRATEUR AVEC ONDULEUR RATO R3000 3,2 KW  
 RATO R3000 GENERATOR WITH INVERTER 3.2 KW  
 GENERATOR MIT WECHSELRICHTER RATO R3000 3,2 KW  
 GENERADOR CON INVERSOR RATO R3000 3,2 KW

new



Presa USB

 Avviamento Elettrico  
 Electrical Starter

#### ACCESSORI

 Kit connettori  
 per generatore 78219

**78221**

#### CARATTERISTICHE MOTORE - ENGINE FEATURES

- Tipo - Type.....4 tempi, raffreddamento ad aria, 1 cilindro, valvole in testa  
4W-stroke, Air-cooled, single cylinder, OHV
- Carburante - Fuel .....Benzina verde / Gasoline
- Cilindrata - Displacement.....212 cc
- Avviamento - Starter .....Recoil elettrico / Recoil electric with battery

#### CARATTERISTICHE GENERATORE - GENERATOR FEATURES

- Tipo - Type..... Inverter
- Frequenza - Frequency ..... 50 Hz
- Tensione nominale - Rated voltage ..... 230 V
- Potenza nominale - Rated power .....3,2 kW
- Potenza massima - Max power .....3,5 kW
- Capacità serbatoio - Fuel tank capacity ..... 8,3 litri / litres
- Autonomia max potenza - Full load continuum running time ..... 5 ore / hours
- Autonomia mezzo carico - 1/2 Load continuum running time ..... 8,5 ore / hours
- Rumorosità - Noise ..... 66 dB
- Dimensioni LxLxH - Dimensions LxWxH.....590x456x511 mm
- Peso - Weight ..... 45 kg
- Prese - Sockets..... 2x Schuko 16A
- Uscita DC - DC Output ..... 12 V / 8,3 A, USB
- Protezione olio - Oil alert
- Protezione da sovraccarico - Overload protection
- Livello carburante - Fuel meter
- Funzione parallelo - Parallel function

ARTICOLO

**78219**

16

### MOTOTRIVELLA A SCOPPIO 42,7 CC

TARIÈRE THERMIQUE MOTORISÉE 42,7 CC  
42.7 CC PETROL-DRIVEN AUGER  
MOTORBOHRER MIT BENZINMOTOR 42,7 CC  
MOTOPERFORADORA DE EXPLOSIÓN 42,7 CC

new



#### CARATTERISTICHE

- Manopola multifunzione
- Manopole antivibranti
- Manicotto guida aria

#### FEATURES

- Multifunction Handle
- Anti-vibration Handle
- Air Guide Sleeve

| ARTICOLO     | CILINDRATA | POTENZA | CAPACITÀ SERBATOIO |
|--------------|------------|---------|--------------------|
| <b>78202</b> | 42,7 cc    | 1,2 kW  | 0,98 l             |

### PUNTA PER MOTOTRIVELLA Ø 80

MÈCHE POUR TARIÈRE MOTORISÉE Ø 80  
AUGER BIT Ø 80  
BOHRAUFSATZ FÜR MOTORBOHRER Ø 80  
PUNTA PARA MOTOPERFORADORA Ø 80

new



ARTICOLO  
**78203**

### PUNTA PER MOTOTRIVELLA Ø 100

MÈCHE POUR TARIÈRE MOTORISÉE Ø 100  
AUGER BIT Ø 100  
BOHRAUFSATZ FÜR MOTORBOHRER Ø 100  
PUNTA PARA MOTOPERFORADORA Ø 100

new



ARTICOLO  
**78204**

### PUNTA PER MOTOTRIVELLA Ø 150

MÈCHE POUR TARIÈRE MOTORISÉE Ø 150  
AUGER BIT Ø 150  
BOHRAUFSATZ FÜR MOTORBOHRER Ø 150  
PUNTA PARA MOTOPERFORADORA Ø 150

new



ARTICOLO  
**78205**

### PUNTA PER MOTOTRIVELLA Ø 200

MÈCHE POUR TARIÈRE MOTORISÉE Ø 200  
AUGER BIT Ø 200  
BOHRAUFSATZ FÜR MOTORBOHRER Ø 200  
PUNTA PARA MOTOPERFORADORA Ø 200

new



ARTICOLO  
**78206**

### PROLUNGA PUNTA PER MOTOTRIVELLA

RALLONGE MÈCHE POUR TARIÈRE MOTORISÉE  
AUGER DRILL BIT EXTENSION  
VERLÄNGERUNG BOHRAUFSATZ FÜR MOTORBOHRER  
EXTENSION PUNTA PARA MOTOPERFORADORA

new



ARTICOLO  
**78207**

### MOTORE AD ALBERO ORIZZONTALE RATO EHR80 4T

MOTEUR À ARBRE HORIZONTAL RATO EHR80 4T  
 RATO EHR80 4T HORIZONTAL SHAFT MOTOR  
 MOTOR MIT HORIZONTALER WELLE RATO EHR80 4T  
 MOTOR DE EJE HORIZONTAL RATO EHR80 4T

new



#### CARATTERISTICHE - FEATURES

- Cilindrata - Displacement..... 78,5 cc (2,3 HP)
- Carburante - Fuel..... Benzina / Gasoline
- Potenza - Power..... 1,7 kW / 3600 rpm
- Coppia - Torque..... 4,5 N.m. / 3600 rpm
- Albero motore - PTO shaft dimension..... 15 mm - metric
- Filtro aria - Air filter element..... doppio elemento - dual
- Canna del cilindro in ghisa - Cast iron cylinder
- Tipo olio - Oil type..... SAE5W/30-SJ
- Capacità serbatoio - Fuel tank capacity liters..... 1,8 l
- Capacità coppa olio - Lubricating oil capacity liters..... 0,35 l
- Dimensioni di massima LxLxH - Dimensions LxWxH..... 310 x 290 x 320 mm
- Transistor protezione olio - Oil alert

ARTICOLO

**78208**

### MOTORE AD ALBERO ORIZZONTALE RATO EHR180 4T

MOTEUR À ARBRE HORIZONTAL RATO EHR180 4T  
 RATO EHR180 4T HORIZONTAL SHAFT MOTOR  
 MOTOR MIT HORIZONTALER WELLE RATO EHR180 4T  
 MOTOR DE EJE HORIZONTAL RATO EHR180 4T

new



#### CARATTERISTICHE - FEATURES

- Cilindrata - Displacement..... 179 cc (5 HP)
- Carburante - Fuel..... Benzina / Gasoline
- Potenza - Power..... 3,8 kW / 3600 rpm
- Coppia - Torque..... 9,5 N.m. / 2500 rpm
- Albero motore - PTO shaft dimension..... cilindrico 3/4" 19,5mm- SAE 3/4
- Filtro aria - Air filter element..... doppio elemento - dual
- Canna del cilindro in ghisa - Cast iron cylinder
- Tipo olio - Oil type..... SAE5W/30-SJ
- Capacità serbatoio - Fuel tank capacity liters..... 3,6 l
- Capacità coppa olio - Lubricating oil capacity liters..... 0,55 l
- Dimensioni di massima LxLxH - Dimensions LxWxH..... 390 x 320 x 345 mm
- Transistor protezione olio - Oil alert

ARTICOLO

**78209**

### MOTORE AD ALBERO ORIZZONTALE RATO R210 4T

MOTEUR À ARBRE HORIZONTAL RATO R210 4T  
 RATO R210 4T HORIZONTAL SHAFT MOTOR  
 MOTOR MIT HORIZONTALER WELLE RATO R210 4T  
 MOTOR DE EJE HORIZONTAL RATO R210 4T

new



#### CARATTERISTICHE - FEATURES

- Cilindrata - Displacement..... 212 cc (6 HP)
- Carburante - Fuel..... Benzina / Gasoline
- Potenza - Power..... 4,4 kW / 3600 rpm
- Coppia - Torque..... 12 N.m. / 2500 rpm
- Albero motore - PTO shaft dimension..... cono nazionale - taper Ø 23
- Filtro aria - Air filter element..... bagno d'olio - oil bath
- Canna del cilindro in ghisa - Cast iron cylinder
- Tipo olio - Oil type..... SAE5W/30-SJ
- Capacità serbatoio - Fuel tank capacity liters..... 3,6 l
- Capacità coppa olio - Lubricating oil capacity liters..... 0,55 l
- Dimensioni di massima LxLxH - Dimensions LxWxH..... 390 x 320 x 345 mm
- Transistor protezione olio - Oil alert

ARTICOLO

**78210**

16

### MOTORE AD ALBERO ORIZZONTALE RATO R300 4T

MOTEUR À ARBRE HORIZONTAL RATO R300 4T  
 RATO R300 4T HORIZONTAL SHAFT MOTOR  
 MOTOR MIT HORIZONTALER WELLE RATO R300 4T  
 MOTOR DE EJE HORIZONTAL RATO R300 4T

new



#### CARATTERISTICHE - FEATURES

- Cilindrata - Displacement..... 301 cc (8 HP)
- Carburante - Fuel..... Benzina / Gasoline
- Potenza - Power..... 6 kW / 3600 rpm
- Coppia - Torque..... 19 N.m. / 2500 rpm
- Albero motore - PTO shaft dimension..... cono nazionale - taper Ø 23
- Filtro aria - Air filter element..... bagno d'olio - oil bath
- Canna del cilindro in ghisa - Cast iron cylinder
- Tipo olio - Oil type..... SAE5W/30-SJ
- Capacità serbatoio - Fuel tank capacity liters..... 5,4 l
- Capacità coppa olio - Lubricating oil capacity liters..... 1,1 l
- Dimensioni di massima LxLxH - Dimensions LxWxH..... 420 x 395 x 430 mm
- Transistor protezione olio - Oil alert

ARTICOLO

**78211**

### MOTORE AD ALBERO ORIZZONTALE RATO R420 4T

MOTEUR À ARBRE HORIZONTAL RATO R420 4T  
 RATO R420 4T HORIZONTAL SHAFT MOTOR  
 MOTOR MIT HORIZONTALER WELLE RATO R420 4T  
 MOTOR DE EJE HORIZONTAL RATO R420 4T

new



#### CARATTERISTICHE - FEATURES

- Cilindrata - Displacement..... 420 cc (12 HP)
- Carburante - Fuel..... Benzina / Gasoline
- Potenza - Power..... 8,8 kW / 3600 rpm
- Coppia - Torque..... 26,5 N.m. / 2500 rpm
- Albero motore - PTO shaft dimension..... cono nazionale - taper Ø 23
- Filtro aria - Air filter element..... bagno d'olio - oil bath
- Canna del cilindro in ghisa - Cast iron cylinder
- Tipo olio - Oil type..... SAE5W/30-SJ
- Capacità serbatoio - Fuel tank capacity liters..... 6,5 l
- Capacità coppa olio - Lubricating oil capacity liters..... 1,1 l
- Dimensioni di massima LxLxH - Dimensions LxWxH..... 465 x 415 x 440 mm

ARTICOLO

**78212**

### MOTOPOMPA AUTOADESCANTE RATO RT25 PER ACQUE CHIARE

MOTOPOMPE AUTO-AMORÇANTE RATO RT25 POUR EAUX CLAIRES  
 RATO RT25 SELF-PRIMING MOTOR PUMP FOR CLEAR WATER  
 SELBSTANSAUGENDE MOTORPUMPE RATO RT25 FÜR KLARWASSER  
 MOTOBOMBA AUTOCEBANTE RATO RT25 PARA AGUAS BLANCAS

new



#### CARATTERISTICHE - FEATURES

- Tipo - Type..... 4 tempi, raffreddamento ad aria / 4-stroke, Air-cooled
- Carburante - Fuel..... Benzina / Gasoline
- Cilindrata - Displacement..... 78,5 ml
- Aspirazione - Suction port..... Ø 25 (1")
- Mandata - Discharge port..... Ø 25 (1")
- Capacità aspirazione - Suction head lift..... 6 m
- Prevalenza massima - Total head lift..... 28 m
- Portata massima - Discharge capacity..... 133 l/min
- Dimensioni LxLxH - Dimensions LxWxH..... 385x285x375 mm
- Peso - Weight..... 12,5 kg
- Sensore Olio - oil Sensor

ARTICOLO

**78213**

### MOTOPOMPA AUTOADESCANTE RATO RT40 PER ACQUE CHIARE

MOTOPOMPE AUTO-AMORÇANTE RATO RT40 POUR EAUX CLAIRES  
 RATO RT40 SELF-PRIMING MOTOR PUMP FOR CLEAR WATER  
 SELBSTANSAUGENDE MOTORPUMPE RATO RT40 FÜR KLARWASSER  
 MOTOBOMBA AUTOCEBANTE RATO RT40 PARA AGUAS BLANCAS

new



#### CARATTERISTICHE - FEATURES

- Tipo - Type..... 4 tempi, raffreddamento ad aria / 4-stroke, Air-cooled
- Carburante - Fuel..... Benzina / Gasoline
- Cilindrata - Displacement..... 78,5 ml
- Aspirazione - Suction port..... Ø 40 (1,5")
- Mandata - Discharge port..... Ø 40 (1,5")
- Capacità aspirazione - Suction head lift..... 6 m
- Prevalenza massima - Total head lift..... 16 m
- Portata massima - Discharge capacity..... 233 l/min
- Dimensioni LxLxH - Dimensions LxWxH..... 355x285x385 mm
- Peso - Weight..... 12,5 kg
- Sensore Olio - oil Sensor

ARTICOLO

**78214**

### MOTOPOMPA AUTOADESCANTE RATO RT50 PER ACQUE CHIARE

MOTOPOMPE AUTO-AMORÇANTE RATO RT50 POUR EAUX CLAIRES  
 RATO RT50 SELF-PRIMING MOTOR PUMP FOR CLEAR WATER  
 SELBSTANSAUGENDE MOTORPUMPE RATO RT50 FÜR KLARWASSER  
 MOTOBOMBA AUTOCEBANTE RATO RT50 PARA AGUAS BLANCAS

new



#### CARATTERISTICHE - FEATURES

- Tipo - Type..... 4 tempi, raffreddamento ad aria / 4-stroke, Air-cooled
- Carburante - Fuel..... Benzina / Gasoline
- Cilindrata - Displacement..... 212 ml
- Aspirazione - Suction port..... Ø 50 (2")
- Mandata - Discharge port..... Ø 50 (2")
- Capacità aspirazione - Suction head lift..... 8 m
- Prevalenza massima - Total head lift..... 28 m
- Portata massima - Discharge capacity..... 600 l/min
- Dimensioni LxLxH - Dimensions LxWxH..... 477x395x410 mm
- Peso - Weight..... 23,5 kg
- Sensore Olio - oil Sensor

ARTICOLO

**78215**

### POMPE OLIO PER MOTOSEGHE

POMPES A HUILE POUR TRONÇONNEUSES - OIL PUMPS FOR MOTOR SAWS - ÖLPUMPEN FÜR MOTORSÄGEN - BOMBAS ACEITE PARA SIERRAS ELÉCTRICAS



| ARTICOLO     | APPLICAZIONI   | OEM         |
|--------------|--|-------------|
| <b>12440</b> | ECHO 302-304-315-330-351-360-400-440-452-500-550-650-650 2°SERIE-660 | 43700-20343 |



| ARTICOLO     | APPLICAZIONI  | OEM  |
|--------------|---|--|
| <b>12441</b> | HUSQVARNA 36-41-136 - 137 - 141 - 146<br>JONSERED 2036-2040 | albero<br>530 02 98-38<br>corpo<br>530 02 98- 34 |



| ARTICOLO     | APPLICAZIONI                                      | OEM                    |
|--------------|---|------------------------|
| <b>12442</b> | HUSQVARNA 40 - 45 - 49<br>JONSERED 2041-2045-2050 | albero<br>509 02 39-01 |



| ARTICOLO     | APPLICAZIONI       | OEM                    |
|--------------|--------------------|------------------------|
| <b>12443</b> | HUSQVARNA 50-51-55 | albero<br>503 66 01-02 |



**12841**



**13068**

| OEM albero   | OEM corpo     | OEM vite     |
|--------------|---------------|--------------|
| 503 93 21-01 | 537 15 48-014 | 503 93 18-01 |

| ARTICOLO     | DESCRIZIONE               | APPLICAZIONI                      |
|--------------|---------------------------|-----------------------------------|
| <b>12841</b> | Pompa olio                | HUSQVARNA 135 - 340 - 345 - 435 - |
| <b>13068</b> | Vite senza fine (7 denti) | 440 - 445 - 450                   |



| ARTICOLO     | APPLICAZIONI                  | OEM     |
|--------------|-------------------------------|---------|
| <b>12446</b> | OLEOMAC 350 - 935<br>EFCO 135 | 9350460 |



### segue POMPE OLIO PER MOTOSEGHE

POMPES A HUILE POUR TRONÇONNEUSES - OIL PUMPS FOR MOTOR SAWS - ÖLPUMPEN FÜR MOTORSÄGEN - BOMBAS ACEITE PARA SIERRAS ELÉCTRICAS



**12878**



**12879**

| ARTICOLO     | DESCRIZIONE     | APPLICAZIONI   |
|--------------|-----------------|--|
| <b>12878</b> | Pompa olio      | ZENOAH G250-G2500-G3300-G3800-GZ3500 (tipo nuovo)        |
| <b>12879</b> | Vite senza fine | OLEOMAC 925-GS260<br>HUSQVARNA T425-T435<br>ALPINA PR270 |



**12447**



**12967**

| ARTICOLO     | DESCRIZIONE               | APPLICAZIONI  |
|--------------|---------------------------|---|
| <b>12447</b> | Pompa olio                | ZENOAH G250-2500 (tipo vecchio) OEM: Z284155112<br>ALPINA CP270-A3700-A4000-P5338<br>OEM: 383594507/0 |
| <b>12967</b> | Vite senza fine (2 denti) | ZENOAH G2500 (tipo vecchio)<br>OEM: 11855060670   |

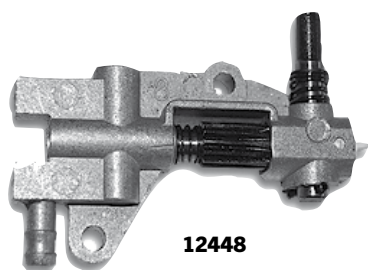

**12448**



**12640**

| OEM pompa  | OEM vite   |
|------------|------------|
| Z288055100 | Z267055120 |

| ARTICOLO     | DESCRIZIONE     | APPLICAZIONI       |
|--------------|-----------------|--------------------|
| <b>12448</b> | Pompa olio      | ZENOAH 415-455-500 |
| <b>12640</b> | Vite senza fine |                    |



| ARTICOLO     | ∅    | APPLICAZIONI                     |
|--------------|------|----------------------------------|
| <b>12632</b> | 9 mm | ALPINA P360 - P370 - P390 - P410 |



**12946**



**12958**

| ARTICOLO     | DESCRIZIONE     | APPLICAZIONI      | OEM          |
|--------------|-----------------|-------------------|--------------|
| <b>12946</b> | Pompa olio      | HUSQVARNA 61 - 66 | 501 51 25-01 |
| <b>12958</b> | Vite senza fine | - 266             | 501 51 38-01 |



**12944**



**12971**



**12972**



**12973**

| ARTICOLO     | DESCRIZIONE     | APPLICAZIONI   | OEM          |
|--------------|-----------------|--|--------------|
| <b>12944</b> | Pompa olio      | HUSQVARNA 346 - 350 - 353 - 357 - 359<br>JONSERED 2041 - 2140 - 2145 - 2147 - 2150 - 2156 - 2159 | 537 10 55-03 |
| <b>12971</b> | Vite senza fine | HUSQVARNA 350  | 503 89 22-02 |
| <b>12972</b> | Vite senza fine | HUSQVARNA 346 - 353  | 503 89 21-02 |
| <b>12973</b> | Vite senza fine | HUSQVARNA 357 - 359  | 503 91 29-02 |

### segue POMPE OLIO PER MOTOSEGHE

POMPES A HUILE POUR TRONÇONNEUSES - OIL PUMPS FOR MOTOR SAWS - ÖLPUMPEN FÜR MOTORSÄGEN - BOMBAS ACEITE PARA SIERRAS ELÉCTRICAS



**12947**



**12959**



**12960**

| ARTICOLO     | DESCRIZIONE     | FORO Ø FRONT. | FORO Ø POST. | APPLICAZIONI  | OEM         |
|--------------|-----------------|---------------|--------------|---|-------------|
| <b>12947</b> | Pompa olio      | 20 mm         | 20 mm        | ECHO CS260 - CS270 (tipo nuovo)                                 | C0220-00020 |
| <b>12959</b> | Vite senza fine | -             | -            | SHINDAIWA 269TS - 280TS - 280TCS - 320TS - 358TS - 360TS - 402S | V6520-00230 |
| <b>12960</b> | Vite senza fine | -             | -            | ECHO CS370 - CS360 - CS350 - CS280 - CS320                      | V6520-00030 |

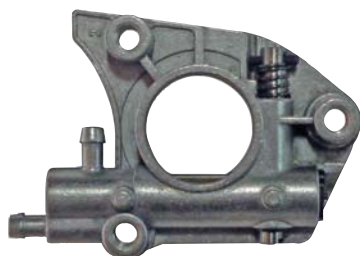

**12949**



**13272**

**12961**

**12960**

| ARTICOLO     | DESCRIZIONE     | APPLICAZIONI               | OEM          |
|--------------|-----------------|----------------------------|--------------|
| <b>12949</b> | Pompa olio      | ECHO CS440 - CS3500 -      | 437002-38330 |
| <b>12961</b> | Vite senza fine | CS3700 - CS3800 - CS4200 - | V6520-00021  |
| <b>13272</b> | Vite senza fine | CS4400 - CS5100            |              |
| <b>12960</b> | Vite senza fine | ECHO CS420 - CS450         |              |



**12950**



**12962**

| ARTICOLO     | DESCRIZIONE          | APPLICAZIONI      |
|--------------|----------------------|-------------------|
| <b>12950</b> | Pompa olio           | STIHL 038 - MS380 |
| <b>12962</b> | Vite senza fine Z.22 |                   |



**12951**



**12963**

| ARTICOLO     | DESCRIZIONE     | APPLICAZIONI              | OEM           |
|--------------|-----------------|---------------------------|---------------|
| <b>12951</b> | Pompa olio      | STIHL 024 - MS240 - 026 - | 1121 640 3203 |
| <b>12963</b> | Vite senza fine | MS260                     | 1121 640 7111 |

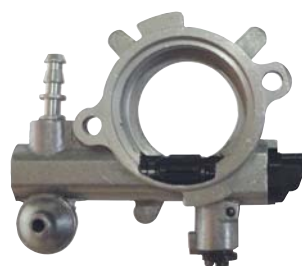

**12952**



**12964**

| ARTICOLO     | DESCRIZIONE     | APPLICAZIONI                  | OEM          |
|--------------|-----------------|-------------------------------|--------------|
| <b>12952</b> | Pompa olio      | STIHL 029 - 034 - 036 - 039 - | 1125 6403201 |
| <b>12964</b> | Vite senza fine | MS290 - MS360 - MS340 - MS390 | 11256407110  |



**12953**



**12965**

| ARTICOLO     | DESCRIZIONE     | APPLICAZIONI              | OEM           |
|--------------|-----------------|---------------------------|---------------|
| <b>12953</b> | Pompa olio      | STIHL 044 - 046 - MS441 - | 1128 640 3206 |
| <b>12965</b> | Vite senza fine | MS460 - MS461             | 1128 640 7100 |



**12954**



**12966**

| ARTICOLO     | DESCRIZIONE     | APPLICAZIONI              | OEM           |
|--------------|-----------------|---------------------------|---------------|
| <b>12954</b> | Pompa olio      | STIHL 021 - MS210 - 023 - | 1123 640 3200 |
| <b>12966</b> | Vite senza fine | MS230 - 025 - MS250       | 1123 640 7105 |

### segue POMPE OLIO PER MOTOSEGHE

POMPES A HUILE POUR TRONÇONNEUSES - OIL PUMPS FOR MOTOR SAWS - ÖLPUMPEN FÜR MOTORSÄGEN - BOMBAS ACEITE PARA SIERRAS ELÉCTRICAS



**12955**



**12968**

| ARTICOLO     | DESCRIZIONE            | APPLICAZIONI  | OEM         |
|--------------|------------------------|---------------|-------------|
| <b>12955</b> | Pompa olio + vite s.f. | ZENOAH G2000T | Z542301888  |
| <b>12968</b> | Vite senza fine        |               | Z848C006751 |

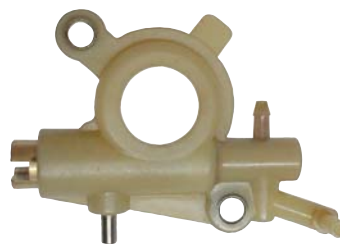

| OEM     |         |
|---------|---------|
| pompa   | vite    |
| 8251590 | 3180310 |

| ARTICOLO     | DESCRIZIONE                      | APPLICAZIONI               |
|--------------|----------------------------------|----------------------------|
| <b>13064</b> | Kit pompa olio + vite senza fine | ALPINA 400-450-460-500-510 |

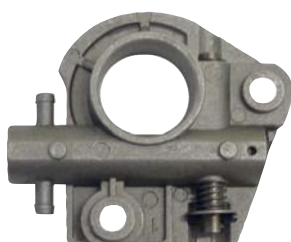

**13065**



| OEM          |            |
|--------------|------------|
| pompa        | vite       |
| 437002-39130 | V652000021 |

| ARTICOLO     | DESCRIZIONE     | APPLICAZIONI  |
|--------------|-----------------|---|
| <b>13065</b> | Pompa olio      | ECHO CS440 - 3000 - 3050 - 3400 - 3450 - 4200 - 4400 - 4510 |
| <b>12961</b> | Vite senza fine |   |
| <b>13271</b> | Vite senza fine |   |
| <b>12960</b> | Vite senza fine |   |
|              |                 | CS4510  |



| OEM         |      |
|-------------|------|
| pompa       | vite |
| C0220-00053 | -    |

| ARTICOLO     | DESCRIZIONE | APPLICAZIONI          |
|--------------|-------------|-----------------------|
| <b>13294</b> | Pompa olio  | Adattabile ECHO CS600 |



**13066**



**13067**

| OEM        |            |
|------------|------------|
| pompa      | vite       |
| 5035213-01 | 5372078-05 |

| ARTICOLO     | DESCRIZIONE     | APPLICAZIONI                  |
|--------------|-----------------|-------------------------------|
| <b>13066</b> | Pompa olio      | HUSQVARNA 362-365-372-385-390 |
| <b>13067</b> | Vite senza fine |                               |



**13069**



**13070**

| OEM         |             |
|-------------|-------------|
| pompa       | vite        |
| 11376403202 | 11296407102 |

| ARTICOLO     | DESCRIZIONE     | APPLICAZIONI                     |
|--------------|-----------------|----------------------------------|
| <b>13069</b> | Pompa olio      | STIHL MS192T - 193T - 200T - 201 |
| <b>13070</b> | Vite senza fine |                                  |



**13293**



**13295**      **13298**

| OEM         |             |             |
|-------------|-------------|-------------|
| pompa       | vite 13295  | vite 13298  |
| 11296403000 | 11296407100 | 11296407101 |

| ARTICOLO     | DESCRIZIONE     | APPLICAZIONI         |
|--------------|-----------------|----------------------|
| <b>13293</b> | Pompa olio      | STIHL MS200T - MS201 |
| <b>13295</b> | Vite senza fine |                      |
| <b>13298</b> | Vite senza fine |                      |



**13097**



**12966**

| OEM         |      |
|-------------|------|
| pompa       | vite |
| 11436403201 | -    |

| ARTICOLO     | DESCRIZIONE     | APPLICAZIONI    |
|--------------|-----------------|-----------------|
| <b>13097</b> | Pompa olio      | STIHL MS231-251 |
| <b>12966</b> | Vite senza fine |                 |

### segue POMPE OLIO PER MOTOSEGHE

POMPES A HUILE POUR TRONÇONNEUSES - OIL PUMPS FOR MOTOR SAWS - ÖLPUMPEN FÜR MOTORSÄGEN - BOMBAS ACEITE PARA SIERRAS ELÉCTRICAS



**13071**



**12966**

| OEM         |      |
|-------------|------|
| pompa       | vite |
| 11416403203 | -    |



**13059**



**13061**

| OEM      |          |
|----------|----------|
| pompa    | vite     |
| 50060015 | 50070025 |

| ARTICOLO     | DESCRIZIONE     | APPLICAZIONI    |
|--------------|-----------------|-----------------|
| <b>13071</b> | Pompa olio      | STIHL MS271-291 |
| <b>12966</b> | Vite senza fine |                 |

| ARTICOLO     | DESCRIZIONE               | APPLICAZIONI    |
|--------------|---------------------------|-----------------|
| <b>13059</b> | Pompa olio                | OLEOMAC 947-952 |
| <b>13061</b> | Vite senza fine (7 denti) |                 |



| ARTICOLO     | Ø | APPLICAZIONI |
|--------------|---|--------------|
| <b>13072</b> | - | OLEOMAC 460  |



**12947**



**12969**

| ARTICOLO     | DESCRIZIONE     | Ø FORO FRONT. | Ø FORO POST. | APPLICAZIONI   |
|--------------|-----------------|---------------|--------------|--|
| <b>12947</b> | Pompa olio      | 20 mm         | 20 mm        | VALEX CS-35 VIGOR<br>VMS-36 BRITECH CS-39<br>FARMER FA-3601<br>SANDRIGARDEN CS36 |
| <b>12969</b> | Vite senza fine | -             | -            |  |



**12878**



**12879**



**13073**

| OEM POMPA |              |
|-----------|--------------|
| ALPINA    | 383594507/0  |
| HUSQVARNA | 505 05 29-01 |
| EMAK      | 50150207     |
| ZENOAH    | Z848CA00640  |

| OEM VITE 2 DENTI |              |
|------------------|--------------|
| ALPINA           | 323878075/0  |
| HUSQVARNA        | 505 05 29-01 |
| EMAK             | 50160224     |
| ZENOAH           | Z285055121   |



**13074**



**13073**



**13075**

| OEM          |      |
|--------------|------|
| pompa        | vite |
| 521 58 65-01 | -    |

| ARTICOLO     | DESCRIZIONE               | APPLICAZIONI                          |
|--------------|---------------------------|---------------------------------------|
| <b>12878</b> | Pompa olio                | ZENOAH G2500-3300-3500-3800-4000-4500 |
| <b>12879</b> | Vite senza fine (2 denti) | ZENOAH G2500-3300-3500-3800 (nuovo)   |
| <b>13073</b> | Vite senza fine (7 denti) | ZENOAH G4000-4500 (tipo nuovo)        |

| ARTICOLO     | DESCRIZIONE               | APPLICAZIONI                      |
|--------------|---------------------------|-----------------------------------|
| <b>13074</b> | Pompa olio                | ZENOAH 415AVS-455AVS-500AVS-G3700 |
| <b>13073</b> | Vite senza fine (7 denti) | ZENOAH 415AVS-G3700 (tipo nuovo)  |
| <b>13075</b> | Vite senza fine (7 denti) | ZENOAH 455AVS-500AVS (tipo nuovo) |



| ARTICOLO     | APPLICAZIONI   |
|--------------|----------------|
| <b>12956</b> | ZENOAH PSZ2600 |



| ARTICOLO     | DESCRIZIONE     | APPLICAZIONI                 |
|--------------|-----------------|------------------------------|
| <b>12957</b> | Vite senza fine | HUSQVARNA<br>181 - 281 - 288 |



| ARTICOLO     | DESCRIZIONE          | APPLICAZIONI |
|--------------|----------------------|--------------|
| <b>12974</b> | Vite senza fine Z.21 | STIHL 028    |

### FILTRI OLIO CATENA

FILTRE A HUILE POUR CHAINES - OIL FILTERS FOR CHAINS - ROLLENKETTEN-ÖLFILTER - FILTRO ACEITE PARA CADENAS



| OEM          |
|--------------|
| 501 54 41-02 |

| ARTICOLO     | APPLICAZIONE   |
|--------------|--|
| <b>12982</b> | HUSQVARNA 61-246-254-261-268-281-288-362-365-371-372 |



| OEM          |
|--------------|
| 436205-02832 |

| ARTICOLO     | APPLICAZIONE                         |
|--------------|--------------------------------------|
| <b>13076</b> | ECHO CS260-270-280-320-380-2600-2700 |



| ARTICOLO     | APPLICAZIONE       | OEM          |
|--------------|--------------------|--------------|
| <b>13077</b> | HUSQVARNA T425-435 | 505 04 51-01 |
|              | ZENOAH G250-G2500  | Z848C106731  |



| OEM         |
|-------------|
| 11236403800 |

| ARTICOLO     | APPLICAZIONE   |
|--------------|--|
| <b>13078</b> | STIHL 017-MS170-171-018-MS180-181-MS192T-193T-MS200T-201-021-MS210-211-023-MS230-231-024-MS240-241-025-MS250-251-026-MS260-261 |



| OEM         |
|-------------|
| 11176403800 |

| ARTICOLO     | APPLICAZIONE  |
|--------------|---|
| <b>13079</b> | STIHL MS271-291-034-MS340-036-MS360-361-362-044-MS440-441-046-MS460-064-MS640-066-MS660 |

### CILINDRI COMPLETI PER MOTOSEGA

CYLINDRES COMPLETS POUR SCIE A CHAÎNE - CHAINSAWS COMPLETE CYLINDERS - ZYLINDER FUER MOTORSÄGEN - CILINDROS COMPLETOS PARA MOTOSIERRAS

**MADE IN ITALY**

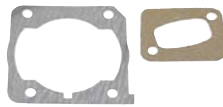

|                 |            |
|-----------------|------------|
| KIT GUARNIZIONI |            |
| <b>13001</b>    |            |
| OEM             |            |
| cilindro        | scarico    |
| 5038944-01      | 5038625-01 |

| ARTICOLO     | ∅     | APPLICAZIONI   | OEM          |
|--------------|-------|--|--------------|
| <b>12931</b> | 45 mm | HUSQVARNA 346XP(big bore) - 350 (big bore) - 350 old model - 351 - 353 JONSERED 2149 - 2150 - 2152 | 503 86 99-71 |

**MADE IN ITALY**



|                 |            |
|-----------------|------------|
| KIT GUARNIZIONI |            |
| <b>13002</b>    |            |
| OEM             |            |
| cilindro        | scarico    |
| 5015122-04      | 5034054-01 |
| aspirazione     |            |
| 5012510-02      |            |

| ARTICOLO     | ∅     | APPLICAZIONI                | OEM          |
|--------------|-------|-----------------------------|--------------|
| <b>12932</b> | 45 mm | HUSQVARNA 154 - 254 - 254XP | 503 44 13-01 |

**MADE IN ITALY**



|                 |            |
|-----------------|------------|
| KIT GUARNIZIONI |            |
| <b>13003</b>    |            |
| OEM             |            |
| cilindro        | scarico    |
| 5031621-03      | 5031023-03 |

| ARTICOLO     | ∅     | APPLICAZIONI | OEM          |
|--------------|-------|--------------|--------------|
| <b>12933</b> | 46 mm | HUSQVARNA 55 | 503 60 91-71 |

**MADE IN ITALY**



|                 |            |
|-----------------|------------|
| KIT GUARNIZIONI |            |
| <b>13004</b>    |            |
| OEM             |            |
| cilindro        | scarico    |
| 5039666-01      | 5039166-01 |

| ARTICOLO     | ∅     | APPLICAZIONI     | OEM          |
|--------------|-------|------------------|--------------|
| <b>12934</b> | 46 mm | HUSQVARNA 357 XP | 537 24 85-02 |

**MADE IN ITALY**



|                 |            |
|-----------------|------------|
| KIT GUARNIZIONI |            |
| <b>13004</b>    |            |
| OEM             |            |
| cilindro        | scarico    |
| 5039666-01      | 5039166-01 |

| ARTICOLO     | ∅     | APPLICAZIONI  | OEM          |
|--------------|-------|---------------|--------------|
| <b>12935</b> | 47 mm | HUSQVARNA 359 | 537 15 73-02 |

**MADE IN ITALY**



|                 |            |
|-----------------|------------|
| KIT GUARNIZIONI |            |
| <b>13006</b>    |            |
| OEM             |            |
| cilindro        | scarico    |
| 5015122-04      | 5034054-01 |
| aspirazione     |            |
| 5018068-03      |            |

| ARTICOLO     | ∅     | APPLICAZIONI                                   | OEM          |
|--------------|-------|--|--------------|
| <b>12936</b> | 52 mm | HUSQVARNA 268 - 268S - 268k-272 - 272XP - 272K | 503 75 81-71 |

**MADE IN ITALY**



|                 |             |
|-----------------|-------------|
| KIT GUARNIZIONI |             |
| <b>13007</b>    |             |
| OEM             |             |
| aspirazione     | scarico     |
| 11231290900     | 11231490500 |

| ARTICOLO     | ∅     | APPLICAZIONI                                  | OEM           |
|--------------|-------|---|---------------|
| <b>12937</b> | 40 mm | STIHL 021 - MS210 - 023 - MS230 - 025 - MS250 | 1123 020 1128 |

**MADE IN ITALY**



|                 |             |
|-----------------|-------------|
| KIT GUARNIZIONI |             |
| <b>13008</b>    |             |
| OEM             |             |
| aspirazione     | scarico     |
| 11290292303     | 11291490600 |

| ARTICOLO     | ∅     | APPLICAZIONI | OEM           |
|--------------|-------|--------------|---------------|
| <b>12938</b> | 40 mm | STIHL MS200T | 1129 020 1202 |

### segue CILINDRI COMPLETI PER MOTOSEGA

CYLINDRES COMPLETS POUR SCIE A CHAÎNE - CHAINSAWS COMPLETE CYLINDERS - ZYLINDER FUER MOTORSÄGEN - CILINDROS COMPLETOS PARA MOTOSIERRAS

**MADE IN ITALY**



**KIT GUARNIZIONI**  
**13009**

OEM  
11450292302

| ARTICOLO     | ∅     | APPLICAZIONI | OEM           |
|--------------|-------|--------------|---------------|
| <b>12939</b> | 40 mm | STIHL MS201  | 1145 020 1200 |

**MADE IN ITALY**



**KIT GUARNIZIONI**  
**13010**

OEM

|             |             |
|-------------|-------------|
| cilindro    | scarico     |
| 11180292306 | 11181490600 |

| ARTICOLO     | ∅     | APPLICAZIONI | OEM           |
|--------------|-------|--------------|---------------|
| <b>12940</b> | 42 mm | STIHL 024    | 1121 020 1200 |

**MADE IN ITALY**



**KIT GUARNIZIONI**  
**13011**

OEM

|             |             |
|-------------|-------------|
| cilindro    | scarico     |
| 11210292305 | 11181490600 |

| ARTICOLO     | ∅     | APPLICAZIONI      | OEM           |
|--------------|-------|-------------------|---------------|
| <b>12941</b> | 44 mm | STIHL 026 - MS260 | 1121 020 1203 |

**MADE IN ITALY**



**KIT GUARNIZIONI**  
**13012**

OEM

|             |             |
|-------------|-------------|
| cilindro    | scarico     |
| 11250291301 | 11251490601 |

| ARTICOLO     | ∅     | APPLICAZIONI            | OEM           |
|--------------|-------|-------------------------|---------------|
| <b>12942</b> | 48 mm | STIHL 034 - 036 - MS360 | 1125 020 1215 |

**MADE IN ITALY**



**KIT GUARNIZIONI**  
**13013**

OEM

|             |             |
|-------------|-------------|
| cilindro    | scarico     |
| 11280292302 | 11251490601 |

| ARTICOLO     | ∅     | APPLICAZIONI      | OEM           |
|--------------|-------|-------------------|---------------|
| <b>12943</b> | 50 mm | STIHL 044 - MS440 | 1127 020 1210 |

### DECOMPRESSORI PER MOTOSEGA

DÉCOMPRESSEURS POUR SCIE A CHAÎNE - CHAINSAWS DECOMPRESSORS - DECOMPRESSOREN FUER MOTORSÄGEN - DECOMPRESORES PARA MOTOSIERRAS



| ARTICOLO     | APPLICAZIONI | OEM          |
|--------------|--------------|--------------|
| <b>12983</b> | HUSQVARNA    | 503 71 53-01 |



| ARTICOLO     | APPLICAZIONI | OEM           |
|--------------|--------------|---------------|
| <b>12984</b> | STIHL        | 1128 020 9400 |

### AVVIAMENTI COMPLETI PER DECESPUGLIATORI

DEMARREUR POUR DÉBROUSSAILLEUSE - STARTER FOR BRUSH-CUTTER - ANLASSEN FÜR MULCHER - ARRANCADOR PARA DESBROZADORA



| ARTICOLO     | APPLICAZIONI      | OEM             |
|--------------|-------------------|-----------------|
| <b>13080</b> | HONDA GX22 - GX31 | 28400-ZM2-003ZA |



| ARTICOLO     | APPLICAZIONI | OEM           |
|--------------|--------------|---------------|
| <b>13081</b> | HONDA GX25   | 28400-Z0H-003 |



| ARTICOLO     | APPLICAZIONI | OEM           |
|--------------|--------------|---------------|
| <b>13082</b> | HONDA GX35   | 28400-Z0Z-003 |



| ARTICOLO     | APPLICAZIONI         | OEM        |
|--------------|----------------------|------------|
| <b>13083</b> | KAWASAKI TD40 - TD48 | 49088.2166 |



| ARTICOLO     | APPLICAZIONI  | OEM        |
|--------------|---------------|------------|
| <b>13084</b> | KAWASAKI TH23 | 49088-2532 |



| ARTICOLO     | APPLICAZIONI         | OEM        |
|--------------|----------------------|------------|
| <b>13085</b> | KAWASAKI TH43 - TH48 | 49088-2442 |



| ARTICOLO     | APPLICAZIONI                  | OEM       |
|--------------|-------------------------------|-----------|
| <b>13086</b> | MITSUBISHI TL23 - TL26 - TU26 | KS20054AA |



| ARTICOLO     | APPLICAZIONI                  | OEM      |
|--------------|-------------------------------|----------|
| <b>13087</b> | MITSUBISHI TL33 - TL43 - TL52 | K20037AA |



### segue AVVIAMENTI COMPLETI PER DECESPUGLIATORI

DEMARREUR POUR DÉBROUSSAILLEUSE - STARTER FOR BRUSH-CUTTER - ANLASSEN FÜR MULCHER - ARRANCADOR PARA DESBROZADORA



| ARTICOLO     | APPLICAZIONI                  | OEM       |
|--------------|-------------------------------|-----------|
| <b>13088</b> | MITSUBISHI TL33 - TL43 - TL52 | KS02079AA |



| ARTICOLO     | APPLICAZIONI           | OEM |
|--------------|------------------------|-----|
| <b>13089</b> | TANAKA TAS321 - TAS328 | -   |



| ARTICOLO     | APPLICAZIONI                  | OEM                        |
|--------------|-------------------------------|----------------------------|
| <b>13090</b> | HUSQVARNA 143R<br>ZENOAH G45L | 505 30 17-01<br>Z450075100 |



| ARTICOLO     | APPLICAZIONI | OEM        |
|--------------|--------------|------------|
| <b>13091</b> | ZENOAH G4K   | Z148775100 |



| ARTICOLO     | APPLICAZIONI | OEM |
|--------------|--------------|-----|
| <b>13092</b> | ZENOAH G23L  | -   |



| ARTICOLO     | APPLICAZIONI | OEM        |
|--------------|--------------|------------|
| <b>13093</b> | ZENOAH G2K   | Z550075100 |

### BOBINA CORDA AVVIAMENTO

BOBINES CORDE DEMARRAGE  
STARTING CORD COILS  
ANLAUF SCHNUR SPULEN  
BOBINA CUERDA ARRANQUE



| ARTICOLO     | DESCRIZIONE                      | NOTE   |
|--------------|----------------------------------|--|
| <b>12028</b> | Bobina corda avviamento Ø 3 mm   | Ogni bobina<br>contiene<br>100 m<br>di corda |
| <b>12029</b> | Bobina corda avviamento Ø 3,5 mm |  |
| <b>12030</b> | Bobina corda avviamento Ø 4 mm   |  |
| <b>12031</b> | Bobina corda avviamento Ø 4,5 mm |  |

16

### CARBURATORE UNIVERSALE PER DECESPUGLIATORI CON MOTORE FINO A 33CC

CARBURATEUR UNIVERSEL POUR DÉBROUSSAILLEUSES AVEC MOTEUR JUSQU'À 33 CC  
 UNIVERSAL CARBURETTOR FOR BRUSH CUTTERS WITH UP TO 33 CC ENGINE  
 UNIVERSALVERGASER FÜR FREISCHNEIDER MIT MOTOREN BIS 33 CC<sup>3</sup>  
 CARBURADOR UNIVERSAL PARA DESBROZADORAS CON MOTOR HASTA 33 CC

new



#### CARATTERISTICHE

Carburatore specifico per decespugliatori vari modelli adattabile anche a molti modelli di importazione commercializzati con marchi diversi. Grazie alla vite di regolazione è possibile, entro certi limiti, adattare la carburazione su motori diversi.

Adattabile a Walbro WYJ.

| ARTICOLO     | PER MOTORI   | Ø FORI mm | Ø ASPIRAZIONE mm | INTERASSE FORI mm | APPLICAZIONI    | OEM     |
|--------------|--------------|-----------|------------------|-------------------|-----------------|---------|
| <b>13296</b> | Fino a 33 cc | 5,5       | 11,35            | 31                | CG330<br>WALBRO | WYJ 192 |

### CARBURATORE UNIVERSALE PER DECESPUGLIATORI CON MOTORE FINO A 43CC

CARBURATEUR UNIVERSEL POUR DÉBROUSSAILLEUSES AVEC MOTEUR JUSQU'À 43 CC  
 UNIVERSAL CARBURETTOR FOR BRUSH CUTTERS WITH UP TO 43 CC ENGINE  
 UNIVERSALVERGASER FÜR FREISCHNEIDER MIT MOTOREN BIS 43 CC<sup>3</sup>  
 CARBURADOR UNIVERSAL PARA DESBROZADORAS CON MOTOR HASTA 43 CC

new



#### CARATTERISTICHE

Carburatore specifico per decespugliatori vari modelli adattabile anche a molti modelli di importazione commercializzati con marchi diversi. Grazie alla vite di regolazione è possibile, entro certi limiti, adattare la carburazione su motori diversi.

Adattabile a Walbro WYJ.

| ARTICOLO     | PER MOTORI          | Ø FORI mm | Ø ASPIRAZIONE mm | INTERASSE FORI mm | APPLICAZIONI    | OEM     |
|--------------|---------------------|-----------|------------------|-------------------|-----------------|---------|
| <b>13297</b> | da 34 cc<br>a 43 cc | 5,5       | 12,5             | 31                | CG430<br>WALBRO | WYK 352 |

### CARBURATORE DECESPUGLIATORE

CARBURATEUR DÉBROUSSAILLEUSE  
 BRUSH CUTTER CARBURETTOR  
 VERGASER FÜR FREISCHNEIDER  
 CARBURADOR DESBROZADORA

new

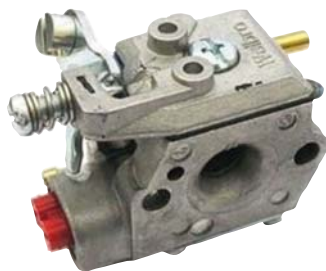

| ARTICOLO     | APPLICAZIONI                                     | OEM               |
|--------------|--|-------------------|
| <b>13382</b> | OLEO-MAC SPARTA 37 – SPARTA 42<br>WALBRO<br>EMAK | WT 869<br>2318765 |

### CARBURATORE DECESPUGLIATORE

CARBURATEUR DÉBROUSSAILLEUSE  
 BRUSH CUTTER CARBURETTOR  
 VERGASER FÜR FREISCHNEIDER  
 CARBURADOR DESBROZADORA

new



| ARTICOLO     | APPLICAZIONI  | OEM                 |
|--------------|---|---------------------|
| <b>13384</b> | OLEO-MAC SPARTA 40 – 443 – 435 – 440 –<br>727 – 730 – 733 – 735 - 740<br>WALBRO<br>EMAK | WT 442E<br>2318690R |

**CARBURATORE MOTOSEGA**

CARBURATEUR SCIE À MOTEUR  
CHAINSAW CARBURETTOR  
VERGASER FÜR MOTORSÄGE  
CARBURADOR SIERRA ELÉCTRICA

new



| ARTICOLO     | APPLICAZIONI           | OEM    |
|--------------|------------------------|--------|
| <b>13381</b> | WALBRO<br>ZENOAH G2500 | WT 596 |

**CARBURATORE MOTOSEGA**

CARBURATEUR SCIE À MOTEUR  
CHAINSAW CARBURETTOR  
VERGASER FÜR MOTORSÄGE  
CARBURADOR SIERRA ELÉCTRICA

new



| ARTICOLO     | APPLICAZIONI                         | OEM                   |
|--------------|--------------------------------------|-----------------------|
| <b>13383</b> | OLEO-MAC 947 - 952<br>WALBRO<br>EMAK | HDA 205E<br>50070224B |

**CARBURATORE MOTOSEGA**

CARBURATEUR SCIE À MOTEUR  
CHAINSAW CARBURETTOR  
VERGASER FÜR MOTORSÄGE  
CARBURADOR SIERRA ELÉCTRICA

new



| ARTICOLO     | APPLICAZIONI                                  | OEM                |
|--------------|---|--------------------|
| <b>13385</b> | OLEO-MAC 937 - 941C - 941CX<br>WALBRO<br>EMAK | WT 780D<br>2318755 |

**POMPA BENZINA PER RASAERBA**

POMPE ESSENCE POUR TONDEUSE À GAZON  
FUEL PUMP FOR LAWN MOWER  
BENZINPUMPE FÜR RASENMÄHER  
BOMBA GASOLINA PARA CORTACÉSPED

new



| ARTICOLO     | APPLICAZIONI                         | OEM   |
|--------------|--------------------------------------|---|
| <b>13380</b> | BRIGGS&STRATTON<br>HONDA<br>KAWASAKI | 491922 - 808656<br>16700-Z0J-003<br>KS490407001 |

16

### TUBO PER MISCELA (NERO)

TUYAU POUR MELANGE (noir)  
FUEL MIXTURE HOSE (black)  
LEITUNG FÜR GEMISCH (schwarz)  
TUBO PARA MEZCLA (negro)



| ARTICOLO     | DIMENSIONI mm | NOTE       | CARATTERISTICHE |
|--------------|---------------|------------|-----------------|
| <b>12439</b> | 3,0x5,6       | Calibrato  | Rotoli da 5 m   |
| <b>13014</b> | 3,2x6,0       | Universale |                 |
| <b>13063</b> | 6,0x8,5       | -          |                 |

### TUBO PER MISCELA (GIALLO TRASPARENTE)

TUYAU POUR MELANGE (jaune transparent)  
FUEL MIXTURE HOSE (transparent yellow)  
LEITUNG FÜR GEMISCH (gelb transparent)  
TUBO PARA MEZCLA (amarillo transparente)



Costituito con una speciale miscela vinilica è idoneo per qualsiasi tipo di benzina o lubrificante. La sua specifica composizione lo rende particolarmente resistente all'invecchiamento, limitandone la sua tendenza all'indurimento e alla formazione di crepe o deformazioni. Il colore giallo trasparente consente di verificare facilmente il flusso dei liquidi in transito.

| ARTICOLO     | DIMENSIONI mm | CARATTERISTICHE |
|--------------|---------------|-----------------|
| <b>12322</b> | 2,4x4,8       | Rotoli da 5 m   |
| <b>13291</b> | 3,2x5,3       |                 |
| <b>12323</b> | 3,2x6,4       |                 |
| <b>12324</b> | 4,8x8,0       |                 |
| <b>12325</b> | 6,3x9,3       |                 |

### TUBO NERO IN GOMMA NITRILICA ADATTABILE ECHO V471-001260

TUYAU NOIR EN CAOUTCHOUC NITRILE ADAPTABLE ECHO V471-001260  
BLACK NITRILE RUBBER HOSE SUITABLE FOR ECHO V471-001260  
SCHWARZER, ANPASSBARER SCHLAUCH AUS NITRILGUMMI ECHO V471-001260  
TUBO NEGRO DE GOMA NITRILICA ADAPTABLE ECHO V471-001260

new



| ARTICOLO     | DIMENSIONI mm | CARATTERISTICHE |
|--------------|---------------|-----------------|
| <b>13292</b> | 2,4x5,0       | Rotoli da 2 m   |

### PESCAMISCELA

RENIFLARD - FUEL PICK-UP - MISCHUNGSANSAUGER - ASPIRACIÓN MEZCLA



**MADE IN ITALY**

| ARTICOLO     | DIMENSIONI | ATTACCO  | APPLICAZIONE     |
|--------------|------------|----------|------------------|
| <b>12318</b> | 15x26 mm   | Ø 5,7 mm | TILLOTSON OW-497 |



**MADE IN ITALY**

| ARTICOLO     | DIMENSIONI | ATTACCO  | APPLICAZIONE     |
|--------------|------------|----------|------------------|
| <b>12319</b> | 21x29 mm   | Ø 5,7 mm | TILLOTSON OW-802 |



**MADE IN ITALY**

| ARTICOLO     | DIMENSIONI | ATTACCO  | APPLICAZIONE |
|--------------|------------|----------|--------------|
| <b>12158</b> | 21x29 mm   | Ø 6,2 mm | STIHL        |



**MADE IN ITALY**

| ARTICOLO     | DIMENSIONI | ATTACCO  | APPLICAZIONE     |
|--------------|------------|----------|------------------|
| <b>12320</b> | 15x22 mm   | Ø 5,4 mm | WALBRO 125 - 527 |



**MADE IN ITALY**

| ARTICOLO     | DIMENSIONI | ATTACCO  | APPLICAZIONE     |
|--------------|------------|----------|------------------|
| <b>12321</b> | 15x22 mm   | Ø 5,4 mm | WALBRO 125 - 529 |



| ARTICOLO     | DIMENSIONI | ATTACCO  | APPLICAZIONE |
|--------------|------------|----------|--------------|
| <b>12436</b> | 13x21 mm   | Ø 3,2 mm | ZAMA ZF-1    |



**MADE IN ITALY**

### VALVOLA DI SFIATO PER MOTOSEGHE E DESCESPUGIATORI

SOUPAPE D'AÉRATION  
TANK VENT  
ENTLÜFTUNGSVENTIL  
VÁLVULA DE VENTILACIÓN

| ARTICOLO     | DIMENSIONI mm | ATTACCO mm | NOTE   | APPLICAZIONE WALBRO |
|--------------|---------------|------------|--|---------------------|
| <b>12630</b> | 20x29         | Ø 5,4      | Con rete interna SINGOLA<br>Per motori fino a 80cc | 125 - 528           |
| <b>13290</b> | 20x29         | Ø 5,4      | Con rete interna DOPPIA<br>Per motori fino a 125cc | 125 - 532           |



| ARTICOLO     |
|--------------|
| <b>13062</b> |

### RICAMBI ADATTABILI PER MOTORE HONDA GX160

PIECE DETACHEES ADAPTABLES POUR MOTEUR HONDA GX160 - SPARES SUITABLE FOR HONDA GX160 ENGINES  
ANPASSBARE ERSATZTEILE FÜR MOTOR HONDA GX160 - REPUESTOS ADAPTABLES PARA MOTOR HONDA GX160



| ARTICOLO     | DESCRIZIONE | OEM          |
|--------------|-------------|--------------|
| <b>12642</b> | Paraolio    | 91203-ZE0-13 |



| ARTICOLO     | DESCRIZIONE             | OEM           |
|--------------|-------------------------|---------------|
| <b>12649</b> | Distanziale carburatore | 16211-ZE1-000 |



| ARTICOLO     | DESCRIZIONE | OEM           |
|--------------|-------------|---------------|
| <b>12650</b> | Carburatore | 16100-ZH8-020 |



| ARTICOLO     | DESCRIZIONE | OEM |
|--------------|-------------|-----|
| <b>12651</b> | Spia olio   | -   |



| ARTICOLO     | DESCRIZIONE     | OEM           |
|--------------|-----------------|---------------|
| <b>12652</b> | Indicatore olio | 15510-ZE1-033 |



| ARTICOLO     | DESCRIZIONE | OEM                            |
|--------------|-------------|--------------------------------|
| <b>12653</b> | Tappo olio  | 15600-ZE1-003<br>15600-ZG4-003 |



| ARTICOLO     | DESCRIZIONE | OEM           |
|--------------|-------------|---------------|
| <b>12655</b> | Comando     | 16500-ZH8-822 |



| ARTICOLO     | DESCRIZIONE | OEM           |
|--------------|-------------|---------------|
| <b>12656</b> | Regolatore  | 16561-ZE1-020 |



| ARTICOLO     | DESCRIZIONE          | OEM             |
|--------------|----------------------|-----------------|
| <b>12657</b> | Serbatoio carburante | 17510-ZE1-020ZA |



| ARTICOLO     | DESCRIZIONE | OEM           |
|--------------|-------------|---------------|
| <b>12658</b> | Motorstop   | 36100-ZE1-015 |



| ARTICOLO     | DESCRIZIONE | OEM           |
|--------------|-------------|---------------|
| <b>12659</b> | Bobina      | 30500-ZE1-033 |



| ARTICOLO     | DESCRIZIONE         | OEM             |
|--------------|---------------------|-----------------|
| <b>12660</b> | Avviamento autoavv. | 28400-ZE1-003ZA |



| ARTICOLO     | DESCRIZIONE              | OEM             |
|--------------|--------------------------|-----------------|
| <b>12661</b> | Tappo carburante cromato | 17510-ZE1-020ZA |



| ARTICOLO     | DESCRIZIONE           | OEM |
|--------------|-----------------------|-----|
| <b>12662</b> | Tappo carburante nero | -   |



| ARTICOLO     | DESCRIZIONE            | OEM           |
|--------------|------------------------|---------------|
| <b>12832</b> | Kit guarnizione motore | 061A1-ZF1-000 |

### CANDELE NGK - DENSO

BOUGIES - PLUGS - KERZEN - BUJIAS



| CANDELE                 |                            | DATI TECNICI  | APPLICAZIONI   |
|-------------------------|----------------------------|---|--|
| ORIGINALI NGK           | ORIGINALI DENSO            |   |  |
| <b>11498</b><br>B6HS    | <b>13225</b><br>W20FP-U    | Filetto=M14<br>Lungh. Filetto=13 mm<br>(normale)<br>Esagono=21 mm | ACME-BETA-CM-COTIEMME-DUCATI-INTERMOTOR-JLO-LOMBARDINI-MINARELLI-VOLPI-ZANETTI |
| <b>10568</b><br>AB6     | <b>13215</b><br>MW17       | Filetto=M18<br>Lungh. Filetto=12 mm<br>(normale)<br>Esagono=21 mm | ACME-COTIEMME-DUCATI-GUIDETTI-LOMBARDINI-VOLPI                                 |
| <b>12181</b><br>BKR 5ES | <b>13232</b><br>K16PR-U    | Filetto=M14<br>Lungh. Filetto=19 mm<br>(lunga)<br>Esagono=16 mm   | BRIGGS&STRATTON-MOTORI BICILINDRICI MODELLO VANGUARD OEM: 491055               |
| <b>12625</b><br>BCP6ES  | <b>13236</b><br>Q20R-U     | Filetto=M14<br>Lungh. Filetto=19 mm<br>(lunga)<br>Esagono=16 mm   | BRIGGS&STRATTON serie VANGUARD   |
| <b>12599</b><br>BR7ES   | <b>13235</b><br>W22ESR-U   | Filetto=M14<br>Lungh. Filetto=19 mm<br>(lunga)<br>Esagono=21 mm   | TECUMSEH: GEOTEC 45-50-55-60-65 OHV4takt ENDURO OHV4takt FORMULA OHV4takt      |
| <b>11494</b><br>BPR4HS  | <b>13222</b><br>W14FRPR-UL | Filetto=M14<br>Lungh. Filetto=13 mm<br>(normale)<br>Esagono=21 mm | HONDA - KAWASAKY - ROBIN - YANMAR  |
| <b>11492</b><br>BR6HS   | <b>13221</b><br>WF20TT     | Filetto=M14<br>Lungh. Filetto=13 mm<br>(normale)<br>Esagono=21 mm | AGRIA - HONDA - KAWASAKY - ROBIN - SABO  |
| <b>10054</b><br>BP5HS   |                            | Filetto=M14<br>Lungh. Filetto=13 mm<br>(normale)<br>Esagono=21 mm | HONDA - INTERMOTOR (LOMBARDINI) - KAWASAKI - KUBOTA                            |

| CANDELE              |                         | DATI TECNICI  | APPLICAZIONI  |
|----------------------|-------------------------|---|---|
| ORIGINALI NGK        | ORIGINALI DENSO         |   |   |
| <b>11498</b><br>B6HS | <b>13225</b><br>W20FP-U | Filetto=M14<br>Lungh. Filetto=13 mm<br>(normale) - Esagono=21 | JO.BU-JONSERED-Mc CULLOCH-LANDONI-PARTNER-SOLO-STIHL              |
| <b>10564</b><br>B6S  | <b>13211</b><br>W20S-U  | Filetto=M14<br>Lungh. Filetto=9,5 mm<br>(corto) - Esagono=21  | ALPINA-HOMELITE-LOMARD-Mc CULLOCH-PIONEER-POULAN-REMINGTON-TANAKA |
| <b>11488</b><br>BM6F | <b>13217</b><br>T20M-U  | Filetto=M14<br>Lungh. Filetto=8 mm<br>(corto) - Esagono=16    | HOMELITE-HUSQVARNA-LANDONI-LOMBARD-Mc CULLOCH-PARTNER-SKIL        |

| CANDELE                                |                            | DATI TECNICI   | APPLICAZIONI   |
|--|----------------------------|--|--|
| ORIGINALI NGK                          | ORIGINALI DENSO            |  |  |
| <b>10566</b><br>BM6A                   | <b>13213</b><br>W20MR-U    | Filetto=M14<br>Lungh. Filetto=9,5 mm<br>(corto)<br>Esagono=19 mm | ALPINA-COMER-DANARM-DOLMAR-ECHO-KIORITZ-HOMELITE-HUSQVARNA-JO.BU-JONSERED-LANDONI-LOMBARD-OLEO.MAC-OPEM-PARTNER-PIONEER-POULAN-QUADRA-REMINGTON-SHINDAIWA-SKIL-SOLO-STIHL-TAS-TANAKA |
| <b>11342</b><br>BMR6A<br>ANTIDISTURBO  | <b>13213</b><br>W20MR-U    |  |  |
| <b>10565</b><br>BM7A<br>FREDDA         | <b>13212</b><br>W22M-U     |  |  |
| <b>12176</b><br>BMR7A<br>ANTIDISTURBO  | <b>13212</b><br>W22M-U     |  |  |
| <b>10562</b><br>BPM6A                  | <b>13209</b><br>W20MP-U    | Filetto=M14<br>Lungh. Filetto=9,5 mm<br>(corto)<br>Esagono=19 mm | ALPINA-BLITZ-DOLMAR-ECHO-HOMELITE-HUSQVARNA-JO.BU-JONSEREDS-LANDONI-LOMBARD-MONDIAL-OLEO.MAC-OPEM-PARTNER-PIONEER-POULAN-REMINGTON-SHINDAIWA-SKIL-SOLO-STIHL-TAS.TANAKA-TOPSO        |
| <b>11490</b><br>BPMR6A<br>ANTIDISTURBO | <b>13219</b><br>W20MPR-U10 |  |  |
| <b>11489</b><br>BPM7A<br>FREDDA        | <b>13218</b><br>W22MP-U    |  |  |
| <b>12177</b><br>BPMR7A<br>ANTIDISTURBO | <b>13228</b><br>W22MPR-U   |  |  |
| <b>12627</b><br>CMR7H                  |                            | Filetto=M10<br>Lungh. Filetto=12,7mm<br>Esagono=16 mm            | TANAKA RYOBI   |
| <b>11497</b><br>BL6H                   |                            | Filetto=M14<br>Lungh. Filetto=13mm<br>Esagono=21 mm              | DOLMAR   |

| CANDELE                                |                          | DATI TECNICI  | APPLICAZIONI  |
|--|--------------------------|---|---|
| ORIGINALI NGK                          | ORIGINALI DENSO          |   |   |
| <b>10564</b><br>B6S                    | <b>13211</b><br>W20S-U   | Filetto=M14<br>Lungh. Filetto=9,5 mm<br>(corto)<br>Esagono=21 mm  | Mc CULLOCH-ZENOAH   |
| <b>11498</b><br>B6HS                   | <b>13225</b><br>W20FP-U  | Filetto=M14<br>Lungh. Filetto=13 mm<br>(normale)<br>Esagono=21 mm | JONSERED-Mc CULLOCH   |
| <b>12177</b><br>BPMR7A<br>ANTIDISTURBO | <b>13228</b><br>W22MPR-U | Filetto=M14<br>Lungh. Filetto=9,5 mm<br>(corto)<br>Esagono=19 mm  | ALPINA-DOLMAR-HUSQVARNA-JONSERED-NAUTAC-OLEO.MAC-PARTNER-SOLO-STIHL |
| <b>10566</b><br>BM6A                   | <b>13213</b><br>W20MR-U  | Filetto=M14<br>Lungh. Filetto=9,5 mm<br>(corto)<br>Esagono=19 mm  | HOMELITE-HUSQVARNA-JONSERED-SHINDAIWA-SOLO-TANAKA-ZENOAH            |
| <b>11488</b><br>BM6F                   | <b>13217</b><br>T20M-U   | Filetto=M14<br>Lungh. Filetto=8 mm<br>(corto)<br>Esagono=16 mm    | HOMELITE-SOLO   |
| <b>10565</b><br>BM7A<br>FREDDA         | <b>13212</b><br>W22M-U   | Filetto=M14<br>Lungh. Filetto=9,5mm<br>(corto)<br>Esagono=19 mm   | ALPINA-MAKITA-Mc CULLOCH-TANAKA-ZENOAH                              |
| <b>10562</b><br>BPM6A                  | <b>13209</b><br>W20MP-U  | Filetto=M14<br>Lungh. Filetto=9,5mm<br>(corto)<br>Esagono=19 mm   | HUSQVARNA-TANAKA  |

### segue CANDELE NGK - DENSO

BOUGIES - PLUGS - KERZEN - BUJIAS

| CANDELE                               |                          | DATI TECNICI  | APPLICAZIONI  |
|---------------------------------------|--------------------------|---|---|
| ORIGINALI NGK                         | ORIGINALI DENSO          |   |   |
| <b>11489</b><br>BPM7A<br>FREDDA       | <b>13218</b><br>W22MP-U  | Filetto=M14<br>Lungh. Filetto=9,5mm<br>(corto) - Esagono=19     | ECHO-EFCO-HOMELITE-<br>MAKITA   |
| <b>11342</b><br>BMR6A<br>ANTIDISTURBO | <b>13213</b><br>W20MR-U  | Filetto=M14<br>Lungh. Filetto=9,5mm<br>(corto)<br>Esagono=19 mm | ECHO-FLYMO-<br>HUSQVARNA-Mc<br>CULLOCH-MOUNTFIELD-<br>PARTNER-SHINDAIWA-<br>STIHL-WOLF<br>HONDA 4 TEMPI |
| <b>12466</b><br>CMR5H                 | —                        | Filetto=M10<br>Lungh. Filetto=12,7mm<br>Esagono=16 mm           | DOLMAR  |
| <b>12468</b><br>CMR6A                 | —                        | Filetto=M14<br>Lungh. Filetto=8mm<br>Esagono=16 mm              | HONDA   |
| <b>12476</b><br>BPR6ES                | <b>13234</b><br>W20EPR-U | Filetto=M14<br>Lungh. Filetto=19mm<br>Esagono=21 mm             | HONDA 4 TEMPI<br>HONDA-STIHL  |
| <b>12627</b><br>CMR7H                 | —                        | Filetto=M10<br>Lungh. Filetto=12,7mm<br>Esagono=16 mm           | STIHL   |
| <b>12828</b><br>CMR6H                 | —                        | Filetto=M10<br>Lungh. Filetto=12,7mm<br>Esagono=16 mm           | RYOBI   |
| <b>12829</b><br>CMR7A                 | —                        | Filetto=M10<br>Lungh. Filetto=9,5mm<br>Esagono=16 mm            |   |

| CANDELE               |                         | DATI TECNICI   | APPLICAZIONI  |
|-----------------------|-------------------------|--|---|
| ORIGINALI NGK         | ORIGINALI DENSO         |  |   |
| <b>12626</b><br>B-4H  | <b>13237</b><br>W14F-U  | Filetto=M14<br>Lungh. Filetto=9,5 mm<br>(corto) - Esagono=21     | AGRIA-FICHTEL&SACHS-<br>HAKO-HOLDER-KYNAST-<br>SABO   |
| <b>11496</b><br>B4-LM | <b>13224</b><br>W14LM-U | Filetto=M14<br>Lungh. Filetto=9,5 mm<br>(corto)<br>Esagono=21 mm | AGRIA-ALKO-ALPINA-<br>ASPERA-BARRUS-<br>BOLENS-BRIGGS &<br>S.-BRILL-CONCORD-<br>CRESCENT-CROWN-ERING-<br>FLANDRIA-FLYMO-GOLF-<br>GUTBROD-HAKO-HARRY-<br>HERKULES-HOLDER-<br>HUSQVARNA-JACOBSEN-<br>KYNAST-LEOPARD-<br>MOMARK-NORLETT-QUEEN<br>GARDEN-SOLO-TORO-<br>WOLF |
| <b>10567</b><br>B5HS  | <b>13214</b><br>W16FS-U | Filetto=M14<br>Lungh. Filetto=13 mm<br>(normale) - Esagono=21    | BRILL-FICHTEL-GUTBROD-<br>HAKO-HARRY-HOLDER-<br>SABO-SOLO-WOLF  |
| <b>11498</b><br>B6HS  | <b>13225</b><br>W20FP-U | Filetto=M14<br>Lungh. Filetto=13 mm<br>(normale) Esagono=21      | AGRIA-AS MOTOR-FLYMO-<br>HAKO-JLO-JACOBSEN-<br>ROBIN-SOLO-TECUMSEH-<br>WOLF-ZENOAH  |
| <b>10564</b><br>B6S   | <b>13211</b><br>W20S-U  | Filetto=M14<br>Lungh. Filetto=9,5 mm<br>(corto) - Esagono=21     | BRIGGS & STRATTON-<br>BOLENS-CRESCENT-HAKO-<br>JACOBSEN-MONARK-<br>MOUNTFIELD-STIHL   |

| CANDELE                               |                            | DATI TECNICI   | APPLICAZIONI   |
|---------------------------------------|----------------------------|--|--|
| ORIGINALI NGK                         | ORIGINALI DENSO            |  |  |
| <b>11502</b><br>B7HS                  | <b>13226</b><br>W22FS-U    | Filetto=M14<br>Lungh. Filetto=13 mm<br>(normale) - Esagono=21    | AGRIA-FICHTEL & SACHS-<br>FLYMO-IRUS-ROBIN-<br>YAMAHA  |
| <b>12175</b><br>BCPR5ES               | <b>13227</b><br>Q16PR-U    | Filetto=M14<br>Lungh. Filetto=19 mm<br>(lunga) - Esagono=16      | BRIGGS & STRATTON-<br>GUTBROD-HARRY-<br>KOHLER-PHONIX-SOLO-<br>VIKING-YAMAHA   |
| <b>10566</b><br>BM6A                  | <b>13213</b><br>W20MR-U    | Filetto=M14<br>Lungh. Filetto=9,5 mm<br>(corto)<br>Esagono=19 mm | FLYMO-GUTBROD-HAKO-<br>HARRY-HARKULES-<br>HUSQVARNA-LAWNBOY-<br>ROBIN-STARK-STIHL-<br>TORO-WOLF-ZENOAH                     |
| <b>10565</b><br>BM7A<br>FREDDA        | <b>13212</b><br>W22M-U     | Filetto=M14<br>Lungh. Filetto=9,5 mm<br>(corto) - Esagono=19     | ROBIN-SOLO-ZENOAH  |
| <b>11342</b><br>BMR6A<br>ANTIDISTURBO | <b>13213</b><br>W20MR-U    | Filetto=M14<br>Lungh. Filetto=9,5 mm<br>(corto) - Esagono=19     | ALLEN-FLYMO-HONDA-<br>HUSQVARNA-KOHLER-<br>SABO-SOLO-TORO-WOLF-<br>ZENOAH  |
| <b>10053</b><br>BP5ES                 | <b>13208</b><br>W16EP-U    | Filetto=M14<br>Lungh. Filetto=19 mm<br>(lunga) - Esagono=21      | HONDA-SOLO   |
| <b>11491</b><br>BP6ES                 | <b>13220</b><br>W20EP-U    | Filetto=M14<br>Lungh. Filetto=19 mm<br>(lunga) - Esagono=21      | HERCULES-ROBIN   |
| <b>10563</b><br>BP6HS                 | <b>13225</b><br>W20FP-U    | Filetto=M14<br>Lungh. Filetto=13 mm<br>(normale) - Esagono=21    | AGRIA-HAKO-PARTNER-<br>ROBIN-YAMAHA  |
| <b>11495</b><br>BPR5ES                | <b>13223</b><br>W16EPR-U   | Filetto=M14<br>Lungh. Filetto=19 mm<br>(lunga) - Esagono=21      | BRILL-HONDA-<br>HUSQVARNA-PHONIX-<br>SABO-SOLO-YAMAHA  |
| <b>12180</b><br>BR2-LM                | <b>13231</b><br>W9LMR-US   | Filetto=M14<br>Lungh. Filetto=9,5 mm<br>(corto)<br>Esagono=19 mm | BRIGGS & STRATTON-<br>ECHO-EFCO-GUTBROD-<br>HARRY-HERKULES-<br>PARTNER-PHONIX-SABO-<br>SOLO-TECNAMOTOR-<br>TECUMSEH-VIKING |
| <b>12179</b><br>BR4-LM                | <b>13230</b><br>W14LM-U    | Filetto=M14<br>Lungh. Filetto=9,5 mm<br>(corto) - Esagono=19     | ASPERA-GOLF-GUTBROD-<br>HUSQVARNA-PARTNER-<br>TECNAMOTOR-TECUMSEH  |
| <b>11085</b><br>BR4HS                 | <b>13216</b><br>W14FR-U    | Filetto=M14<br>Lungh. Filetto=13 mm<br>(normale) - Esagono=21    | HONDA-YANMAR   |
| <b>12178</b><br>BR6ES                 | <b>13229</b><br>W20ESR-U   | Filetto=M14<br>Lungh. Filetto=19 mm<br>(lunga) - Esagono=21      | BRIGGS&STRATTON-SABO-<br>SOLO-TORO-ZENOAH  |
| <b>11494</b><br>BPR4HS                | <b>13222</b><br>W14FRPR-UL | Filetto=M14<br>Lungh. Filetto=13 mm<br>(normale) - Esagono=21    | HONDA - KAWASAKY -<br>ROBIN - YANMAR   |
| <b>11492</b><br>BR6HS                 | <b>13221</b><br>WF20TT     | Filetto=M14<br>Lungh. Filetto=13 mm<br>(normale) - Esagono=21    | AGRIA - HONDA -<br>KAWASAKY - ROBIN - SABO   |
| <b>12245</b><br>CR5HSB                | <b>13233</b><br>U16FSR-UB  | Filetto=M10<br>Lungh. Filetto=13 mm<br>(normale) - Esagono=16    | HONDA (Mod. UMK422D -<br>422J - 422S - 431D - 431J<br>- UMT24S)  |



### CANDELE WEGA

BOUGIES - PLUGS - KERZEN - BUJIAS

| MOTORI                 |   |  | DECESPUGLIATORI        |   |  |
|------------------------|---|--|------------------------|---|--|
| CANDELE ORIGINALI WEGA | DATI TECNICI  | APPLICAZIONI   | CANDELE ORIGINALI WEGA | DATI TECNICI  | APPLICAZIONI   |
| <b>10448</b><br>N17    | Filetto=M14<br>Lungh. Filetto=13 mm<br>(normale)<br>Esagono=21 mm | ACME-BETA-CM-COTIEMME-<br>DUCATI-INTERMOTOR-JLO-<br>LOMBARDINI-MINARELLI-VOLPI-<br>ZANETTI | <b>10448</b><br>N17    | Filetto=M14<br>Lungh. Filetto=13 mm<br>(normale)<br>Esagono=21 mm | JONSERED-<br>Mc CULLOCH  |
| MOTOSEGHE              |   |  | RASAERBA               |   |  |
| CANDELE ORIGINALI WEGA | DATI TECNICI  | APPLICAZIONI   | CANDELE ORIGINALI WEGA | DATI TECNICI  | APPLICAZIONI   |
| <b>10448</b><br>N17    | Filetto=M14<br>Lungh. Filetto=13 mm<br>(normale) - Esagono=21     | JO.BU-JONSERED-Mc CULLOCH-<br>LANDONI-PARTNER-SOLO-STIHL                                   | <b>10448</b><br>N17    | Filetto=M14<br>Lungh. Filetto=13 mm<br>(normale) Esagono=21       | AGRIA-AS MOTOR-FLYMO-HAKO-<br>JLO-JACOBSEN-ROBIN-SOLO-<br>TECUMSEH-WOLF-ZENOAH |

### CANDELA PER LOMBARDINI

BOUGIES LOMBARDINI  
LOMBARDINI SPARK PLUG  
ZÜNDKERZEN LOMBARDINI  
BUJIAS LOMBARDINI



| ARTICOLO     | DESCRIZIONE        | OEM     |
|--------------|--------------------|---------|
| <b>12923</b> | Candela LOMBARDINI | 147A131 |

### CHIAVE A "T" SNODATA PER CANDELE

CLÉ EN "T" ARTICULÉ POUR BOUGIES  
ARTICULATED "T" WRENCH FOR GLOW PLUGS  
"T"-GELENKSCHLÜSSEL FÜR ZÜNDKERZEN  
LLAVE EN "T" ARTICULADA PARA BUJIAS



FIG.1



FIG.2

| ARTICOLO     | ESAGONO mm | LUNGHEZZA mm | FIGURA |
|--------------|------------|--------------|--------|
| <b>12077</b> | 16         | 375          | 1      |
| <b>12078</b> | 21         | 375          | 2      |

### CANDELE (TABELLA DI COMPARAZIONE)

BOUGIES (tableau de comparaison) - PLUGS (conversion chart) - KERZEN (jämförelsetabell) - BUJIAS

| CERMAG                         | BOSCH   | CHAMPION   | LODGE  | MAGNETI MARELLI    | NIPPON DENSO  | CERMAG                        | BOSCH                           | CHAMPION                       | LODGE   | MAGNETI MARELLI  | NIPPON DENSO   |
|--------------------------------|---|--|--|--------------------|---|-------------------------------|---------------------------------|--------------------------------|---|--|----------------|
| <b>10053</b><br>(NGK)<br>BP5ES | W8D<br>W8DC<br>W8DCO<br>W9D<br>W9BC<br>W9DP<br>W125T30<br>W145T30 | N11Y<br>N11YC<br>N11YCC<br>N12Y<br>N12YC<br>N12YCC<br>N13Y<br>N14Y | BLNY<br>CLNY   | CW67P<br>CW67LP    | W16EP-U   | <b>10565</b><br>(NGK)<br>BM7A | WKA225T3<br>WS5E                | CJ3<br>CJ4<br>CJ6              | —   | AW56C  | W22M<br>W20M-U |
|                                | <b>10054</b><br>(NGK)<br>BP5HS                                    | W8B<br>W8BC<br>W8BP<br>W145T35                                     | L12Y<br>L89CM<br>L92Y<br>L92YC                                     | CNY                | CW5NP<br>F6NC   |                               | W16FP<br>W16FP-U                | <b>10566</b><br>(NGK)<br>BM6A  | WKA145T3<br>WKA175T3<br>WS7E<br>WS8E                              | CJ11<br>CJ8<br>CJ86  | CANC           |
| <b>10448</b><br>(WEGA)<br>N17  |   | W7A<br>W7AC<br>W7AO<br>W7AP<br>W175T1<br>W175Z1                    | L10<br>L7J<br>L82<br>L82C<br>L85<br>L86<br>L86C<br>L86CC<br>L9J    | H<br>HN            | CW67NJ<br>CW6N<br>CW6NJ<br>CW7N<br>CW7NJ<br>CWC67NJ<br>CWC6NJ<br>CWC7NJ<br>FC7N | W20FS<br>W20FS-U              | <b>10567</b><br>(NGK)<br>B5HS   |                                | W8A<br>W8AC<br>W8AO<br>W8AP<br>W9AC<br>W9ACO<br>W145T1<br>W14T1.1 | L288<br>L90  | CN<br>HBN      |
|                                | <b>10562</b><br>(NGK)<br>BPM6A                                    | W7A<br>W7AC<br>W7AO<br>W7AP<br>W175T1<br>W175Z1                    | L10<br>L7J<br>L82<br>L82C<br>L85<br>L86<br>L86C<br>L86CC<br>L9J    | H<br>HN            | CW67NJ<br>CW6N<br>CW6NJ<br>CW7N<br>CW7NJ<br>CWC67NJ<br>CWC6NJ<br>CWC7NJ<br>FC7N | W20FS<br>W20FS-U              |                                 | <b>10568</b><br>(NGK)<br>AB6   | M7A<br>M8A<br>M10A<br>M145T1                                      | D9 - D9J<br>D10 - D14<br>D16 - D16J<br>D21 - K13<br>K15J<br>RD14<br>RD16<br>RD16J<br>RD9<br>UD16<br>UK10 | CV<br>HBV      |
| <b>10563</b><br>(NGK)<br>BP6HS |   | W7A<br>W7AC<br>W7AO<br>W7AP<br>W175T1<br>W175Z1                    | L10<br>L7J<br>L82<br>L82C<br>L85<br>L86<br>L86C<br>L86CC<br>L9J    | H<br>HN            | CW67NJ<br>CW6N<br>CW6NJ<br>CW7N<br>CW7NJ<br>CWC67NJ<br>CWC6NJ<br>CWC7NJ<br>FC7N | W20FS<br>W20FS-U              | <b>11085</b><br>(NGK)<br>BR4HS  |                                | WR10A<br>WA10AC   | —  | —              |
|                                | <b>10564</b><br>(NGK)<br>B6S                                      | WKA145T6<br>WKA175T6<br>WS7F<br>WS8F                               | CJ8Y   | CANB               | —   | W20MP-U                       |                                 | <b>11342</b><br>(NGK)<br>BMR6A | —   | RCJ8   | —              |
| <b>10563</b><br>(NGK)<br>BP6HS |   | W6B<br>W6BC<br>W6BP<br>W7B<br>W7BC<br>W7BP<br>W175T35<br>W200T35   | L66Y<br>L82Y<br>L82YC<br>L82YCC<br>L85Y<br>L87Y<br>L87YC<br>L87YCC | HNY                | CW67N<br>CW6NP<br>CW7NP<br>F7NC   | W20FP<br>W20FP-U              | <b>11488</b><br>(NGK)<br>BM6F   |                                | HS8E<br>WKA145T3  | DJ7J<br>DJ8J   | —              |
|                                | <b>10564</b><br>(NGK)<br>B6S                                      | W7E<br>W7EC<br>W7EP<br>W8E<br>W8EC<br>W145T3<br>W175T3             | H03<br>J6 - J6C<br>J6J - J7<br>J7J - J8<br>J8C - J8J<br>UJ6 - UJ8  | 2HA<br>CAN<br>HBAN | CW6C<br>CW6CJ<br>CW7C   | W20S<br>W20S-U                |                                 | <b>11489</b><br>(NGK)<br>BPM7A | WKA225T6<br>WS5F  | CJ6Y<br>CJ7Y   | —              |
| <b>10564</b><br>(NGK)<br>B6S   |   | W7E<br>W7EC<br>W7EP<br>W8E<br>W8EC<br>W145T3<br>W175T3             | H03<br>J6 - J6C<br>J6J - J7<br>J7J - J8<br>J8C - J8J<br>UJ6 - UJ8  | 2HA<br>CAN<br>HBAN | CW6C<br>CW6CJ<br>CW7C   | W20S<br>W20S-U                | <b>11490</b><br>(NGK)<br>BPMR6A |                                | WKA200TR6<br>WSR6F<br>WSR8F                                       | RCJ8Y  | —              |
|                                | <b>10564</b><br>(NGK)<br>B6S                                      | W7E<br>W7EC<br>W7EP<br>W8E<br>W8EC<br>W145T3<br>W175T3             | H03<br>J6 - J6C<br>J6J - J7<br>J7J - J8<br>J8C - J8J<br>UJ6 - UJ8  | 2HA<br>CAN<br>HBAN | CW6C<br>CW6CJ<br>CW7C   | W20S<br>W20S-U                |                                 | <b>12599</b><br>BR7ES          | —   | RN4C   | —              |

### segue CANDELE (tabella di comparazione)

BOUGIES (tableau de comparaison) - PLUGS (conversion chart) - KERZEN (jämförelsetabell) - BUJIAS

| CERMAG                          | BOSCH    | CHAMPION | LODGE  | MAGNETI MARELLI | NIPPON DENSO                   | CERMAG                           | BOSCH                           | CHAMPION   | LODGE   | MAGNETI MARELLI | NIPPON DENSO        |
|---------------------------------|----------|----------|--------|-----------------|--------------------------------|----------------------------------|---------------------------------|--|---|-----------------|---------------------|
| <b>11491</b><br>(NGK)<br>BP6ES  | W6D      | N8Y      | 15HLNY | CW67LP          | W20EP-U                        | <b>11502</b><br>(NGK)<br>B7HS    | W3A-W3AC                        | L4J  | 2H  | CW8N            | W22FS               |
|                                 | W6D1     | N9Y      | 25XL   | CW75LP          |                                |                                  | W3AO-<br>W3AS                   | L5   | 2HN   | CWC9NJ          | W22FS-U             |
|                                 | W6D6C    | N9YC     | 2XL    | CW78LP          |                                |                                  | W4A-W4A1                        | L77J   |   |                 |                     |
|                                 | W6DCO    | N9YCC    | HLNY   | CW78LPS         |                                |                                  | W4A2                            | L78  |   |                 |                     |
|                                 | W6DP     | N9YCX    |        | CW7LPN          |                                |                                  | W4A5                            | L78C   |   |                 |                     |
|                                 | W6DPO    | N10Y     |        | F7LC            |                                |                                  | W4AC                            | L81  |   |                 |                     |
|                                 | W7D      | N66Y     |        |                 |                                |                                  | W4AP                            | UL4J   |   |                 |                     |
|                                 | W7DC     | N79Y     |        |                 |                                |                                  | W4AC3                           | UL81C  |   |                 |                     |
|                                 | W7DO     | UN79Y    |        |                 |                                |                                  | W5A-W5AC                        | UL81J  |   |                 |                     |
|                                 | W7DP     |          |        |                 |                                |                                  | W5AP                            |  |   |                 |                     |
| W175T30                         |          |          |        |                 | W221T1                         |                                  |                                 |  |   |                 |                     |
| W200T30                         |          |          |        |                 | W4C3                           |                                  |                                 |  |   |                 |                     |
| W215T30                         |          |          |        |                 |                                |                                  |                                 |  |   |                 |                     |
| <b>11492</b><br>(NGK)<br>BR6HS  | WR7A     | QL7J5    | —      | CW6NR           | WF20TT                         | <b>12175</b><br>(NGK)<br>BCPR5ES | —                               | —  | —   | —               | Q16PR-U             |
|                                 | WR7AC    | QL86     |        | CW7NR           |                                |                                  | <b>12176</b><br>(NGK)<br>BMR7A  | —  | RCJ4<br>RCJ6  | —               | W22M-U              |
|                                 | WR10E    | RL7J     |        | CW67NR          |                                |                                  | <b>12177</b><br>(NGK)<br>BPMR7A | WRS5F<br>WSR5F   | RCJ6Y<br>RCJ7Y  | —               | W22MPR-U            |
|                                 | W175TR1  | RL82     |        |                 |                                |                                  | <b>12178</b><br>(NGK)<br>BR6ES  | W125TR3<br>W145TR3<br>WR8E<br>WR8EP-WR9E<br>WR9EC<br>WR9EO | RJ6-RJ6C<br>RJ6J-RJ7<br>RJ8-RJ8C<br>RJ8J-RJ11<br>RJ12 | DW4CJR          | W20SR-U<br>W20ESR-U |
| <b>11494</b><br>(NGK)<br>BPR4HS | —        | —        | —      | —               | W14FPR-L<br>W14FPR-UL          | <b>12179</b><br>(NGK)<br>BR4-LM  | WR11EO                          | RJ17LM   | —   | —               | W14LM-U             |
|                                 |          |          |        |                 |                                |                                  | <b>12180</b><br>(NGK)<br>BR2-LM | —  | RJ19LM  | —               | W9LMR-US            |
|                                 |          |          |        |                 |                                |                                  | <b>12181</b><br>(NGK)<br>BKR5ES | —  | RC12YC  | —               | K16PR-U             |
|                                 |          |          |        |                 |                                |                                  | <b>12245</b><br>(NGK)<br>CR5HSB | —  | —   | —               | —                   |
| <b>11495</b><br>(NGK)<br>BPR5ES | W125TR30 | ON11Y    | —      | —               | W16EPR-U                       | <b>12466</b><br>(NGK)<br>CMR5H   | —                               | —  | —   | —               | —                   |
|                                 | W145TR30 | ON12Y    |        |                 |                                |                                  | <b>12468</b><br>CMR6A           | —  | —   | —               | —                   |
|                                 | WR8D     | RN11Y    |        |                 |                                |                                  | <b>12476</b><br>BPR6ES          | —  | —   | —               | —                   |
|                                 | WR8DC    | RN11YC   |        |                 |                                |                                  | <b>12625</b><br>(NGK)<br>BCP6ES | —  | —   | —               | —                   |
|                                 | WR8DCO   | RN11YCC  |        |                 |                                |                                  | <b>12626</b><br>(NGK)<br>B-4H   | —  | —   | —               | —                   |
| WR8DP                           | RN12Y    |          |        |                 | <b>12627</b><br>(NGK)<br>CMR6H | —                                | —                               | —  | —   |                 |                     |
| WR9D                            | RN12YC   |          |        |                 | <b>12828</b><br>(NGK)<br>CMR6H | —                                | —                               | —  | —   |                 |                     |
| WR9DC                           | RN12YCC  |          |        |                 | <b>12829</b><br>(NGK)<br>CMR7A | —                                | —                               | —  | —   |                 |                     |
| WR9DP                           | RN14Y    |          |        |                 |                                |                                  |                                 |  |   |                 |                     |
| <b>11496</b><br>(NGK)<br>B4LM   | W9ECO    | CJ17LM   | —      | —               | W14LM-U<br>W14LM-US            |                                  |                                 |  |   |                 |                     |
|                                 | W9EO     | J17LM    |        |                 |                                |                                  |                                 |  |   |                 |                     |
|                                 |          |          |        |                 |                                |                                  |                                 |  |   |                 |                     |
|                                 |          |          |        |                 |                                |                                  |                                 |  |   |                 |                     |
| <b>11497</b><br>(NGK)<br>BL6H   | —        | —        | —      | —               | —                              |                                  |                                 |  |   |                 |                     |
|                                 |          |          |        |                 |                                |                                  |                                 |  |   |                 |                     |
|                                 |          |          |        |                 |                                |                                  |                                 |  |   |                 |                     |
|                                 |          |          |        |                 |                                |                                  |                                 |  |   |                 |                     |
|                                 |          |          |        |                 |                                |                                  |                                 |  |   |                 |                     |
|                                 |          |          |        |                 |                                |                                  |                                 |  |   |                 |                     |
|                                 |          |          |        |                 |                                |                                  |                                 |  |   |                 |                     |
|                                 |          |          |        |                 |                                |                                  |                                 |  |   |                 |                     |
|                                 |          |          |        |                 |                                |                                  |                                 |  |   |                 |                     |
|                                 |          |          |        |                 |                                |                                  |                                 |  |   |                 |                     |
| <b>11498</b><br>(NGK)<br>B6HS   | W7A      | L10      | H      | CW67NJ          | W20FS                          |                                  |                                 |  |   |                 |                     |
|                                 | W7AC     | L7J      | HN     | CW6N            | W20FS-U                        |                                  |                                 |  |   |                 |                     |
|                                 | W7AO     | L82      |        | CW6NJ           | W20FP-U                        |                                  |                                 |  |   |                 |                     |
|                                 | W7AP     | L82C     |        | CW7N            |                                |                                  |                                 |  |   |                 |                     |
|                                 | W175T1   | L85      |        | CW7NJ           |                                |                                  |                                 |  |   |                 |                     |
|                                 | W175Z1   | L86      |        | CWC67NJ         |                                |                                  |                                 |  |   |                 |                     |
|                                 |          | L86C     |        | CWC6NJ          |                                |                                  |                                 |  |   |                 |                     |
|                                 |          | L86CC    |        | CWC7NJ          |                                |                                  |                                 |  |   |                 |                     |
|                                 |          | L9J      |        | FC7N            |                                |                                  |                                 |  |   |                 |                     |
|                                 |          |          |        |                 |                                |                                  |                                 |  |   |                 |                     |

### ATTACCHI CANDELA

ATTAQUE BOUGIES - SPARK-PLUGS SOCKET - KERZEN EINSATZ - ATAQUE BUJIAS

#### TIPO SUPER CON INNESTO A VITE

TYPE SUPER AVEC VIS  
SUPER TYPE WITH SCREW CONNECTION  
TYP SUPER MIT VERSCHRAUBUNG  
TIPO SUPER CON CONEXIÓN DE TORNILLO



| ARTICOLO     |
|--------------|
| <b>11865</b> |

#### TIPO NGK CON RESISTENZA PER MOTORI HONDA - KAWASAKI

TYPE NGK AVEC RESISTANCE POUR MOTEURS HONDA - KAWASAKI  
NGK TYPE WITH RESISTANCE FOR HONDA - KAWASAKI MOTORS  
TYP NGK MIT WIDERSTAND FÜR MOTOREN HONDA - KAWASAKI  
TIPO NGK CON RESISTENCIA PARA MOTORES HONDA - KAWASAKI



| ARTICOLO     |
|--------------|
| <b>11871</b> |

#### TIPO IN MOPLEN COMPLETO DI INNESTO

TYPE EN MOPLEN AVEC BRANCHEMENT  
TYPE IN MOPLEN COMPLETE WITH CONNECTION  
TYP AUS MOPLEN KOMPLETT MIT ANSCHLUSS  
TIPO EN MOPLEN CON ACOPLAMIENTO



| ARTICOLO     | Ø mm         | CONF. MINIMA |
|--------------|--------------|--------------|
| <b>10706</b> | per filo Ø 7 | 10           |

#### ATTACCO CANDELA LOMBARDINI STANDARD

ATTAQUE BOUGIES LOMBARDINI STANDARD  
SPARK-PLUG SOCKETS STANDARD LOMBARDINI  
ZUENDKERZENSTECKER PASSEND FUER LOMBARDINI  
CONEXIONES BUJIA STANDARD LOMBARDINI



| ARTICOLO     | OEM     |
|--------------|---------|
| <b>12924</b> | 1450128 |

#### TIPO STANDARD COMPLETO DI INNESTO A VITE

TYPE STANDARD AVEC VIS  
STANDARD TYPE COMPLETE WITH SCREW CONNECTION  
TYP STANDARD KOMPLETT MIT VERSCHRAUBUNG  
TIPO STANDARD CON CONEXIÓN DE TORNILLO



| ARTICOLO     | Ø mm         | CONF. MINIMA |
|--------------|--------------|--------------|
| <b>11866</b> | per filo Ø 5 | 10           |
| <b>11867</b> | per filo Ø 7 | 10           |

#### TIPO CON MOLLA

TYPE AVEC RESSORT  
TYPE WITH SPRING  
TYP MIT FEDER  
TIPO CON RESORTE



| ARTICOLO     | Ø mm         | CONF. MINIMA |
|--------------|--------------|--------------|
| <b>11868</b> | per filo Ø 5 | 10           |
| <b>11869</b> | per filo Ø 7 | 10           |

#### CAVO CANDELA STANDARD

CÂBLE BOUGIES-STANDARD  
SPARK-PLUGS CABLE STANDARD  
KERZEN KABEL STANDARD  
CABLE BUJIAS STANDARD



| ARTICOLO     | DESCRIZIONE          |
|--------------|----------------------|
| <b>11874</b> | Cavo standard Ø 7 mm |

### FILTRI ARIA IN SPUGNA PER GIARDINAGGIO

FILTRO - FILTER - FILTER - FILTRO

ASPERA - TECUMSEH - TECNAMOTOR



| ARTICOLO     | APPLICAZIONE      | MISURE          | OEM      |
|--------------|-------------------|-----------------|----------|
| <b>12771</b> | BVS143<br>BVS 153 | 145x40x32<br>mm | 23410026 |

ASPERA - TECUMSEH - TECNAMOTOR



| ARTICOLO     | APPLICAZIONE             | MISURE          | OEM   |
|--------------|--------------------------|-----------------|-------|
| <b>12514</b> | TVS 75-90-105<br>TVS 840 | 135x40x40<br>mm | 34340 |

ASPERA - TECUMSEH - TECNAMOTOR



| ARTICOLO     | APPLICAZIONE                                    | MISURE         | OEM   |
|--------------|---|----------------|-------|
| <b>12522</b> | LAV 30 a LAV 50<br>TVS 75-90-105<br>TVS 120-150 | 72x60x50<br>mm | 33006 |

ASPERA - TECUMSEH - TECNAMOTOR



| ARTICOLO     | APPLICAZIONE       | MISURE          | OEM   |
|--------------|--------------------|-----------------|-------|
| <b>12616</b> | TNT 100<br>TNT 120 | 100x52x38<br>mm | 33896 |

ASPERA - TECUMSEH - TECNAMOTOR



| ARTICOLO     | APPLICAZIONE     | MISURE | OEM   |
|--------------|------------------|--------|-------|
| <b>12706</b> | TVS 75<br>TVS 90 | -      | 35604 |

BRIGGS &amp; STRATTON



| ARTICOLO     | APPLICAZIONE  | MISURE           | OEM    |
|--------------|---|------------------|--------|
| <b>12711</b> | 4HP verticali<br>110000 a 110999<br>111900 a 111999 | 140x102x36<br>mm | 270848 |

BRIGGS &amp; STRATTON



| ARTICOLO     | APPLICAZIONE            | MISURE          | OEM   |
|--------------|-------------------------|-----------------|-------|
| <b>12714</b> | 4HP verticali<br>100900 | 144x90x37<br>mm | 27987 |

BRIGGS &amp; STRATTON



| ARTICOLO     | APPLICAZIONE  | MISURE           | OEM    |
|--------------|---|------------------|--------|
| <b>12726</b> | 10-11 HP verticali<br>251700 a 252700<br>3-3,5H Starter Auto. | 240x118x38<br>mm | 270579 |

BRIGGS &amp; STRATTON



| ARTICOLO     | APPLICAZIONE         | MISURE          | OEM    |
|--------------|----------------------|-----------------|--------|
| <b>12731</b> | 3-3,5 HP<br>1° Serie | 145x92x38<br>mm | 270251 |

BRIGGS &amp; STRATTON



| ARTICOLO     | APPLICAZIONE            | MISURE          | OEM    |
|--------------|-------------------------|-----------------|--------|
| <b>12732</b> | 4HP verticali<br>100900 | 144x90x37<br>mm | 270067 |

BRIGGS &amp; STRATTON



| ARTICOLO     | APPLICAZIONE                        | MISURE           | OEM    |
|--------------|-------------------------------------|------------------|--------|
| <b>12760</b> | 10-11HP vert.<br>251700 a<br>252700 | 240x118x38<br>mm | 270843 |

BRIGGS &amp; STRATTON



| ARTICOLO     | APPLICAZIONE         | MISURE           | OEM    |
|--------------|----------------------|------------------|--------|
| <b>12761</b> | 6-7-8HP<br>verticali | 216x110x39<br>mm | 270528 |

BRIGGS &amp; STRATTON



| ARTICOLO     | APPLICAZIONE   | MISURE          | OEM    |
|--------------|--|-----------------|--------|
| <b>12769</b> | Sprint-Classic<br>Quattro<br>3-3,5HP Carb. memb.<br>con primer | 150x90x32<br>mm | 272235 |

BRIGGS &amp; STRATTON



| ARTICOLO     | APPLICAZIONE  | MISURE           | OEM    |
|--------------|---------------|------------------|--------|
| <b>12770</b> | 5HP verticali | 148x105x38<br>mm | 270447 |

BRIGGS &amp; STRATTON

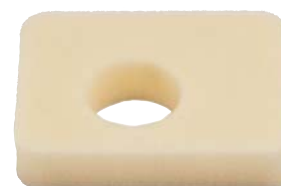

| ARTICOLO     | APPLICAZIONE                  | MISURE | OEM    |
|--------------|-------------------------------|--------|--------|
| <b>12842</b> | 550E - 550EX<br>09P602-09P702 | -      | 799579 |

### segue FILTRI ARIA IN SPUGNA PER GIARDINAGGIO

FILTRO - FILTER - FILTER - FILTRO



FILTRO KAWASAKI  
TD40 - TD48

ARTICOLO  
**12312**



FILTRO KAWASAKI  
TD18 - TD24

ARTICOLO  
**12313**



FILTRO KAWASAKI  
TJ 27

ARTICOLO  
**12845**



FILTRO KAWASAKI  
TJ 35 (OEM 11013-2229)

ARTICOLO  
**12846**



FILTRO KAWASAKI  
TJ 45 (OEM 11013-2226)

ARTICOLO  
**12844**



FILTRO KAWASAKI  
TJ 53 (OEM 11013-2242)

ARTICOLO  
**12843**



FILTRO MITSUBISHI  
T110-130-140-180-200-240

ARTICOLO  
**12314**



FILTRO SHINDAIWA  
CB35-CB45-BP35-BP45

ARTICOLO  
**12390**



FILTRO TANAKA  
322 - 262

ARTICOLO  
**12389**



FILTRO TANAKA  
440

ARTICOLO  
**12315**



FILTRO TANAKA  
210

ARTICOLO  
**12316**



FILTRO WALBRO  
WZ

ARTICOLO  
**12311**

segue **FILTRI ARIA IN SPUGNA PER GIARDINAGGIO**  
 FILTRO - FILTER - FILTER - FILTRO



FILTRO ZENOAH BK351-HB2300  
 MARUYAMA M45 - AE420  
 MITSUBISHI TL50

ARTICOLO  
**12391**



FILTRO ZENOAH  
 BK4300

ARTICOLO  
**12392**



FILTRO ZENOAH  
 BC2200

ARTICOLO  
**12393**



FILTRO ZENOAH  
 250 - 2500

ARTICOLO  
**12317**



FILTRO ZENOAH  
 BC3500

ARTICOLO  
**12386**



FILTRO ZENOAH  
 CHT 2300 tagliasiepi

ARTICOLO  
**12388**



FILTRO ZENOAH  
 3100

ARTICOLO  
**13096**

### FILTRI ARIA IN CARTA PER GIARDINAGGIO

FILTRO - FILTER - FILTER - FILTRO



| ARTICOLO     | APPLICAZIONE                 | MISURE                             | OEM  |
|--------------|------------------------------|------------------------------------|------|
| <b>12545</b> | AS MOTOREN<br>1ª generazione | H=75<br>Ø EST=70<br>Ø INT=38<br>mm | 4221 |



| ARTICOLO     | APPLICAZIONE                 | MISURE                             | OEM  |
|--------------|------------------------------|------------------------------------|------|
| <b>12497</b> | AS MOTOREN<br>2ª generazione | H=65<br>Ø EST=60<br>Ø INT=36<br>mm | 7545 |

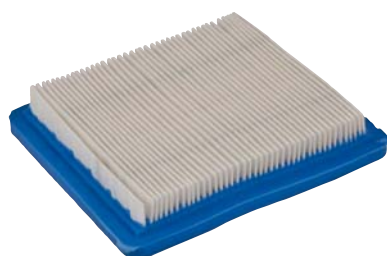

PREFILTRO  
**12517**

new



| ARTICOLO     | APPLICAZIONE  | MISURE           | OEM                |
|--------------|---|------------------|--------------------|
| <b>12036</b> | BRIGGS & STRATTON<br>QUANTUM 3,5 - 5 HP<br>ORIZZONTALE 3 - 5 HP | 133x114x25<br>mm | 491.588<br>399.959 |

| ARTICOLO     | APPLICAZIONE   | MISURE          | OEM             |
|--------------|--|-----------------|-----------------|
| <b>13276</b> | BRIGGS & STRATTON<br>450E - 500E - 550E - 575E -<br>625E - 650E - 675E | 110x68x35<br>mm | 798452<br>59326 |



| ARTICOLO                        | APPLICAZIONE  | MISURE              | OEM              |
|---------------------------------|---|---------------------|------------------|
| <b>12038</b><br><b>FDAF4574</b> | BRIGGS & STRATTON<br>MOTORI 8 HP - 10 HP<br>13 HP - 16 HP | H=96<br>Ø=108<br>mm | 393957<br>390930 |



| ARTICOLO     | APPLICAZIONE                                | MISURE                 | OEM    |
|--------------|---|------------------------|--------|
| <b>12040</b> | BRIGGS & STRATTON<br>MOTORE ORIZZONTALE 5HP | H = 71<br>Ø = 70<br>mm | 392308 |

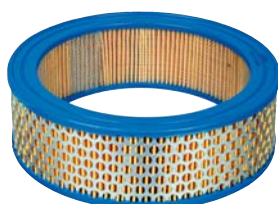

| ARTICOLO     | APPLICAZIONE                        | MISURE                  | OEM              |
|--------------|-------------------------------------|-------------------------|------------------|
| <b>12116</b> | BRIGGS & STRATTON<br>VANGUARD 16 HP | H = 55<br>Ø = 180<br>mm | 394018<br>392642 |

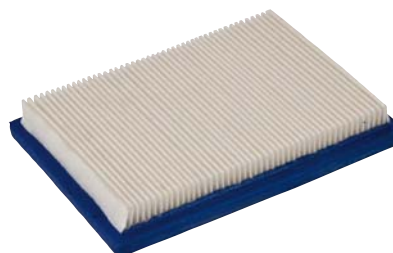

| ARTICOLO     | APPLICAZIONE  | MISURE           | OEM               |
|--------------|---|------------------|-------------------|
| <b>12034</b> | BRIGGS & STRATTON<br>2 TEMPI 4HP<br>3,5 MAX - 4 MAX | 160x114x20<br>mm | 397.795<br>395027 |



### segue FILTRI ARIA IN CARTA PER GIARDINAGGIO

FILTRO - FILTER - FILTER - FILTRO



| ARTICOLO     | APPLICAZIONE                                | MISURE               | OEM    |
|--------------|---|----------------------|--------|
| <b>12039</b> | BRIGGS & STRATTON<br>MOTORE ORIZZONTALE 5HP | H = 71<br>Ø=70<br>mm | 396424 |



| ARTICOLO     | APPLICAZIONE                        | MISURE           | OEM     |
|--------------|-------------------------------------|------------------|---------|
| <b>12035</b> | BRIGGS & STRATTON<br>QUANTUM 35 4HP | 117x117x22<br>mm | 399.877 |



| ARTICOLO     | APPLICAZIONE                      | MISURE           | OEM    |
|--------------|-----------------------------------|------------------|--------|
| <b>12032</b> | BRIGGS & STRATTON<br>VANGUARD 9HP | 185x160x38<br>mm | 491384 |



| ARTICOLO     | APPLICAZIONE  | MISURE          | OEM              |
|--------------|---|-----------------|------------------|
| <b>12498</b> | BRIGGS & STRATTON<br>per motore albero<br>VERTECALE da 12 a 15 HP | 184x73x76<br>mm | 496894<br>493909 |



| ARTICOLO     | APPLICAZIONE                             | MISURE           | OEM              |
|--------------|--|------------------|------------------|
| <b>12480</b> | BRIGGS & STRATTON<br>INTEK da 14 a 24 HP | 178x102x38<br>mm | 499486<br>632312 |



| ARTICOLO     | APPLICAZIONE      | MISURE          | OEM                        |
|--------------|-------------------|-----------------|----------------------------|
| <b>12481</b> | BRIGGS & STRATTON | 130x80x38<br>mm | 623171<br>697775<br>698313 |

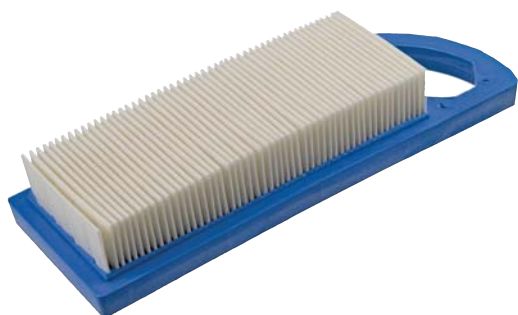

| ARTICOLO     | APPLICAZIONE  | MISURE          | OEM                                  |
|--------------|---|-----------------|--------------------------------------|
| <b>12482</b> | BRIGGS & STRATTON<br>Series 284H07 - 285H07 - 286H770 -<br>31E700 - 31G700 - 31H700 - INTEK AVS | 222x79x38<br>mm | 697014<br>697634<br>698083<br>697776 |



| ARTICOLO     | APPLICAZIONE  | MISURE           | OEM     |
|--------------|---|------------------|---------|
| <b>12033</b> | BRIGGS & STRATTON<br>VANGUARD 9HP - 12,5HP<br>14HP - 16HP | 185x160x18<br>mm | 805.113 |

### segue FILTRI ARIA IN CARTA PER GIARDINAGGIO

FILTRO - FILTER - FILTER - FILTRO

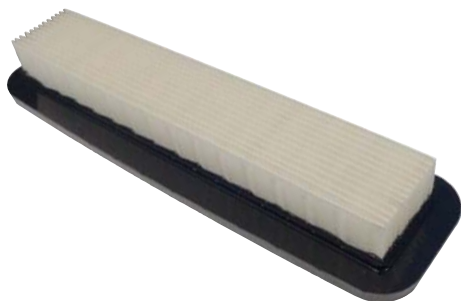

| ARTICOLO     | APPLICAZIONE  | MISURE          | OEM          |
|--------------|---|-----------------|--------------|
| <b>13099</b> | SOFFIATORE<br>ECHO PB460-PB750-PB4600-PB6000<br>SHINDAIWA EB633RT | 265x74x35<br>mm | 130305-08360 |



| ARTICOLO     | APPLICAZIONE                 | MISURE                    | OEM                  |
|--------------|------------------------------|---------------------------|----------------------|
| <b>12055</b> | HONDA<br>MOTOZAPPA F510-F560 | H 57 mm<br>Ø 120/68<br>mm | 17210<br>734-003/505 |



| ARTICOLO     | APPLICAZIONE                     | MISURE                    | OEM                         |
|--------------|----------------------------------|---------------------------|-----------------------------|
| <b>12056</b> | HONDA<br>GX140 -<br>GX160 5HP OR | H 70 mm<br>Ø 102/75<br>mm | 17210 - ZE1-<br>821/822/505 |



| ARTICOLO     | APPLICAZIONE  | MISURE                    | OEM  |
|--------------|---|---------------------------|--|
| <b>12057</b> | HONDA<br>GXV120 - GXV140-GV150<br>GV200 - 3,5HP-4HP-5HP | H 50 mm<br>Ø 187/62<br>mm | 17210-ZE6-<br>003/505<br>17211-888-<br>013/015/505 |



| ARTICOLO     | APPLICAZIONE                 | MISURE                    | OEM                       |
|--------------|------------------------------|---------------------------|---------------------------|
| <b>12058</b> | HONDA<br>GX V 120 - GX V 160 | H 48 mm<br>Ø 187/62<br>mm | 17210-ZE7-<br>013/505/003 |



| ARTICOLO     | APPLICAZIONE      | MISURE          | OEM                    |
|--------------|-------------------|-----------------|------------------------|
| <b>12059</b> | HONDA<br>GX V 140 | 136x58x25<br>mm | 17211-ZG9-<br>800/8000 |



| ARTICOLO     | APPLICAZIONE  | MISURE          | OEM                         |
|--------------|---|-----------------|-----------------------------|
| <b>12060</b> | HONDA: GX V 140 - GX V 150 - GX V 160<br>KOHLER: XT 149 / 173 / 650 / 675 / 800 | 148x89x25<br>mm | 17211-ZG9-M000<br>1408301-S |

### segue FILTRI ARIA IN CARTA PER GIARDINAGGIO

FILTRO - FILTER - FILTER - FILTRO



| ARTICOLO     | APPLICAZIONE             | MISURE                 | OEM                   |
|--------------|--------------------------|------------------------|-----------------------|
| <b>12061</b> | HONDA<br>GX 240 - GX 270 | H 78 mm<br>Ø 102/89 mm | 17210-ZE2-822/821/882 |



| ARTICOLO     | APPLICAZIONE             | MISURE       | OEM                   |
|--------------|--------------------------|--------------|-----------------------|
| <b>12062</b> | HONDA<br>GX 340 - GX 390 | 112x96x92 mm | 17210-ZE3-000/010/505 |



| ARTICOLO                         | APPLICAZIONE                              | MISURE       | OEM                   |
|----------------------------------|---|--------------|-----------------------|
| <b>12488</b><br><b>FDAF25471</b> | HONDA<br>GX110 old 3,5HP<br>GX120 new 4HP | 102x73x54 mm | 17210-ZE0-505/821/822 |

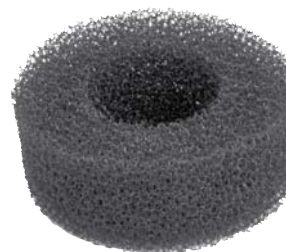

| ARTICOLO     | APPLICAZIONE | MISURE                          | OEM           |
|--------------|--------------|---------------------------------|---------------|
| <b>12516</b> | HONDA        | H=32<br>ØEst.=74<br>ØInt.=33 mm | 17403-ZE1-810 |



| ARTICOLO     | APPLICAZIONE  | MISURE        | OEM                            |
|--------------|---|---------------|--------------------------------|
| <b>12629</b> | HONDA GC 135-160-190<br>GCV 135-160-190<br>GS 160-190 - GSV 160-190 | 131x114x24 mm | 17211-ZL8-000<br>17211-ZL8-003 |

**new**



| ARTICOLO     | APPLICAZIONE  | MISURE      | OEM        |
|--------------|---|-------------|------------|
| <b>13275</b> | HUSQUARNA<br>345FR -<br>545FX - 545FXT - 545RX - 545RXT | 95x84x20 mm | 5476680-03 |



| ARTICOLO     | APPLICAZIONE                                   | MISURE       | OEM                                   |
|--------------|--|--------------|---------------------------------------|
| <b>12484</b> | KAWASAKI<br>FC180 (6HP)<br>FJ180V-AS04 (6,5HP) | 200x60x25 mm | 11029<br>7010/7016/7021<br>11013-2151 |



| ARTICOLO                        | APPLICAZIONE         | MISURE                      | OEM    |
|---------------------------------|----------------------|-----------------------------|--------|
| <b>12477</b><br><b>FDAF1651</b> | KOHLER<br>K181 (8HP) | H 57<br>ØE. 111<br>ØI. 76mm | 231847 |

### segue FILTRI ARIA IN CARTA PER GIARDINAGGIO

FILTRO - FILTER - FILTER - FILTRO



| ARTICOLO     | APPLICAZIONE  | MISURE         | OEM       |
|--------------|---|----------------|-----------|
| <b>13094</b> | DECESPUGLIATORE<br>OLEOMAC BC250 - BC270 - BC280 -<br>BC300 - BC320 - BC380 - BC420 | 72x62x25<br>mm | 61170016R |



| ARTICOLO     | APPLICAZIONE  | MISURE         | OEM       |
|--------------|---|----------------|-----------|
| <b>13095</b> | DECESPUGLIATORE<br>OLEOMAC 746 - 753 - 755 -<br>BP446 - BP453 | 90x66x25<br>mm | 61120018R |

new



| ARTICOLO     | APPLICAZIONE                                   | MISURE          | OEM        |
|--------------|--|-----------------|------------|
| <b>13274</b> | DECESPUGLIATORE<br>OLEOMAC 741 - BC350 - BC400 | 100x87x20<br>mm | 61380013AR |



| ARTICOLO     | APPLICAZIONE                   | MISURE          | OEM         |
|--------------|--------------------------------|-----------------|-------------|
| <b>13100</b> | SOFFIATORE<br>SHINDAIWA EB8510 | 127x92x25<br>mm | 68900-82120 |



| ARTICOLO     | APPLICAZIONE                                    | MISURE          | OEM         |
|--------------|---|-----------------|-------------|
| <b>13103</b> | DECESPUGLIATORE<br>STIHL BR500 - BR5501 - BR600 | 131x80x35<br>mm | 42821410300 |



| ARTICOLO     | APPLICAZIONE  | MISURE         | OEM         |
|--------------|---|----------------|-------------|
| <b>13101</b> | DECESPUGLIATORE<br>STIHL FS240 - FS260 - FS360 - FS410<br>- FS460 | 85x75x22<br>mm | 41471410300 |

new



| ARTICOLO     | APPLICAZIONE                                  | MISURE          | OEM         |
|--------------|---|-----------------|-------------|
| <b>13273</b> | DECESPUGLIATORE<br>STIHLFS490 - FS510 - FS560 | 104x82x25<br>mm | 41481410300 |

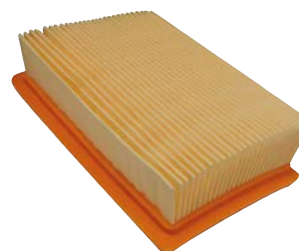

| ARTICOLO     | APPLICAZIONE   | MISURE          | OEM          |
|--------------|--|-----------------|--------------|
| <b>13102</b> | SOFFIATORE<br>STIHL BR340 - BR380 - BR400 - BR420<br>SR320 - SR340 - SR400 | 130x88x36<br>mm | 42031410301A |

### segue FILTRI ARIA IN CARTA PER GIARDINAGGIO

FILTRO - FILTER - FILTER - FILTRO



| ARTICOLO     | APPLICAZIONE                                       | MISURE         | OEM         |
|--------------|--|----------------|-------------|
| <b>13104</b> | TAGLIASIEPE<br>STIHL HS81T - HS82T - HS86R - HS87T | 88x68x24<br>mm | 42371410300 |

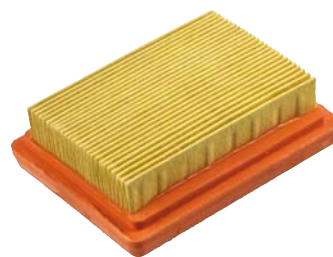

| ARTICOLO     | APPLICAZIONE   | MISURE | OEM               |
|--------------|--|--------|-------------------|
| <b>12483</b> | STIHL<br>BT120-FR350-FR450-FS120-FS200-<br>FS250-FS300-FS350-FS400-FS450 | -      | 41341410300<br>/A |



| ARTICOLO                        | APPLICAZIONE   | MISURE                     | OEM               |
|---------------------------------|--|----------------------------|-------------------|
| <b>12487</b><br><b>FDAF4525</b> | STIHL<br>TS350-TS360-TS510-BT360-TS08S-<br>TS08-TS50-TS760 | H 70<br>ØE. 98<br>ØI. 60mm | 4201-141-<br>0300 |



| ARTICOLO     | APPLICAZIONE           | MISURE                      | OEM                            |
|--------------|------------------------|-----------------------------|--------------------------------|
| <b>12493</b> | STIHL<br>TS460-510-760 | H 59<br>ØE. 113<br>ØI. 52mm | 4221-140-4400<br>4221-141-0300 |

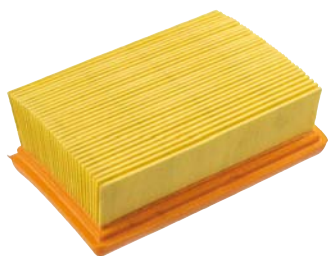

| ARTICOLO                         | APPLICAZIONE   | MISURE          | OEM           |
|----------------------------------|----------------|-----------------|---------------|
| <b>12478</b><br><b>FDAF25855</b> | STIHL<br>TS400 | 51x76x133<br>mm | 4223-141-0300 |



| ARTICOLO     | APPLICAZIONE   | MISURE          | OEM                 |
|--------------|--|-----------------|---------------------|
| <b>12063</b> | TECNAMOTOR - TECUMSEH (ASPERA)<br>PREMIER - OHV<br>TVS - TVS 105 + 120 | 181x55x20<br>mm | 355.00<br>2341-0030 |



| ARTICOLO     | APPLICAZIONE                               | MISURE             | OEM                                 |
|--------------|--|--------------------|-------------------------------------|
| <b>12064</b> | TECNAMOTOR - TECUMSEH (ASPERA)<br>BVL - BH | H 60 mm<br>Ø 58 mm | 2341.0027<br>2341.0009<br>2341.0022 |



| ARTICOLO     | APPLICAZIONE   | MISURE          | OEM       |
|--------------|--|-----------------|-----------|
| <b>12485</b> | TECNAMOTOR - TECUMSEH (ASPERA)<br>GEOTEC<br>GEOTEC OHV | 134x69x32<br>mm | 2341-0061 |

### RACCORDI - PRESE RUBINETTO - ADATTATORI - RACCORDI A SCATTO - GIUNTI RIPARATORI

RACCORDS-PRISES ROBINET-ADAPTATEURS-RACCORDS A BRANCHEMENT-JOINTS REPARATEURS - UNIONS-COCK CONNECTIONS-ADAPTERS-SNAP FITTINGS-REPAIR COLLARS - ANSCHLÜSSE-HAHNSTÜCKE-ADAPTER-STECKKUPPLUNGEN-REPARATURKUPPLUNGEN - RACORES-TOMAS GRIFO-ADAPTADORES-RACORES DE DISPARO-JUNTAS REPARADORAS

#### PRESA PER RUBINETTI FILETTATI

PRISE POUR ROBINETS FILETES  
CONNECTION FOR THREADED COCKS  
HAHNSTÜCKE MIT GEWINDE  
TOMA PARA GRIFOS ROSCADOS



#### PRESA PER RUBINETTI FILETTATI

PRISE POUR ROBINETS FILETES  
CONNECTION FOR THREADED COCKS  
HAHNSTÜCKE MIT GEWINDE  
TOMA PARA GRIFOS ROSCADOS



| ARTICOLO     | DESCRIZIONE                             |
|--------------|---|
| <b>26400</b> | Per rubinetti 3/4G (ø esterno 20-27 mm) |

| ARTICOLO     | DESCRIZIONE                           |
|--------------|---------------------------------------|
| <b>26963</b> | Per rubinetti 1G (ø esterno 26-34 mm) |

#### PRESA PER RUBINETTI FILETTATI DOTATA DI RIDUZIONE

PRISE POUR ROBINETS FILETES DOTEE DE RÉDUCTEUR  
CONNECTION FOR THREADED COCKS WITH REDUCER  
HAHNSTÜCKE MIT GEWINDE MIT REDUZIERSTÜCK  
TOMA PARA GRIFOS ROSCADOS CON REDUCCIÓN



#### PRESA PER RUBINETTI CON ADATTATORE

PRISE POUR ROBINETS AVEC ADAPTATEUR  
COCK CONNECTION WITH ADAPTER  
HAHNSTÜCKE MIT ADAPTER  
TOMA PARA GRIFOS CON ADAPTADOR



| ARTICOLO     | DESCRIZIONE  |
|--------------|--|
| <b>26964</b> | Per rubinetti 3/4G (ø est. 20-27 mm) e adattatore 1/2G (ø est. 15-21 mm) |

| ARTICOLO     | DESCRIZIONE  |
|--------------|--|
| <b>26965</b> | Con raccordo in ottone 3/4G e M24x1 est. + 22x1 int. |

#### PRESA PER RUBINETTI FILETTATI

PRISE POUR ROBINETS FILETES  
CONNECTION FOR THREADED COCKS  
HAHNSTÜCKE MIT GEWINDE  
TOMA PARA GRIFOS ROSCADOS



#### ADATTATORE PER RUBINETTI

ADAPTATEUR POUR ROBINETS  
COCK ADAPTER  
HAHNADAPTER  
ADAPTADOR PARA GRIFOS



| ARTICOLO     | DESCRIZIONE  |
|--------------|--|
| <b>27149</b> | Per rubinetti 3/4G (ø est. 20-27 mm) e adattatore 1G (ø est. 26-34 mm) |

| ARTICOLO     | DESCRIZIONE                                 |
|--------------|---|
| <b>26966</b> | Adattatore da 1" e 1/4 femmina e 1" maschio |

#### PRESA RUBINETTO A DOPPIA USCITA

PRISE POUR ROBINET A DOUBLE SORTIE  
COCK CONNECTION WITH DOUBLE OUTLET  
HAHNSTÜCKE MIT DOPPELTEM AUSGANG  
TOMA GRIFO DE DOBLE SALIDA



#### RACCORDO 1/2" PORTAGOMMA A SCATTO APERTO

RACCORD 1/2" TUYAU A BRANCHEMENT OUVERT  
OPEN SNAP-FIT 1/2" HOSE ADAPTER  
STECKKUPPLUNG 1/2" FÜR SCHLAUCH  
RACOR 1/2" PORTAGOMA DE DISPARO ABIERTO



| ARTICOLO     | DESCRIZIONE                             |
|--------------|---|
| <b>26967</b> | Per rubinetti 3/4G (ø esterno 20-27 mm) |

| ARTICOLO     | DESCRIZIONE  |
|--------------|--|
| <b>26403</b> | Per tubi ø int. da 1/2" a 5/8" (da 12,5 a 15,5 mm) |

segue **RACCORDI - PRESE RUBINETTO - ADATTATORI - RACCORDI A SCATTO - GIUNTI RIPARATORI**

RACCORDS-PRISES ROBINET-ADAPTATEURS-RACCORDS A BRANCHEMENT-JOINTS REPARATEURS - UNIONS-COCK CONNECTIONS-ADAPTERS-SNAP FITTINGS-REPAIR COLLARS - ANSCHLÜSSE-HAHNSTÜCKE-ADAPTER-STECKKUPPLUNGEN-REPARATURKUPPLUNGEN - RACORES-TOMAS GRIFO-ADAPTADORES-RACORES DE DISPARO-JUNTAS REPARADORAS

**RACCORDO 1/2" PORTAGOMMA A SCATTO ACQUASTOP**RACCORD 1/2" TUYAU A BRANCHEMENT AQUASTOP  
ACQUASTOP SNAP-FIT 1/2" HOSE ADAPTER  
STECKKUPPLUNG 1/2" FÜR SCHLAUCH MIT WASSERSTOPP  
RACOR 1/2" PORTAGOMA DE DISPARO AGUA STOP

| ARTICOLO     | DESCRIZIONE  |
|--------------|--|
| <b>27144</b> | Per tubi ø int. da 1/2" a 5/8" (da 12,5 a 15,5 mm) |

**RACCORDO 3/4" PORTAGOMMA A SCATTO ACQUASTOP**RACCORD 3/4" TUYAU A BRANCHEMENT AQUASTOP  
ACQUASTOP SNAP-FIT 3/4" HOSE ADAPTER  
STECKKUPPLUNG 3/4" FÜR SCHLAUCH MIT WASSERSTOPP  
RACOR 3/4" PORTAGOMA DE DISPARO AGUA STOP

| ARTICOLO     | DESCRIZIONE                                      |
|--------------|--|
| <b>27143</b> | Per tubi ø int. da 5/8" a 3/4" (da 15,5 a 19 mm) |

**RACCORDO UNIVERSALE PORTAGOMMA A SCATTO ACQUASTOP**RACCORD UNIVERSEL TUYAU A BRANCHEMENT AQUASTOP  
ACQUASTOP SNAP-FIT UNIVERSAL HOSE ADAPTER  
UNIVERSAL-STECKKUPPLUNG 1/2" FÜR SCHLAUCH MIT WASSERSTOPP  
RACOR UNIVERSAL PORTAGOMA DE DISPARO AGUA STOP

| ARTICOLO     | DESCRIZIONE  |
|--------------|--|
| <b>27145</b> | Per tubi con ø int. 1/2", 5/8", 3/4" (da 12,5 a 19 mm) |

**GIUNTO RIPARATORE**JOINT REPARATEUR  
REPAIR COLLAR  
REPARATURKUPPLUNG  
JUNTA REPARADORA

| ARTICOLO     | DESCRIZIONE                      |
|--------------|----------------------------------|
| <b>26971</b> | Per tubi con ø int. 3/4" (19 mm) |

**RACCORDO 3/4" PORTAGOMMA A SCATTO APERTO**RACCORD 3/4" TUYAU A BRANCHEMENT OUVERT  
OPEN SNAP-FIT 3/4" HOSE ADAPTER  
STECKKUPPLUNG 3/4" FÜR SCHLAUCH  
RACOR 3/4" PORTAGOMA DE DISPARO ABIERTO

| ARTICOLO     | DESCRIZIONE                  |
|--------------|------------------------------|
| <b>26968</b> | Per tubi ø int. 3/4" (19 mm) |

**RACCORDO UNIVERSALE PORTAGOMMA A SCATTO APERTO**RACCORD UNIVERSEL TUYAU A BRANCHEMENT OUVERT  
OPEN SNAP-FIT UNIVERSAL HOSE ADAPTER  
UNIVERSAL-STECKKUPPLUNG 1/2" FÜR SCHLAUCH  
RACOR UNIVERSAL PORTAGOMA DE DISPARO ABIERTO

| ARTICOLO     | DESCRIZIONE  |
|--------------|--|
| <b>26969</b> | Per tubi con ø int. 1/2", 5/8", 3/4" (da 12,5 a 19 mm) |

**GIUNTO RIPARATORE**JOINT REPARATEUR  
REPAIR COLLAR  
REPARATURKUPPLUNG  
JUNTA REPARADORA

| ARTICOLO     | DESCRIZIONE  |
|--------------|--|
| <b>26970</b> | Per tubi con ø int. da 1/2" a 5/8" (da 12,5 a 15,5 mm) |

**GIUNTO RIPARATORE UNIVERSALE**JOINT REPARATEUR UNIVERSEL  
UNIVERSAL REPAIR COLLAR  
UNIVERSAL-REPARATURKUPPLUNG  
JUNTA REPARADORA UNIVERSAL

| ARTICOLO     | DESCRIZIONE  |
|--------------|--|
| <b>26972</b> | Per tubi con ø int. 1/2", 5/8", 3/4" (da 12,5 a 19 mm) |

### segue RACCORDI - PRESE RUBINETTO - ADATTATORI - RACCORDI A SCATTO - GIUNTI RIPARATORI

RACCORDS-PRISES ROBINET-ADAPTATEURS-RACCORDS A BRANCHEMENT-JOINTS REPARATEURS - UNIONS-COCK CONNECTIONS-ADAPTERS-SNAP FITTINGS-REPAIR COLLARS - ANSCHLÜSSE-HAHNSTÜCKE-ADAPTER-STECKKUPPLUNGEN-REPARATURKUPPLUNGEN - RACORES-TOMAS GRIFO-ADAPTADORES-RACORES DE DISPARO-JUNTAS REPARADORAS

#### CONNETTORE 2 INNESTI

CONNECTEUR 2 VOIES  
2-WAY CONNECTOR  
SCHLAUCHKUPPLUNG-SCHLAUCHVERBINDER 2 STÜCK  
CONECTOR 2 ACOPLAMIENTOS



#### CONNETTORE 3 INNESTI

CONNECTEUR 3 VOIES  
3-WAY CONNECTOR  
SCHLAUCHKUPPLUNG-SCHLAUCHVERBINDER Y-STÜCK  
CONECTOR 3 ACOPLAMIENTOS



| ARTICOLO | DESCRIZIONE |
|----------|-------------|
| 26973    | -           |

| ARTICOLO | DESCRIZIONE |
|----------|-------------|
| 26974    | -           |

### LANCE

LANCES - SPRAY GUNS - SPRITZGIESSSTAB - LANZAS

#### DOCCETTA SU PROLUNGA

DOUCHE SUR RALLONGE  
SPRAY FITTING ON EXTENSION  
SPRITZBRAUSE  
DUCHA EN PROLONGACIÓN

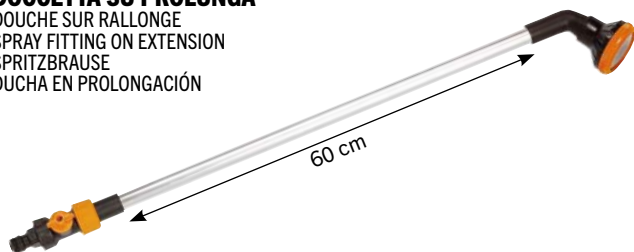

#### LANCIA A MEDIA PORTATA E DOPPIA REGOLAZIONE CON INSERTO IN GOMMA

LANCE A MOYENNE PORTEE ET DOUBLE REGLAGE AVEC INSERT EN CAOUTCHOUC  
MEDIUM-RANGE SPRAY GUN WITH DOUBLE SETTING AND RUBBER INSERT  
SPRITZGIESSSTAB MITTLERER DURCHSATZ UND DOPPELTE EINSTELLUNG MIT GUMMIEINSATZ  
LANZA DE ALCANCE MEDIO Y DOBLE REGULACIÓN CON INSERTO DE GOMA



| ARTICOLO | DESCRIZIONE                    |
|----------|--------------------------------|
| 27068    | Doccetta completa di rubinetto |

| ARTICOLO | DESCRIZIONE                |
|----------|----------------------------|
| 26980    | Erogazione fino a 20 l/min |

#### LANCIA A MEDIA PORTATA E DOPPIA REGOLAZIONE

LANCE A MOYENNE PORTEE ET DOUBLE REGLAGE  
MEDIUM-RANGE SPRAY GUN WITH DOUBLE SETTING  
SPRITZSTAB MIT MITTLEREM DURCHSATZ UND DOPPELTER EINSTELLUNG  
LANZA DE ALCANCE MEDIO Y DOBLE REGULACIÓN



#### KIT 4 PEZZI - LANCIA A MEDIA PORTATA E DOPPIA REGOLAZIONE

KIT 4 PIECES - LANCE A MOYENNE PORTEE ET DOUBLE REGLAGE  
4-PIECE KIT - MEDIUM-RANGE SPRAY GUN WITH DOUBLE SETTING  
SATZ 4 STÜCK - SPRITZSTAB MIT MITTLEREM DURCHSATZ UND DOPPELTER EINSTELLUNG  
KIT 4 PIEZAS - LANZA DE ALCANCE MEDIO Y DOBLE REGULACIÓN



| ARTICOLO | DESCRIZIONE                |
|----------|----------------------------|
| 26982    | Erogazione fino a 20 l/min |

| ARTICOLO |
|----------|
| 26983    |

#### LANCIA A SPRUZZO REGOLABILE MEDIA

LANCE A JET REGLABLE MOYEN  
MEDIUM-RANGE ADJUSTABLE SPRAY GUN  
SPRITZSTAB EINSTELLBAR MITTEL  
LANZA CON CHORRO REGULABLE MEDIA



#### LANCIA A SPRUZZO REGOLABILE

LANCE A JET REGLABLE  
ADJUSTABLE SPRAY GUN  
SPRITZSTAB EINSTELLBAR  
LANZA CON CHORRO REGULABLE



| ARTICOLO | DESCRIZIONE                   |
|----------|-------------------------------|
| 26984    | Portata max. 14 l/min a 3 bar |

| ARTICOLO | DESCRIZIONE                |
|----------|----------------------------|
| 26402    | Erogazione fino a 12 l/min |



## segue LANCE

LANCES - SPRAY GUNS - SPRITZGIESSSTAB - LANZAS

**KIT 2 PEZZI - LANCIA REGOLABILE 5/8"**

KIT 2 PIECES - LANCE REGLABLE 5/8"  
2-PIECE KIT - 5/8" ADJUSTABLE SPRAY GUN  
KIT 2 STÜCK - EINSTELLBARER SPRITZSTAB 5/8"  
KIT 2 PIEZAS - LANZA REGULABLE 5/8"



| ARTICOLO     | DESCRIZIONE  |
|--------------|--|
| <b>27146</b> | Acquastop per tubi ø int. da 1/2" a 5/8" (da 12,5 a 15,5 mm) |

**PISTOLE**

PISTOLET - SPRAY GUNS - SPRITZE - PISTOLAS

**PISTOLA PER IRRIGAZIONE**

PISTOLET D'ARROSAGE  
SPRINKLER GUN  
SPRITZE  
PISTOLA PARA RIEGO



| ARTICOLO     | DESCRIZIONE              |
|--------------|--------------------------|
| <b>26986</b> | Portata 10 l/min a 3 bar |

**PISTOLA PER IRRIGAZIONE MULTIGETTO 8 JET EASY**

PISTOLET D'ARROSAGE MULTIJET 8 JET EASY  
8 JET EASY MULTIPLE-JET SPRINKLER GUN  
8 JET EASY MEHRFACHSPRITZE  
PISTOLA PARA RIEGO MULTICHORRO 8 JET EASY

**CARATTERISTICHE**

Pistola compatta e versatile per l'irrigazione e la pulizia di qualsiasi superficie. Design semplice e funzionale per il massimo comfort di utilizzo.

- Regolatore-modulatore di portata per la regolazione progressiva del flusso d'acqua da chiuso a completamente aperto.
- Selettore "8 JET" a rotazione con possibilità di selezionare 8 getti diversi.



| ARTICOLO     | DESCRIZIONE              |
|--------------|--------------------------|
| <b>26987</b> | Portata 18 l/min a 4 bar |

**PISTOLA PER IRRIGAZIONE IN METALLO E GOMMA**

PISTOLET D'ARROSAGE EN MÉTAL ET CAOUTCHOUC  
SPRINKLER GUN IN METAL AND RUBBER  
SPRITZE AUS GUMMI UND METALL  
PISTOLA PARA RIEGO DE METAL Y GOMA



| ARTICOLO     | DESCRIZIONE              |
|--------------|--------------------------|
| <b>26988</b> | Portata 10 l/min a 3 bar |

**PISTOLA MULTIGETTO IN METALLO E GOMMA**

PISTOLET MULTIJET EN MÉTAL ET CAOUTCHOUC  
MULTIPLE-JET SPRINKLER GUN IN METAL AND RUBBER  
MEHRFACHSPRITZE AUS GUMMI UND METALL  
PISTOLA MULTICHORRO DE METAL Y GOMA



| ARTICOLO     | DESCRIZIONE              |
|--------------|--------------------------|
| <b>26989</b> | Portata 10 l/min a 3 bar |

### IRRORATORI

PULVÉRISATEURS – SPRAYERS – REGNER - PULVERIZADORES

#### 4 JET - IRRORATORE CIRCOLARE E A SETTORE CON MOVIMENTO TURBINA

4 JET - ARROSEUR CIRCULAIRE ET PAR SECTEUR AVEC MOUVEMENT A TURBINE  
4-JET REVOLVING AND SECTOR CROP DUSTER WITH TURBINE MOVEMENT  
4 JET - KREIS- UND SEKTORENREGNER MIT TURBINENBEWEGUNG  
4 JET - ASPERSOR CIRCULAR Y DE SECTOR CON MOVIMIENTO TURBINA



#### CARATTERISTICHE

Superficie max irrorata: 380 m3 (ø 22 mm).  
Angolo di irrigazione da 15° a 360°.

ARTICOLO  
**26990**

#### ROTAX - IRRORATORE ROTANTE A DUE BRACCIA SU BASE

ROTAX - ARROSEUR ROTATIF A DEUX BRAS SUR EMBASE  
ROTAX - REVOLVING CROP DUSTER WITH TWO ARMS ON BASE  
ROTAX - DREHREGLER MIT 2 ARMEN AUF UNTERGESTELL  
ROTAX - ASPERSOR ROTATIVO DE DOS BRAZOS SOBRE BASE



#### CARATTERISTICHE

Ideale per innaffiare superfici medio-piccole.

- Ugelli regolabili per ottimizzare l'irrigazione in funzione della tipologia di piante da irrigare.
- Portata massima 19 l/min.
- Pressione 2÷4 bar.

ARTICOLO  
**26992**

#### IRRORATORE OSCILLANTE A REGOLAZIONE CONTINUA

ARROSEUR OSCILLANT A REGLAGE CONTINU  
OSCILLATING CROP DUSTER WITH CONTINUOUS REGULATION  
PENDELREGNER MIT DURCHGEHENDER EINSTELLUNG  
ASPERSOR OSCILANTE CON REGULACIÓN CONTINUA



#### CARATTERISTICHE

Superficie max irrorata: 220 m3 (13x17).  
Arco di irrorazione da 20° a 100°.

ARTICOLO  
**27152**

#### DRIVER - IRRORATORE MULTIFUNZIONE SU BASE

DRIVER - ARROSEUR MULTIFONCTION SUR EMBASE  
DRIVER - ALL-PURPOSE CROP DUSTER ON BASE  
DRIVER - MULTIFUNKTIONSREGNER AUF UNTERGESTELL  
DRIVER - ASPERSOR MULTIFUNCIÓN SOBRE BASE



#### CARATTERISTICHE

- Con la semplice rotazione del disco si possono irrorare 8 diverse aree.
- Portata massima 18 l/min.
- Raggio d'azione 12 m.
- Angolo d'irrigazione 15°÷360°.
- Pressione 2÷4 bar.

ARTICOLO  
**26991**

#### IRRORATORE PULSANTE SPIT1 A SETTORE, VERSIONE SU PUNTALE

ARROSEUR BOUTON SPIT1 PAR SECTEUR, VERSION SUR PIONTEAU  
SPIT1 SECTOR IMPULSE CROP DUSTER, VERSION ON ROD  
SPIT1 IMPULS-SEKTORENREGNER, VERSION AUF SPIKE  
ASPERSOR PULSADOR DE SECTOR SPIT1, VERSIÓN CON COLUMNNA



#### CARATTERISTICHE

Ideale per le grandi superfici.

- Dispositivo rompigetto per la distribuzione uniforme dell'acqua.
- Angolo di irrigazione da 15° a 360°.
- Portata massima 15 l/min.
- Raggio d'azione 12 m.
- Pressione 2÷4 bar.

ARTICOLO  
**27151**

**RACCORDI E LANCE GRANDE PORTATA**

RACCORDS LANCE JET GRANDE PORTEE - HIGH FLOW UNIONS AND SPRAY GUNS - ANSCHLÜSSE UND SPRITZSTAB FÜR GROSSE WASSERMENGEN - RACORES Y LANZAS DE ELEVADO ALCANCE

**RACCORDO PORTAGOMMA A SCATTO GRANDE PORTATA**

RACCORD POUR TUYAU RAPIDE GRANDE PORTEE  
HIGH FLOW SNAP-FIT HOSE ADAPTER  
SCHLAUCHVERBINDUNG - STECKKUPPLUNG FÜR GROSSE WASSERMENGEN  
RACOR PORTAGOMA DE DISPARO DE ELEVADO ALCANCE



| ARTICOLO     | DESCRIZIONE                 | ARTICOLO     | DESCRIZIONE                 |
|--------------|-----------------------------|--------------|-----------------------------|
| <b>26975</b> | Per tubi ø int. 1" (25,4mm) | <b>26976</b> | Per tubi ø int. 3/4" (19mm) |

**GIUNTO RIPARATORE GRANDE PORTATA**

JOINT REPARATEUR GRANDE PORTEE  
HIGH FLOW REPAIR COLLAR  
REPARATOR FÜR GROSSE WASSERMENGEN  
JUNTA REPARADORA ELEVADO ALCANCE



| ARTICOLO     | DESCRIZIONE                 | ARTICOLO     | DESCRIZIONE                 |
|--------------|-----------------------------|--------------|-----------------------------|
| <b>26977</b> | Per tubi ø int. 1" (25,4mm) | <b>26978</b> | Per tubi ø int. 3/4" (19mm) |

**LANCIA SPRUZZO GRANDE PORTATA**

LANCE JET GRANDE PORTEE  
HIGH FLOW SPRAY GUN  
SPRITZSTAB FÜR GROSSE WASSERMENGEN  
LANZA ATOMIZACIÓN ELEVADO ALCANCE



| ARTICOLO     | DESCRIZIONE                   |
|--------------|-------------------------------|
| <b>26979</b> | Portata max. 40 l/min a 3 bar |

**PRESA GRANDE PORTATA PER RUBINETTO FILETTATO 1"**

PRISE GRANDE PORTEE POUR ROBINET FILETE 1"  
1" HIGH FLOW CONNECTION FOR THREADED COCKS  
HAHNSTÜCK MIT GEWINDE FÜR GROSSE WASSERMENGEN 1"  
TOMA ELEVADO ALCANCE PARA GRIFO ROSCADO 1"



| ARTICOLO     | DESCRIZIONE         |
|--------------|---------------------|
| <b>27067</b> | Dotata di riduzione |

**PROGRAMMATORI**

ELECTRONIC PROGRAMMERS FOR IRRIGATION

**PROGRAMMATORE ELETTRONICO DI IRRIGAZIONE A BATTERIA. GF48 - 48 PROGRAMMI SELEZIONABILI**

GF48 - PROGRAMMATEUR ELECTRONIQUE D'ARROSAGE A BATTERIE. 48 PROGRAMMES SELECTIONNABLES  
GF48 - BATTERY OPERATED ELECTRONIC SPRINKLER PROGRAMMER 48 PROGRAMS AVAILABLE  
GF48 - ELEKTRONISCHE BEWÄSSERUNGSSTEUERUNG MIT BATTERIE. 48 PROGRAMME WÄHLBAR  
GF48 - PROGRAMADOR ELECTRÓNICO DE RIEGO CON BATERÍA. 48 PROGRAMAS SELECCIONABLES



| ARTICOLO     | PORTATA MASSIMA DI UTILIZZO | ATTACCO RUBINETTO |
|--------------|-----------------------------|-------------------|
| <b>26994</b> | 8 bar                       | 3/4"              |

**PROGRAMMATORE ELETTRONICO DI IRRIGAZIONE A BATTERIA GF16 - 16 PROGRAMMI SELEZIONABILI**

GF16 - PROGRAMMATEUR ELECTRONIQUE D'ARROSAGE A BATTERIE. 16 PROGRAMMES SELECTIONNABLES  
GF16 - BATTERY OPERATED ELECTRONIC SPRINKLER PROGRAMMER 16 PROGRAMS AVAILABLE  
GF16 - ELEKTRONISCHE BEWÄSSERUNGSSTEUERUNG MIT BATTERIE. 16 PROGRAMME WÄHLBAR  
GF16 - PROGRAMADOR ELECTRÓNICO DE RIEGO CON BATERÍA. 16 PROGRAMAS SELECCIONABLES



| ARTICOLO     | PORTATA MASSIMA DI UTILIZZO | ATTACCO RUBINETTO |
|--------------|-----------------------------|-------------------|
| <b>26995</b> | 8 bar                       | 3/4"              |

### AVVOLGITUBO PER GIARDINAGGIO

ENROULER TUYAU ARROSAGE JARDIN - GARDEN HOSE REEL - ROHRWICKLER FÜR GARTEN - ENROLLADOR DE TUBOS

#### EUROTANK - CARRELLO AVVOLGITUBO

EUROTANK - CHARIOT DEVIDOIR  
EUROTANK - GARDEN HOSE REEL  
EUROTANK - SCHLAUCHTROMMEL  
EUROTANK - CARRO ENROLLADOR DE TUBOS



| ARTICOLO     | CARATTERISTICHE                          |
|--------------|--|
| <b>26997</b> | Può portare fino a 60 m di tubo da 1/2". |

#### REELY 40

REELY 40  
REELY 40  
REELY 40  
REELY 40



| ARTICOLO     | CARATTERISTICHE                          |
|--------------|--|
| <b>26999</b> | Può portare fino a 40 m di tubo da 1/2". |

#### CARRELLO AVVOLGITUBO PROFESSIONAL

CHARIOT DEVIDOIR PROFESSIONNEL  
PROFESSIONAL HOSE REEL  
PROFESSIONELLE SCHLAUCHTROMMEL  
CARRO ENROLLADOR DE TUBOS PROFESIONAL



| ARTICOLO     | CARATTERISTICHE   |
|--------------|---|
| <b>25852</b> | Raccordi in ottone per tubo Ø 19<br>Può portare fino a 100 m di tubo. |

#### BABY PLUS - AVVOLGITUBO PORTATILE COMPLETO DI TUBO ED ACCESSORI, MONTATO.

BABY PLUS - DEVIDOIR PORTATIF AVEC TUYAU ET ACCESSOIRES, MONTÉ.  
BABY PLUS - PORTABLE HOSE REEL COMPLETE WITH HOSE AND ACCESSORIES, ASSEMBLED.  
BABY PLUS - TRAGBARE SCHLAUCHTROMMEL MIT SCHLAUCH UND ZUBEHÖRTEILEN, MONTIERT.  
BABY PLUS - ENROLLADOR DE TUBOS PORTÁTIL; INCLUYE CON TUBO Y ACCESORIOS MONTADOS.



| ARTICOLO     | CARATTERISTICHE                          |
|--------------|--|
| <b>27000</b> | Può portare fino a 15 m di tubo da 1/2". |

### TUBO MULTISTRATO FLESSIBILE, USO DOMESTICO - MIMOSE

TUBE MULTICOUCHE FLEXIBLE, USAGE DOMESTIQUE - MIMOSE  
 MULTILAYER HOSE, HOUSEHOLD USE - MIMOSE  
 FLEXIBLER MEHRLAGIGER SCHLAUCH, FÜR HAUSHALT - MIMOSE  
 TUBO MULTICAPA FLEXIBLE, USO DOMÉSTICO - MIMOSE



- 1 Rivestimento in PVC flessibile
- 2 Strato intermedio giallo espanso
- 3 Rinforzo tessile magliato
- 4 Strato intermedio giallo espanso
- 5 Anima bistrato liscia in PVC flessibile

#### USO E CARATTERISTICHE

**USO:** trasporto acqua e innaffiatura - uso domestico regolare.

**CARATTERISTICHE:** Manichetta magliato 5 strati con struttura "alveare", leggero e flessibile. - Temperatura — 15°C +60°C.

| ARTICOLO<br>rotolo 15 m | ARTICOLO<br>rotolo 25 m | ARTICOLO<br>rotolo 50 m | Ø INT.<br>mm | SPESS. PARETE<br>mm | PESO<br>g/m | PRESSIONE<br>ESERCIZIO bar |
|-------------------------|-------------------------|-------------------------|--------------|---------------------|-------------|----------------------------|
| 27417                   | 27414                   | 25406                   | 12,5         | 2,25                | 160         | 8                          |
| 27419                   | 27415                   | 25407                   | 15,0         | 2,05                | 200         | 8                          |
| -                       | 27416                   | 25408                   | 19,0         | 2,40                | 290         | 6                          |
| -                       | -                       | 25410                   | 25,0         | 3,00                | 440         | 6                          |
| -                       | -                       | 25411                   | 30,0         | 4,20                | 520         | 6                          |

### TUBO PER GIARDINAGGIO 5 STRATI - NTS YELLOW

TUYAU POUR JARDINAGE 5 COUCHES - NTS YELLOW  
 5-PLY GARDENING HOSE - NTS YELLOW  
 GARTENSCHLAUCH 5 LAGEN - NTS YELLOW  
 TUBO PARA JARDINERÍA 5 CAPAS - NTS YELLOW



- 1 Rivestimento in PVC flessibile
- 2 Strato intermedio giallo espanso
- 3 Rinforzo tessile magliato
- 4 Strato intermedio giallo espanso
- 5 Anima nera liscia in PVC flessibile

#### USO E CARATTERISTICHE

**USO:** trasporto acqua, innaffiatura e irrigazione.

**CARATTERISTICHE:** Manichetta magliato 5 strati con struttura "alveare", leggero e flessibile. - Temperatura — 15°C +60°C.

| ARTICOLO<br>rotolo 25 m | ARTICOLO<br>rotolo 50 m | Ø INTERNO<br>mm | SPESS. PARETE<br>mm | PRESSIONE<br>ESERCIZIO bar |
|-------------------------|-------------------------|-----------------|---------------------|----------------------------|
| 27418                   | 26740                   | 12,5            | 2,25                | 9                          |
| 27420                   | 26741                   | 15,0            | 2,25                | 9                          |
| 27421                   | 26742                   | 19,0            | 2,75                | 8                          |
| -                       | 26743                   | 25,0            | -                   | -                          |

### KIT 10 M DI TUBO A SPIRALE ESTENSIBILE CON ACCESSORI IN BLISTER

KIT 10 m DE TUYAU A SPIRALE EXTENSIBLE AVEC ACCESSOIRES SOUS BLISTER  
 KIT WITH 10 m EXTENSIBLE SPIRAL HOSE WITH ACCESSORIES IN BLISTER-PACK  
 KIT 10 m DEHNBARER SPIRALSCHLAUCH MIT ZUBEHÖRTEILEN IM BLISTER  
 KIT 10 m DE TUBO ESPIRALADO EXTENSIBLE CON ACCESORIOS EN BLISTER



ARTICOLO  
**27003**

### PORTATUBO DA PARETE

PORTE-TUYAU MURAL  
 HOSE HOLDER WALL-MOUNT  
 SCHLAUCHTROMMEL FÜR WANDMONTAGE  
 PORTATUBO DE PARED



ARTICOLO  
**27002**

### SACK TROLLEY - CARRELLO RACCOGLI ERBA E FOGLIE

SACK TROLLEY - CHARIOT RAMASSAGE HERBE ET FEUILLES  
 SACK TROLLEY FOR GRASS AND LEAVES  
 SACK TROLLEY – GRAS- UND LAUBSAMMELWAGEN  
 SACK TROLLEY - CARRO PARA LA RECOGIDA DE HIERBAS Y HOJAS



ARTICOLO  
**27001**

### LAVABOTTIGLIE IDRAULICO

LAVE-BOUITEILLES HYDRAULIQUE  
 HYDRAULIC BOTTLE WASHER  
 HYDRAULISCHE FLASCHENWASCHANLAGE  
 LAVA-BOTELLAS HIDRÁULICO



ARTICOLO  
**27004**

### IDROPULTRICI AD ACQUA FREDDA E CALDA

NETTOYEURS HAUTE PRESSION A EAU FROIDE ET CHAUDE - HOT AND COLD WATER HIGH PRESSURE CLEANERS  
HOCHDRUCKREINIGER KALT- UND WARMWASSER - HIDROLAVADORA DE AGUA FRÍA Y CALIENTE

#### IDROPULTRICE KRS EXTRA ACQUA FREDDA (HOBBYSTICA)

NETTOYEUR KRS EXTRA EAU FROIDE (bricolage)  
KRS EXTRA COLD WATER HIGH PRESSURE CLEANER (D.I.Y.)  
HOCHDRUCKREINIGER KRS EXTRA KALTWASSER (Hobbyzwecke)  
HIDROLAVADORA KRS EXTRA AGUA FRÍA (estándar)



#### CARATTERISTICHE

- Idropultrice ad acqua fredda con motore elettrico.
- Motore universale ad alta efficienza con protezione termica.
- Pompa assiale a tre pistoni con testata in alluminio.
- Maniglia ergonomica con alloggiamento per pistola e lancia.
- Dispositivo TotalStop.
- Ruote in plastica Ø 17,5 cm con rivestimento in gomma.
- Serbatoio detergente integrato.
- Avvolgitubo nella parte superiore.
- Uso domestico.

| ARTICOLO     | PORTATA<br>MAX<br>l/h | PRESSIONE<br>MAX<br>bar | TENSIONE<br>V | POTENZA<br>ASSORBITA<br>kW | SERBATOIO<br>l | PESO<br>kg | DIMENSIONE<br>cm |
|--------------|-----------------------|-------------------------|---------------|----------------------------|----------------|------------|------------------|
| <b>26883</b> | 500                   | 150                     | 230           | 2,35                       | 0,7            | 8,6        | 33x28x84         |

NB: Testata pompa in alluminio.

#### IDROPULTRICE KLS1600 GOLD EXTRA ACQUA FREDDA (SEMI PROFESSIONALE)

NETTOYEUR KLS1600 GOLD EXTRA EAU FROIDE (semi professionnel)  
KLS1600 GOLD EXTRA COLD WATER HIGH PRESSURE CLEANER (semi-professional)  
HOCHDRUCKREINIGER KLS1600 GOLD EXTRA KALTWASSER (semiprofessionell)  
HIDROLAVADORA KLS1600 GOLD EXTRA AGUA FRÍA (semiprofesional)



#### CARATTERISTICHE

- Struttura a sviluppo verticale concepita per la massima ergonomia e praticità d'uso
- Pompa a tre pistoni assiali disposta in verticale con pompa in basso e costruzione interamente in metallo, senza materiale plastico nei componenti strutturali
- Motore elettrico a induzione con protezione termica
- Testata pompa in ottone
- Dispositivo EASY START
- Dispositivo Total Stop
- Serbatoio detergente integrato facilmente removibile
- Filtro aspirazione con attacco rapido
- Avvolgitubo in pressione

| ARTICOLO     | PORTATA<br>MAX<br>l/h | PRESSIONE<br>MAX<br>bar | TENSIONE<br>V | POTENZA<br>ASSORBITA<br>kW | giri/min | PESO<br>kg | DIMENSIONE<br>cm |
|--------------|-----------------------|-------------------------|---------------|----------------------------|----------|------------|------------------|
| <b>26884</b> | 450                   | 150                     | 230           | 2,2                        | 2800     | 14,5       | 28x28x88         |

NB: Testata pompa in ottone.

## segue IDROPULTRICI AD ACQUA FREDDA E CALDA

NETTOYEURS HAUTE PRESSION A EAU FROIDE ET CHAUDE - HOT AND COLD WATER HIGH PRESSURE CLEANERS  
HOCHDRUCKREINIGER KALT- UND WARMWASSER - HIDROLAVADORA DE AGUA FRÍA Y CALIENTE

### IDROPULTRICE KS1700 EXTRA GOLD ACQUA FREDDA (SEMI PROFESSIONALE)

NETTOYEUR KS1700 EXTRA GOLD EAU FROIDE (semi professionnel)  
KL1700 EXTRA GOLD COLD WATER HIGH PRESSURE CLEANER (semi-professional)  
HOCHDRUCKREINIGER KL1700 EXTRA GOLD KALTWASSER (semiprofessionell)  
HIDROLAVADORA KL1700 EXTRA GOLD AGUA FRÍA (semiprofesional)



#### CARATTERISTICHE

- Pompa a tre pistoni con testata in ottone, flangiata direttamente al motore elettrico.
- Dispositivo TOTAL-STOP che ferma il motore alla chiusura della lancia, garantendo il risparmio di energia.
- Dispositivo EASY-START, che garantisce la partenza sicura del motore in ogni condizione di allacciamento elettrico.
- Motoprotettore amperometrico a riarmo manuale.
- Aspirazione del detergente diretta da serbatoio capacità 1,8 lt.
- Pistola di tipo professionale.
- Lancia curva in acciaio a getto regolabile.
- Tubo alta pressione in gomma (10mt).
- Avvolgitubo girevole.
- Attacco rapido aspirazione acqua.
- Lancia con ugello rotante.

| ARTICOLO     | PORTATA<br>MAX<br>l/h | PRESSIONE<br>MAX<br>bar | TENSIONE<br>V | POTENZA<br>ASSORBITA<br>kW | giri/min | PESO<br>kg | DIMENSIONE<br>cm |
|--------------|-----------------------|-------------------------|---------------|----------------------------|----------|------------|------------------|
| <b>26885</b> | 540                   | 155                     | 230           | 2,7                        | 2800     | 19         | 89x32x38         |

NB: Testata pompa in ottone.

### IDROPULTRICE KT1800 EXTRA GOLD ACQUA FREDDA (SEMI PROFESSIONALE)

NETTOYEUR KT1800 EXTRA GOLD EAU FROIDE (semi professionnel)  
KT1800 EXTRA GOLD COLD WATER HIGH PRESSURE CLEANER (semi-professional)  
HOCHDRUCKREINIGER KT1800 EXTRA GOLD KALTWASSER (semiprofessionell)  
HIDROLAVADORA KT1800 EXTRA GOLD AGUA FRÍA (semiprofesional)



#### CARATTERISTICHE

- Avvolgitubo collocato nella parte inferiore della idropultrice con garanzia di eccezionale stabilità della macchina anche durante il lavoro.
- Aspirazione detergente in bassa pressione dal serbatoio interno.
- Vano posteriore per collocare il cavo elettrico.
- Elettropompa Comet a tre pistoni assiali disposta in verticale con pompa in basso e costruzione interamente in metallo, senza materiale plastico nei componenti strutturali.
- Pompa con testata in ottone.
- Dispositivo EASY-START.
- Dispositivo TotalStop.
- Protezione termica motore.
- Pistola tipo professionale.
- Lancia curva in acciaio a getto regolabile.
- Lancia angolata con ugello rotante.
- Idropazzola fissa.
- Kit tubo mandata 12m (su avvolgitubo).

| ARTICOLO     | PORTATA<br>MAX<br>l/h | PRESSIONE<br>MAX<br>bar | TENSIONE<br>V | POTENZA<br>ASSORBITA<br>kW | PESO<br>kg | DIMENSIONE<br>cm |
|--------------|-----------------------|-------------------------|---------------|----------------------------|------------|------------------|
| <b>27569</b> | 550                   | 160                     | 230           | 2,7                        | 25         | 40x41x91         |

### segue IDROPULTRICI AD ACQUA FREDDA E CALDA

NETTOYEURS HAUTE PRESSION A EAU FROIDE ET CHAUDE - HOT AND COLD WATER HIGH PRESSURE CLEANERS  
HOCHDRUCKREINIGER KALT- UND WARMWASSER - HIDROLAVADORA DE AGUA FRÍA Y CALIENTE

#### IDROPULTRICE NEW SCOUT 150 CLASSIC ACQUA CALDA (SEMI PROFESSIONALE)

NETTOYEUR NEW SCOUT 150 CLASSIC EAU CHAUDE (semi professionnel)  
NEW SCOUT 150 HOT WATER HIGH PRESSURE CLEANER (semi-professional)  
HOCHDRUCKREINIGER NEW SCOUT 150 CLASSIC WARMWASSER (semiprofessionell)  
HIDROLAVADORA NEW SCOUT 150 CLASSIC AGUA CALIENTE (semiprofesional)



#### CARATTERISTICHE

- Elettropompa Comet a tre pistoni assiali disposta in orizzontale con pompa in basso e costruzione interamente in metallo, senza materiale plastico nei componenti strutturali e testata in ottone
- Manometro
- Serbatoio detergente integrato (3,5 lt)
- Aspirazione acqua diretta con detergente in bassa pressione
- Dispositivo EASY START
- Dispositivo Total Stop
- Partenza ritardata del bruciatore
- Valvola di sicurezza
- Protezione amperometrica del motore
- Termostato di regolazione temperatura
- Uso semiprofessionale



| ARTICOLO     | PORTATA MAX l/h | PRESSIONE MAX bar | TENSIONE V | POTENZA ASSORBITA kW | giri/min | TEMP. MAX USCITA ACQUA °C | PESO kg | DIMENSIONE cm |
|--------------|-----------------|-------------------|------------|----------------------|----------|---------------------------|---------|---------------|
| <b>26886</b> | 540             | 135               | 230        | 2,7                  | 2800     | 90                        | 66      | 89x59x84      |

NB: Testata pompa in ottone.

#### IDROPULTRICE KP CLASSIC 3.10 ACQUA CALDA (SEMI PROFESSIONALE)

NETTOYEUR KP CLASSIC 3.10 EAU CHAUDE (semi professionnel)  
KP CLASSIC 3.10 HOT WATER HIGH PRESSURE CLEANER (semi-professional)  
HOCHDRUCKREINIGER KP CLASSIC 3.10 WARMWASSER (semiprofessionell)  
HIDROLAVADORAS KP CLASSIC 3.10 AGUA CALIENTE (semiprofesional)



#### CARATTERISTICHE

- Serbatoio gasolio di capacità 15 litri, con galleggiante di livello e filtro di riempimento
- Aspirazione detergente in bassa pressione con regolazione
- Motore con protezione termica a 2 poli (2800 rpm)
- TotalStop temporizzato (istantaneo su modello KP 3.10)
- EASY-START su modelli monofase
- Valvola di sicurezza di protezione della caldaia
- Protezione termica della caldaia
- Interruttore rotativo per accensione
- Termostato di regolazione temperatura
- Controllo amperometrico (su modelli trifase)
- Controllo rotazione motore (su modelli trifase)
- Controllo fase (su modelli trifase)
- Spia "Mancanza gasolio"
- Uso semi-professionale gravoso



| ARTICOLO     | PORTATA MAX l/h | PRESSIONE MAX bar | TENSIONE V | POTENZA ASSORBITA kW | giri/min | TEMP. MAX USCITA ACQUA °C | PESO kg | DIMENSIONE cm |
|--------------|-----------------|-------------------|------------|----------------------|----------|---------------------------|---------|---------------|
| <b>27233</b> | 600             | 140               | 230        | 2,2                  | 2800     | 110                       | 95      | 94x62x84      |



## segue IDROPULITRICI AD ACQUA FREDDA E CALDA

NETTOYEURS HAUTE PRESSION A EAU FROIDE ET CHAUDE - HOT AND COLD WATER HIGH PRESSURE CLEANERS  
HOCHDRUCKREINIGER KALT- UND WARMWASSER - HIDROLAVADORA DE AGUA FRÍA Y CALIENTE

### IDROPULTRICE KM CLASSIC 6.15 ACQUA CALDA (PROFESSIONALE)

NETTOYEUR KM CLASSIC 6.15 EAU CHAUDE (professionnel)  
KM CLASSIC 6.15 HOT WATER HIGH PRESSURE CLEANER (professional)  
HOCHDRUCKREINIGER KM CLASSIC 6.15 WARMWASSER (professionell)  
HIDROLAVADORA KM CLASSIC 6.15 AGUA CALIENTE (profesional)



#### CARATTERISTICHE

- Serbatoio gasolio di capacità 18 litri, con galleggiante di livello e filtro riempimento.
- Aspirazione detergente in alta pressione con regolazione.
- Motore a 4 poli (1400 giri/minuto) pompe ZW con vaschetta acqua.
- TOTAL STOP temporizzato.
- Partenza ritardata del bruciatore.
- Valvola di sicurezza professionale.
- Protezione termica della caldaia.
- Interruttore Rotativo per accensione.
- Teleruttore e protezione del motore con controllo amperometrico.
- Termostato di regolazione temperatura.
- Spia "Mancanza gasolio".
- Spia "Macchina sottotensione".
- Spia "Controllo fase".
- Uso professionale continuo.
- Con vaschetta anticalcare.

#### DOTAZIONE

- Pistola girevole.
- Lancia angolata con testa portaugello.
- Ugello con getto a lama 25° attacco 1/4" MEG.
- Kit tubo gomma mandata SAE 100 - 10 m.



NB: Testata pompa in ottone.

| ARTICOLO     | PORTATA<br>MAX<br>l/h | PRESSIONE<br>MAX<br>bar | TENSIONE<br>V | POTENZA<br>MOTORE<br>HP | POTENZA<br>ASSORBITA<br>kW | giri/min | TEMP. MAX<br>USCITA ACQUA<br>°C | PESO<br>kg | DIMENSIONE<br>cm |
|--------------|-----------------------|-------------------------|---------------|-------------------------|----------------------------|----------|---------------------------------|------------|------------------|
| <b>27465</b> | 900                   | 160                     | 400           | 5,5                     | 4,8                        | 1400     | 110                             | 120        | 95x62x85         |

### IDROPULTRICE KF CLASSIC ACQUA CALDA (PROFESSIONALE)

NETTOYEUR KF CLASSIC EAU CHAUDE (professionnel)  
KF CLASSIC HOT WATER HIGH PRESSURE CLEANER (professional)  
HOCHDRUCKREINIGER KF CLASSIC WARMWASSER (professionell)  
HIDROLAVADORA KF CLASSIC AGUA CALIENTE (profesional)



#### CARATTERISTICHE

- Serbatoio gasolio con galleggiante livello e filtro di riempimento
- Aspirazione detergente in alta pressione con regolazione
- Aspirazione detergente in bassa pressione con regolazione
- Filtro aspirazione ispezionabile
- Motore a 4 poli professionale (1400 giri/min)
- Valvola regolazione pressione professionale
- TotalStop temporizzato
- Manometro pressione
- Valvola di sicurezza
- Protezione termica della caldaia
- Partenza ritardata del bruciatore
- Quadro comandi in bassa tensione
- Teleruttore
- Protezione del motore con relè termico
- Interruttore Rotativo per accensione
- Termostato di regolazione temperatura
- Spia "Mancanza gasolio"
- Spia "Macchina sottotensione"
- Uso professionale intensivo
- Con vaschetta anticalcare.

#### DOTAZIONE

- Pistola girevole.
- Lancia angolata con testa portaugello.
- Ugello con getto a lama 25° attacco 1/4" MEG.
- Kit tubo gomma mandata SAE 100 - 10 m.



NB: Testata pompa in ottone.

| ARTICOLO     | PORTATA<br>MAX<br>l/h | PRESSIONE<br>MAX<br>bar | TENSIONE<br>V | POTENZA<br>ASSORBITA<br>kW | SERBATOIO<br>l | TEMP. MAX<br>USCITA ACQUA<br>°C | PESO<br>kg | DIMENSIONE<br>cm |
|--------------|-----------------------|-------------------------|---------------|----------------------------|----------------|---------------------------------|------------|------------------|
| <b>27235</b> | 960                   | 210                     | 400           | 6,6                        | 16             | 110                             | 152        | 132x82x86        |

## IDROPULTRICI ACQUA FREDDA ANNOVI E REVERBERI

NETTOYEURS A EAU FROIDE - COLD WATER CLEANERS  
HOCHDRUCKREINIGER WARMWASSER - HIDROLAVADORA DE AGUA FRÍA

### IDROPULTRICE 164K X-TRA (HOBBYSTICA)

NETTOYEUR 164K X-TRA  
164K X-TRA CLEANER  
HOCHDRUCKREINIGER 164K X-TRA  
HIDROLAVADORA 164K X-TRA

**TSS®**  
Total Stop  
SYSTEM

new



Acqua fredda  
Cold water



Per uso saltuario  
For occasional usage



Lancia getto rotante  
Rotary lance

#### RICAMBI

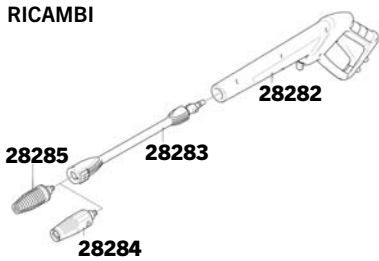

- Carrello a 2 ruote completo di manico
- Pompa a 3 pistoni assiali comandati dal piattello oscillante, testa alluminio
- Pistoni in acciaio inox temperato
- Valvola di sicurezza automatica con azzeramento della pressione nella testa pompa
- Sistema di arresto totale dell'idropultrice a distanza
- Protezione termica del motore
- Filtro acqua ispezionabile
- Lunghezza cavo elettrico 5 m
- Kit schiumogeno con serbatoio da 1 l.

- Two-wheel trolley with handle
- 3 Axial stainless steel pistons wobble-plate pump with aluminium head
- Tempered stainless steel pistons
- Automatic by-pass valve with pump head pressure discharge
- Remote control for total shut-down of high pressure washer
- Motor thermal protector
- Inspectable water filter
- Electric cable length 5 m
- Foam lance bottle capacity 1 l.

Elettropompa con pompa con testa in alluminio e motore con protezione termica

Electric motorpump with aluminium head pump and electric motor with thermal protector



Avvolgitubo statico  
Static hose reel



Porta accessori  
Accessories holder



Battistrada in gomma  
Rubber wheels



Filtro acqua ispezionabile  
Inspectable water filter

#### ACCESSORI IN DOTAZIONE

|                  |                               |                 |                             |                          |            |
|------------------|-------------------------------|-----------------|-----------------------------|--------------------------|------------|
|                  |                               |                 |                             |                          |            |
| TUBO AP<br>5,5 m | PISTOLA CON<br>ATTACCO RAPIDO | PROLUNGA LANCIA | TESTINA GETTO<br>REGOLABILE | TESTINA GETTO<br>ROTANTE | MINI PATIO |

| ARTICOLO | DESCRIZIONE  |
|----------|--|
| 27457    | Idropultrice monofase a freddo 440 l/h 130 bar - con carrello a 2 ruote, pompa a piattello e avvolgitubo |

### IDROPULTRICE DTS 5K TWIN FLOW (HOBBYSTICA)

NETTOYEUR DTS 5K TWIN FLOW  
DTS 5K TWIN FLOW CLEANER  
HOCHDRUCKREINIGER DTS 5K TWIN FLOW  
HIDROLAVADORA DTS 5K TWIN FLOW



new



- Manico telescopico con avvolgitubo in pressione (tubo AP 8m)
- 2 Pompe a 3 pistoni assiali comandati dal piattello oscillante, testa in alluminio
- Pistoni in acciaio inox temperato
- Valvola di sicurezza automatica con azzeramento della pressione nella testa pompa
- Doppio motore universale con protezione termica
- Lunghezza cavo elettrico 5m
- Sistema twin nozzle con doppio ugello rotante
- Ugello multi funzione 5 in 1.

- Two-wheel trolley with handle and in-pressure hose reel (8m HP hose)
- Two 3 Axial stainless steel pistons wobble-plate pumps
- Tempered stainless steel pistons
- Automatic by-pass valve with pump head pressure discharge
- Twin single-phase universal motor with thermal protector
- Electric cable length 5m
- Twin nozzle system with double rotary nozzle
- Multifunction 5 in 1 nozzle.

#### ACCESSORI IN DOTAZIONE



| ARTICOLO | DESCRIZIONE   |
|----------|---|
| 28315    | Idropultrice monofase a freddo 850 l/h - 160 bar con carrello a 2 ruote, doppia pompa a piattello e accessori |



**ANNOVI  
REVERBERI**  
The Power of Experience

# Idropulitrici WATER CLEANERS

16

## segue IDROPULITRICI ACQUA FREDDA ANNOVI E REVERBERI

NETTOYEURS A EAU FROIDE - COLD WATER CLEANERS

HOCHDRUCKREINIGER WARMWASSER - HIDROLAVADORA DE AGUA FRÍA

### IDROPULTRICE VIP REVO 613K (PROFESSIONALE)

NETTOYEUR VIP REVO 613K  
VIP REVO 613K CLEANER  
HOCHDRUCKREINIGER VIP REVO 613K  
HIDROLAVADORA VIP REVO 613K

**TSS**  
Total Stop  
SYSTEM

new



Acqua fredda  
Cold water



Per uso professionale  
For professional usage



Accessori professionali  
Professional accessories



- Pompa a 3 pistoni in ceramica, con sistema biellamanovella
- Valvola di sicurezza automatica con azzeramento della pressione nella testa pompa
- Testa pompa in ottone
- Protezione termica del motore
- Regolazione della pressione
- Manometro
- Aspirazione detergente
- Filtro acqua ispezionabile
- Lunghezza cavo elettrico 5 m
- Triplex pump with ceramic plungers, connecting rod system
- Automatic by-pass valve with pump head pressure discharge
- Brass pump head
- Electric motor with thermal protector
- Pressure adjustment
- Pressure gauge
- Detergent suction
- Inspectable water filter
- Electric cable length 5 m



Carrello con manico orientabile  
Orientable holder  
ø 25 cm



Pulsante di sgancio rapido  
Easy unlock button

### ACCESSORI IN DOTAZIONE

|                             |                       |                                |
|-----------------------------|-----------------------|--------------------------------|
|                             |                       |                                |
| PISTOLA 1/4"<br>M22X1,5 (M) | TUBO ARMATO AP<br>10m | LANCIA<br>CON GETTO REGOLABILE |

| ARTICOLO     | DESCRIZIONE   |
|--------------|---|
| <b>28022</b> | Idropulitrice monofase a freddo 500 l/h 150 bar - con carrello a 2 ruote e pompa a biella/manovella |

### IDROPULTRICE SUPREME 40 (PROFESSIONALE)

NETTOYEUR SUPREME 40  
SUPREME 40 CLEANER  
HOCHDRUCKREINIGER SUPREME 40  
HIDROLAVADORA SUPREME 40



GASOLINE



WOBBLE  
PLATE



RMV



BRASS



50°C 122°F



Acqua fredda  
Cold water

new



- Carrello completo di manico con due ruote e piedini antivibranti
- Pompa a 3 pistoni assiali comandati dal piattello oscillante
- Valvola di by-pass automatica
- Regolazione della pressione
- Valvola termica
- Aspirazione detergente incorporata
- Motorizzato HONDA (benzina), con sensore mancanza olio
- Livelli olio ispezionabili
- Tappi ed asole di scarico per agevolare la manutenzione ed il cambio olio
- Filtro acqua ispezionabile
- Soluzioni studiate per ottimizzare gli ingombri
- Two-wheel trolley with tyres, handle and anti-vibrating feet
- 3 Axial stainless steel pistons wobbleplate pump
- Automatic by-pass valve
- Pressure adjustment
- Thermal valve
- Built-in detergent suction
- Powered by HONDA petrol engine with low oil level sensor
- Inspectable oil levels
- Discharge plugs and discharge slots to make easy the maintenance and the oil change
- Inspectable water filter
- Space-saving solutions

### ACCESSORI IN DOTAZIONE



| ARTICOLO     | DESCRIZIONE  |
|--------------|--|
| <b>28316</b> | Idropulitrice a freddo 660 l/h - 200 bar con carrello a 2 ruote, pompa e motore HONDA GP160H e accessori |

## segue IDROPULTRICI ACQUA FREDDA ANNOVI E REVERBERI

NETTOYEURS A EAU FROIDE - COLD WATER CLEANERS

HOCHDRUCKREINIGER WARMWASSER - HIDROLAVADORA DE AGUA FRÍA

### IDROPULTRICE SUPREME 43 (PROFESSIONALE)

NETTOYEUR SUPREME 43  
SUPREME 43 CLEANER  
HOCHDRUCKREINIGER SUPREME 43  
HIDROLAVADORA SUPREME 43



- Carrello completo di manico con due ruote e piedini antivibranti
- Pompa a 3 pistoni assiali comandati dal piattello oscillante
- Valvola di by-pass automatica
- Regolazione della pressione
- Valvola termica
- Aspirazione detergente incorporata
- Motorizzato RATO (benzina), con sensore mancanza olio
- Livelli olio ispezionabili
- Tappi ed asole di scarico per agevolare la manutenzione ed il cambio olio
- Filtro acqua ispezionabile
- Soluzioni studiate per ottimizzare gli ingombri
- and and anti-vibrating feet
- 3 Axial stainless steel pistons wobble-plate pump
- Automatic by-pass valve
- Pressure adjustment
- Thermal valve
- Built-in detergent suction
- Powered by RATO petrol engine with low oil level sensor
- Inspectable oil levels
- Discharge plugs and discharge slots to make easy the maintenance and the oil change
- Inspectable water filter
- Space-saving solutions
- Two-wheel trolley with tyres, handle

#### ACCESSORI IN DOTAZIONE



| ARTICOLO     | DESCRIZIONE  |
|--------------|--|
| <b>28317</b> | Idropultrice a freddo 720 l/h - 180 bar con carrello a 2 ruote, pompa e motore RATO EHR210 e accessori |

### IDROPULTRICE SUPREME 75 (PROFESSIONALE)

NETTOYEUR SUPREME 75  
SUPREME 75 CLEANER  
HOCHDRUCKREINIGER SUPREME 75  
HIDROLAVADORA SUPREME 75



- Carrello completo di manico con due ruote pneumatiche gonfiabili e piedini antivibranti
- Pompa a pistoni con sistema biellamanovella ad elevate prestazioni
- Valvola di by-pass automatica
- Regolazione della pressione
- Valvola termica
- Aspirazione detergente incorporata
- Motorizzato RATO (benzina), con sensore mancanza olio
- Livelli olio ispezionabili
- Tappi ed asole di scarico per agevolare la manutenzione ed il cambio olio
- Filtro acqua ispezionabile
- Soluzioni studiate per ottimizzare gli ingombri
- table pneumatic wheels and anti-vibrating feet
- High performance piston pump with connecting rod system
- Automatic by-pass valve
- Pressure adjustment
- Thermal valve
- Built-in detergent suction
- Powered by RATO petrol engine with low oil level sensor
- Inspectable oil levels
- Discharge plugs and discharge slots to make easy the maintenance and the oil change
- Inspectable water filter
- Space-saving solutions
- Two-wheel trolley with handle, infla-

#### ACCESSORI IN DOTAZIONE



| ARTICOLO     | DESCRIZIONE  |
|--------------|--|
| <b>28318</b> | Idropultrice a freddo 960 l/h - 280 bar con carrello a 2 ruote, pompa e motore RATO EHR390 e accessori |



**ANNOVI  
REVERBERI**  
The Power of Experience

# Idropulitrici WATER CLEANERS

16

## IDROPULITRICI ACQUA CALDA ANNOVI E REVERBERI NETTOYEURS A EAU CHAUDE - HOT WATER CLEANERS HOCHDRUCKREINIGER HEISSESWASSER - HIDROLAVADORA DE AGUA CALIENTE

### IDROPULITRICE HOT 1408 (SEMIPROFESSIONALE)

NETTOYEUR HOT 1408  
HOT 1408 CLEANER  
HOCHDRUCKREINIGER HOT 1408  
HIDROLAVADORA HOT 1408

new

**TSS®**  
Total Stop  
SYSTEM



Acqua calda  
Hot Water



Per uso frequente  
For frequent usage



Accessori professionali  
Professional accessories



- Pompa a 3 pistoni assiali comandati da piattello oscillante
- Pistoni in acciaio inox temprato
- Testa pompa in ottone
- Valvola di by-pass automatica con azzeramento della pressione nella testa della pompa
- Motore elettrico a induzione con protezione termica
- Sistema di arresto totale dell' idropulitrice a distanza
- Pressostato di sicurezza per spegnimento della caldaia in caso di mancanza acqua
- Caldaia verticale, doppia serpentina e fondo in materiale refrattario
- Serbatoio gasolio 4 l
- Filtro acqua e filtro aspirazione gasolio
- Lunghezza cavo elettrico 5 m

- 3 Axial stainless steel pistons wobble-plate pump
- Tempered stainless steel pistons
- Brass pump head
- Automatic by-pass valve with pump head pressure discharge
- Single-phase induction electric motor with thermal protector
- Remote Total Stop System of the cleaner
- With safety pressure switch to shut down the boiler in case of lack of water
- Vertical boiler with double heating coil and refractory compound base
- Fuel tank capacity 4 l
- Water filter and fuel inlet filter
- Electric cable length 5 m

#### ACCESSORI IN DOTAZIONE

|                                      |        |                |                       |                                       |
|--------------------------------------|--------|----------------|-----------------------|---------------------------------------|
|                                      |        |                |                       |                                       |
| PISTOLA 3/8" (M)<br>M22X1,5 (100° C) | LANCIA | UGELLO 1/4 MEG | TUBO ARMATO<br>AP 8 m | KIT SCHIUMOGENO<br>CON SERBATOIO 0,5l |

| ARTICOLO     | DESCRIZIONE  |
|--------------|--|
| <b>28023</b> | Idropulitrice monofase a caldo 480 l/h 140 bar - con carrello a 2 ruote, pompa a piattello |

# Accessori per Idropulitrici

## ACCESSORIES FOR CLEANERS

# 16

16

### LANCIA LAVAGGIO

SPRAY GUN  
WASHING LANCE  
SPRITZPISTOLE  
LANZA



### CARATTERISTICHE

- Ugello M15x1 Ø 1,5
- Attacco G1/2M.
- Foro max. ugello: Ø 2,3 mm
- Pressione massima d'esercizio 250 bar.
- Lunghezza: 720 mm
- **Materiali:** ottone - acciaio inox - materiali plastici ad alta resistenza.
- **Impiego:** lavaggio in agricoltura ed industria fino a 100°C. Ugello protetto dagli urti. Angolo di spruzzo regolabile in continuo mediante l'impugnatura anteriore. Il sotto insieme lavaggio può essere assemblato alle più diffuse impugnature per ottenere la regolazione continua dell'angolo di spruzzo. Dotata di fermo di sicurezza della leva contro le aperture accidentali e di protezione per la mano dell'operatore a norma ISO/EN.

ARTICOLO  
**27939**

### ACCESSORI PER IDROPULITRICI

ACCESSOIRES POUR NETTOYEURS HAUTE PRESSION - ACCESSORIES FOR HIGH PRESSURE CLEANERS - ZUBEHÖRTEILE FÜR HOCHDRUCKREINIGER - ACCESORIOS PARA HIDROLAVADORAS

### ESEMPI DI COMPOSIZIONE

EXEMPLES DE COMPOSITION  
COMPOSITION EXAMPLES  
ZUSAMMENSETZUNGSBEISPIELE  
EJEMPLOS DE COMPOSICIÓN

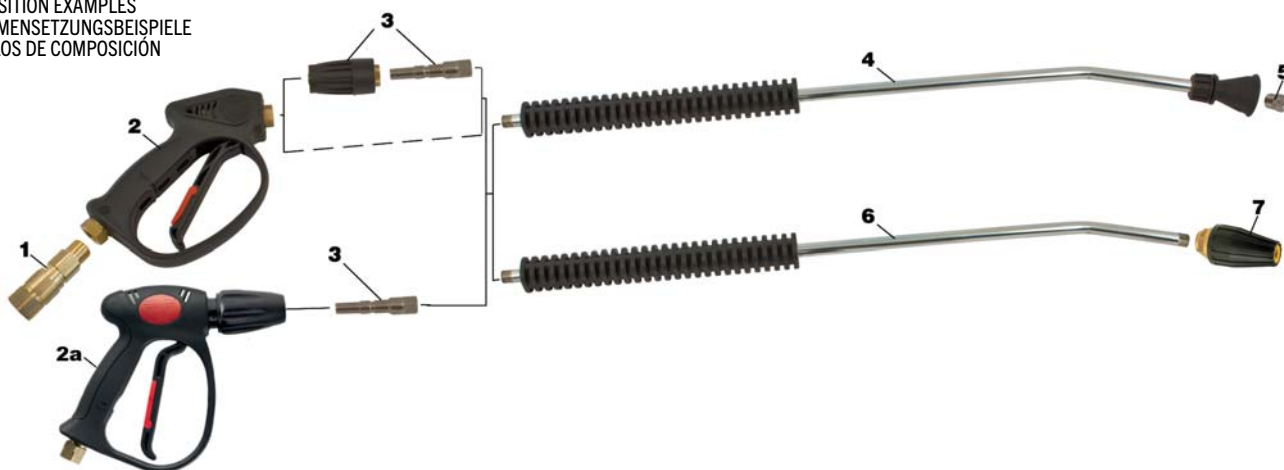

### PISTOLE AUTOMATICHE ALTA PRESSIONE (FIG.2 - 2A)

PISTOLETS AUTOMATIQUES HAUTE PRESSION - HIGH PRESSURE AUTOMATIC GUNS - HOCHDRUCK AUTOMATISCHE PISTOLE - PISTOLA AUTOMATICA ALTA PRESIÓN



(fig. 2)



(fig. 2)



(fig. 2a)

| ARTICOLO     | DESCRIZIONE   | ARTICOLO     | DESCRIZIONE  | ARTICOLO     | DESCRIZIONE   |
|--------------|---|--------------|--|--------------|---|
| <b>26780</b> | Pistola per acqua calda e fredda<br>Entrata 3/8" G Femmina girevole<br>Uscita 1/4" G Femmina<br>Pressione MAX 310 bar<br>Portata MAX 30 l/min<br>Temperatura MAX 160° | <b>26781</b> | Pistola per acqua calda e fredda<br>Entrata 3/8" G Femmina<br>Uscita 1/4" G Femmina<br>Pressione MAX 310 bar<br>Portata MAX 30 l/min<br>Temperatura MAX 160° | <b>28012</b> | Pistola per acqua calda e fredda<br>Entrata 3/8" G Femmina girevole<br>Uscita Attacco rapido Femmina<br>Pressione MAX 310 bar<br>Portata MAX 30 l/min<br>Temperatura MAX 150° |

### LANCE ZINCATE FUSE QUADRATE PER UGELLI VENTAGLIO (FIG.4)

LANCES ZINGUEES CARREES  
GALVANIZED SQUARE-MELTED LANCES  
VERZINKTE VIERECKIGE SPRITZPISTOLE  
LANZA GALVANIZADA FUNDIDA CUADRADA



#### Caratteristiche Tecniche:

- Pressione Max.: 280 bar.
- Portata Max.: 40 l/min.
- Temperatura Max.: 150° C.
- Fornite senza ugello.

| ARTICOLO     | ENTRATA        | USCITA         | LUNGHEZZA mm |
|--------------|----------------|----------------|--------------|
| <b>26783</b> | 1/4" G Maschio | 1/4" G Femmina | 700          |
| <b>26784</b> | 1/4" G Maschio | 1/4" G Femmina | 900          |
| <b>26785</b> | 1/4" G Maschio | 1/4" G Femmina | 1200         |
| <b>26786</b> | 1/4" G Maschio | 1/4" G Femmina | 1500         |
| <b>26787</b> | 1/4" G Maschio | 1/4" G Femmina | 1700         |
| <b>26788</b> | 1/4" G Maschio | 1/4" G Femmina | 2000         |

### UGELLI PER LANCE (FIG.5) VENTAGLIO 25°

BUSES POUR LANCES  
LANCES NOZZLE  
SPRITZDÜSE  
BOQUILLAS PARA LANZAS



| CON INSERTO IN CERAMICA ARTICOLO | TUTTO INOX ARTICOLO | ATTACCO        | CODICE ORIFIZIO | PORTATE UGELLI (l/min) |         |         |         |         |
|----------------------------------|---------------------|----------------|-----------------|------------------------|---------|---------|---------|---------|
|                                  |                     |                |                 | 80 bar                 | 100 bar | 120 bar | 140 bar | 160 bar |
| <b>27026</b>                     | <b>26789</b>        | 1/4" G Maschio | 03              | 6,1                    | 6,8     | 7,5     | 8,1     | 8,6     |
| <b>27027</b>                     | <b>26790</b>        | 1/4" G Maschio | 04              | 8,2                    | 9,1     | 10,0    | 10,8    | 11,5    |
| <b>27028</b>                     | <b>26791</b>        | 1/4" G Maschio | 045             | 9,2                    | 10,3    | 11,2    | 12,1    | 13,0    |
| <b>27029</b>                     | <b>26792</b>        | 1/4" G Maschio | 05              | 10,2                   | 11,4    | 12,5    | 13,0    | 13,8    |
| <b>27030</b>                     | <b>26793</b>        | 1/4" G Maschio | 055             | 11,2                   | 12,5    | 13,7    | 14,8    | 15,9    |
| <b>27031</b>                     | <b>26794</b>        | 1/4" G Maschio | 06              | 12,2                   | 13,7    | 15,0    | 16,2    | 17,3    |
| <b>27032</b>                     | <b>26795</b>        | 1/4" G Maschio | 065             | 13,3                   | 14,8    | 16,2    | 17,5    | 18,7    |

### LANCE ZINCATE FUSE QUADRATE PER TESTINE TURBO (FIG.6)

LANCES ZINGUEES CARREES  
GALVANIZED SQUARE-MELTED LANCS  
VERZINKTE VIERECKIGE SPRITZPISTOLE  
LANZA GALVANIZADA FUNDIDA CUADRADA



#### CLASSE 110

##### Caratteristiche Tecniche:

- Pressione Max.: 280 bar.
- Portata Max.: 40 l/min.
- Temperatura Max.: 150° C.
- Fornite senza turbo.

| ARTICOLO     | ENTRATA        | USCITA         | LUNGHEZZA mm |
|--------------|----------------|----------------|--------------|
| <b>27033</b> | 1/4" G Maschio | 1/4" G Maschio | 700          |
| <b>27034</b> | 1/4" G Maschio | 1/4" G Maschio | 900          |
| <b>27035</b> | 1/4" G Maschio | 1/4" G Maschio | 1200         |

### TESTINE TURBO NON REGISTRABILI (FIG.7)

TETES TURBO NON RÉGLABLE (fig.7)  
NON-ADJUSTABLE TURBO HEADS (fig.7)  
TURBOKÖPFE NICHT VERSTELLBAR (Abb.7)  
CABEZALES TURBO NO AJUSTABLE (fig.7)



#### CLASSE 65

##### Caratteristiche Tecniche:

- Pressione Max.: 250 bar.
- Temperatura Max.: 90° C.

| ARTICOLO     | ATTACCO        | CODICE ORIFIZIO | PORTATE UGELLI (l/min) |         |         |         |         |         |         |
|--------------|----------------|-----------------|------------------------|---------|---------|---------|---------|---------|---------|
|              |                |                 | 80 bar                 | 100 bar | 120 bar | 160 bar | 200 bar | 250 bar | 300 bar |
| <b>27036</b> | 1/4" G Femmina | 035             | 7,3                    | 8,2     | 9,0     | 10,4    | 11,6    | 13,0    | 14,2    |
| <b>27037</b> | 1/4" G Femmina | 04              | 8,0                    | 9,0     | 9,9     | 11,4    | 12,7    | 14,2    | 15,6    |
| <b>27038</b> | 1/4" G Femmina | 05              | 10,8                   | 12,1    | 13,3    | 15,3    | 17,1    | 19,1    | 21,0    |
| <b>27039</b> | 1/4" G Femmina | 06              | 12,2                   | 13,6    | 14,9    | 17,2    | 19,2    | 21,5    | 23,6    |
| <b>27040</b> | 1/4" G Femmina | 065             | 13,2                   | 14,8    | 16,2    | 18,7    | 20,9    | 23,4    | 25,6    |
| <b>27041</b> | 1/4" G Femmina | 07              | 14,4                   | 16,1    | 17,6    | 20,4    | 22,8    | 25,5    | 27,9    |

### ATTACCHI RAPIDI PER LANCE (FIG.3)

RACCORDE RAPIDES POUR LANCES (fig.3)  
QUICK COUPLINGS FOR SPRAY GUNS (fig.3)  
SCHNELLKUPPLUNGEN FÜR SPRITZROHRE (Abb.3)  
ACOPLAMIENOS RÁPIDOS PARA LANZAS (fig.3)



FEMMINA FIG.1



MASCHIO FIG.2

#### CLASSE 65

##### Caratteristiche Tecniche:

- Pressione Max.: 350 bar.
- Portata Max.: 40 l/min.
- Temperatura Max.: 150° C.

| ARTICOLO     | PARTE   | FILETTO | FIG. |
|--------------|---------|---------|------|
| <b>27042</b> | Femmina | M 1/4"  | 1    |
| <b>27043</b> | Maschio | F 1/4"  | 2    |

### GIUNTO GIREVOLE PER PISTOLA IDROPULITRICE (FIG.1)

JOINT PIVOTANT POUR PISTOLET NETTOYEUR HAUTE PRESSION (fig.1)  
SWIVEL FITTING FOR HIGH PRESSURE CLEANER (fig.1)  
DREHKUPPLUNGEN FÜR PISTOLE HOCHDRUCKREINIGER (Abb.1)  
ACOPLAMIENTO GIRATORIO PARA PISTOLA HIDROLAVADORA (fig.1)



##### Caratteristiche Tecniche:

- Filetto 3/8".
- Pressione Max.: 350 bar.
- Portata Max.: 40 l/min.
- Temperatura Max.: 160° C.

| ARTICOLO     |
|--------------|
| <b>27044</b> |

### ATTACCHI RAPIDI DA 3/8" PER TUBO

RACCORDS RAPIDES POUR TUYAU 3/8"  
 QUICK COUPLINGS FOR 3/8" HOSE  
 SCHNELLKUPPLUNGEN FÜR 3/8"  
 ACOPLAMIENTOS RÁPIDOS PARA TUBO 3/8"



FIG.1



FIG.2

| ARTICOLO | DESCRIZIONE                             | FIGURA |
|----------|---|--------|
| 27554    | Attacco rapido maschio da 3/8" per tubo | 1      |
| 27555    | Attacco rapido femmina da 3/8" per tubo | 2      |

### AVVOLGITUBO IN ACCIAIO VERNICIATO CON TAMBURO IN ABS

ENROULEUR TUYAU EN ACIER PEINT AVEC TAMBOUR EN ABS  
 HOSE REEL IN PAINTED STEEL WITH DRUM IN ABS  
 SCHLAUCHTROMMEL AUS LACKIERTEM STAHL MIT ABS-TROMMEL  
 ENROLLADOR DE TUBO DE ACERO PINTADO CON TAMBOR DE ABS



**NOTE:**

- Per acqua calda (130°).
- Snodo in acciaio inox AISI 304 verniciato.
- Tamburo in ABS antiurto.
- Guarnizioni in "Viton".
- Tubo in gomma sintetica nera.
- Raccordi in acciaio zincato.

| ARTICOLO | Ø int. TUBO | TUBO m | PRESS. MAX. bar | TEMP. UTILIZZO °C | RACC. USCITA | RACC. INGRESSO |
|----------|-------------|--------|-----------------|-------------------|--------------|----------------|
| 27210    | 3/8"        | 18     | 200             | 130               | F3/8"G       | F3/8"G         |

### AVVOLGITUBO IN ACCIAIO INOX CON TAMBURO IN ABS

ENROULEUR TUYAU EN ACIER INOX AVEC TAMBOUR EN ABS  
 HOSE REEL IN STAINLESS STEEL WITH DRUM IN ABS  
 SCHLAUCHTROMMEL AUS RÖSTFREIEM STAHL MIT ABS-TROMMEL  
 ENROLLADOR DE TUBO DE ACERO INOXIDABLE CON TAMBOR DE ABS



**NOTE:**

- Per acqua calda (130°).
- Snodo in acciaio inox AISI 304.
- Tamburo in ABS antiurto.
- Guarnizioni in "Viton".
- Tubo in gomma sintetica antimacchia.
- Raccordi in acciaio zincato.

| ARTICOLO | Ø int. TUBO | TUBO m | PRESS. MAX. bar | TEMP. UTILIZZO °C | RACC. USCITA | RACC. INGRESSO |
|----------|-------------|--------|-----------------|-------------------|--------------|----------------|
| 27211    | 3/8"        | 18     | 200             | 130               | F3/8"G       | F3/8"G         |



### TUBO K-JET 1 TRECCIA

TUYAU K-JET 1 TRESSE  
K-JET 1-PLY HOSE  
SCHLAUCH K-JET 1 GEFLECHT  
TUBO K-JET 1 TRENZA



#### CARATTERISTICHE:

- **SOTTOSTRATO:** Gomma sintetica resistente all'acqua
- **RINFORZO:** Una treccia d'acciaio ad alto carico
- **COPERTURA:** Gomma sintetica speciale con alta resistenza all'abrasione, agli attacchi dell'ozono ed agli agenti atmosferici
- **CARATTERISTICHE SPECIALI:** Progettato in accordo con la ICE 335-2 (Norma Europea di riferimento per i principali costruttori di macchine idropulitrici), fattore di sicurezza 4:1 ideale per macchine hobbystiche e semiprofessionali
- Servizio continuativo: -10°C ÷ +155°C, minima temperatura operativa: -40°C

**FLUIDI RACCOMANDATI:** Acqua

#### TUBO COLORE NERO

| ARTICOLO     | Ø INT.<br>IN POLLICI | Ø INT.<br>mm | Ø EST.<br>mm | MAX PRESS.<br>ESERC. ATL. | PRESS. SCOPPIO<br>bar | BOCCOLA<br>ARTICOLO |
|--------------|----------------------|--------------|--------------|---------------------------|-----------------------|---------------------|
| <b>81842</b> | 1/4"                 | 6,4          | 13,2         | 210                       | 1120                  | <b>80075</b>        |
| <b>81510</b> | 5/16"                | 7,9          | 14,8         | 210                       | 1000                  | <b>80076</b>        |
| <b>81545</b> | 3/8"                 | 9,5          | 17           | 210                       | 840                   | <b>80077</b>        |

#### TUBO COLORE BLU

| ARTICOLO     | Ø INT.<br>IN POLLICI | Ø INT.<br>mm | Ø EST.<br>mm | MAX PRESS.<br>ESERC. ATL. | PRESS. SCOPPIO<br>bar | BOCCOLA<br>ARTICOLO |
|--------------|----------------------|--------------|--------------|---------------------------|-----------------------|---------------------|
| <b>82261</b> | 1/4"                 | 6,4          | 13,2         | 210                       | 1120                  | <b>80075</b>        |
| <b>82262</b> | 5/16"                | 7,9          | 14,8         | 210                       | 1000                  | <b>80076</b>        |
| <b>82263</b> | 3/8"                 | 9,5          | 17           | 210                       | 840                   | <b>80077</b>        |

### TUBO SUPERJET 2 TRECCE

TUYAU SUPERJET 2 TRESSES  
SUPERJET 2-PLY HOSE  
SCHLAUCH SUPERJET 2 GEFLECHTE  
TUBO SUPERJET 2 TRENZAS



#### CARATTERISTICHE:

- **SOTTOSTRATO:** Gomma sintetica resistente all'acqua
- **RINFORZO:** Due treccia d'acciaio ad alto carico
- **COPERTURA:** Gomma sintetica speciale con alta resistenza all'abrasione, agli attacchi dell'ozono ed agli agenti atmosferici
- **CARATTERISTICHE SPECIALI:** Progettato in accordo con la ICE 335-2 (Norma Europea di riferimento per i principali costruttori di macchine idropulitrici), fattore di sicurezza 4:1 ideale per macchine professionali
- Servizio continuativo: -10°C ÷ +155°C, minima temperatura operativa: -40°C

**FLUIDI RACCOMANDATI:** Acqua

#### TUBO COLORE NERO

| ARTICOLO     | Ø INT.<br>IN POLLICI | Ø INT.<br>mm | Ø EST.<br>mm | MAX PRESS.<br>ESERC. ATL. | PRESS. SCOPPIO<br>bar | BOCCOLA<br>ARTICOLO |
|--------------|----------------------|--------------|--------------|---------------------------|-----------------------|---------------------|
| <b>82264</b> | 1/4"                 | 6,4          | 14,7         | 400                       | 1600                  | <b>80075</b>        |
| <b>82265</b> | 5/16"                | 7,9          | 16,3         | 350                       | 1400                  | <b>80076</b>        |
| <b>82266</b> | 3/8"                 | 9,5          | 16,8         | 330                       | 1320                  | <b>80077</b>        |

#### TUBO COLORE BLU

| ARTICOLO     | Ø INT.<br>IN POLLICI | Ø INT.<br>mm | Ø EST.<br>mm | MAX PRESS.<br>ESERC. ATL. | PRESS. SCOPPIO<br>bar | BOCCOLA<br>ARTICOLO |
|--------------|----------------------|--------------|--------------|---------------------------|-----------------------|---------------------|
| <b>82267</b> | 1/4"                 | 6,4          | 14,7         | 400                       | 1600                  | <b>80075</b>        |
| <b>82268</b> | 5/16"                | 7,9          | 16,3         | 350                       | 1400                  | <b>80076</b>        |
| <b>82269</b> | 3/8"                 | 9,5          | 16,8         | 330                       | 1320                  | <b>80077</b>        |

### MANICOTTO PER TUBO DA IDROPULITRICE

MANCHON POUR LAVEUSES  
COUPLING FOR WASHING MACHINES  
PLASTIKSCHUTZ FÜR HOCHDRUCKREINIGER  
ASIDERO DE MAQUINA DE LAVAR



| ARTICOLO     | Ø INT.<br>mm | LUNGH.<br>mm |
|--------------|--------------|--------------|
| <b>81860</b> | 19           | 135          |
| <b>81861</b> | 21           |              |

### RACCORDO FILETTATO FEMMINA DRITTO

RACCORD FILETE FEMELE DROIT  
STRAIGHT FEMALE THREADED FITTING  
ARAMTUR MIT ÜBERWURFMUTTER ZUM PRESSEN  
RACOR ROSCADO HEMBRA RECTO



| ARTICOLO     | Ø TUBO | FILETTO |
|--------------|--------|---------|
| <b>80097</b> | 1/4"   | 3/8"    |
| <b>80098</b> | 5/16"  | 3/8"    |
| <b>80100</b> | 3/8"   | 3/8"    |

### RACCORDI A PRESSARE PER TUBI DA IDROPULITRICE

RACCORS POUR LAVEUSES  
COUPLING FOR HYDRO - POLISHING MACHINES  
SPANNHÜSENSATZ FÜR WASSERPUTZEMASCHINEN  
RACORES PARA MAQUINAS DE LAVAR



| ARTICOLO     | Ø TUBO | FILETTO |
|--------------|--------|---------|
| <b>81862</b> | 1/4"   | 22x1,5  |
| <b>81863</b> | 5/16"  | 22x1,5  |
| <b>81864</b> | 3/8"   | 22x1,5  |

# Accessori per Idropulitrici

## ACCESSORIES FOR CLEANERS

# 16

### TUBI RACCORDATI PER IDROPULITRICI COMPLETI DI MANICOTTO

TUYAUX SERTI POUR LAVEUSES AVEC MANCHON  
 FITTED HOSES FOR HIGH PRESSURE WASHING MACHINES INCLUSE OF HANDLE  
 SCHLAUCHENMIT ANSCHLÜSSEN FÜR HOCHDRUCKREINIGER MIT MANSCHETTE  
 MASQUERA CON RACORES PARA MAQUINA DE LAVAR Y SU ASIERO

new



| TUBO 2SC NERO |        |          | TUBO 2SC BLU |        |          | RACCORDI                                  |
|---------------|--------|----------|--------------|--------|----------|---|
| ARTICOLO      | Ø TUBO | LUNGH. m | ARTICOLO     | Ø TUBO | LUNGH. m |   |
| 81844         | 1/4"   | 10       | -            | -      | -        | Femmina diritta da 3/8" + Raccordo 22x1,5 |
| 81845         | 1/4"   | 15       | -            | -      | -        |   |
| 81846         | 1/4"   | 20       | -            | -      | -        |   |
| 81847         | 1/4"   | 25       | -            | -      | -        |   |
| 81852         | 5/16"  | 10       | 83629        | 5/16"  | 10       |   |
| 81853         | 5/16"  | 15       | 83630        | 5/16"  | 15       |   |
| 81854         | 5/16"  | 20       | 83631        | 5/16"  | 20       |   |
| 81855         | 5/16"  | 25       | 83632        | 5/16"  | 25       |   |
| 81856         | 3/8"   | 10       | 83633        | 3/8"   | 10       |   |
| 81857         | 3/8"   | 15       | 83634        | 3/8"   | 15       |   |
| 81858         | 3/8"   | 20       | 83635        | 3/8"   | 20       |   |
| 81859         | 3/8"   | 25       | 83636        | 3/8"   | 25       |   |

| TUBO 2SC NERO |        |          | TUBO 2SC BLU |        |          | RACCORDI  |
|---------------|--------|----------|--------------|--------|----------|---|
| ARTICOLO      | Ø TUBO | LUNGH. m | ARTICOLO     | Ø TUBO | LUNGH. m |   |
| 84104         | 5/16"  | 10       | 84108        | 5/16"  | 10       | Femmina diritta da 3/8" + Femmina diritta da 3/8" |
| 84105         | 5/16"  | 15       | 84109        | 5/16"  | 15       |   |
| 84106         | 5/16"  | 20       | 84110        | 5/16"  | 20       | Femmina diritta da 3/8"                           |
| 84107         | 5/16"  | 25       | 84111        | 5/16"  | 25       |   |

### RACCORDI PER IDROPULITRICI

RACCORD POUR NETTOYEURS  
 HIGH-PRESSURE CLEANERS FITTING  
 GELENK FUER HOCHDRUCKREINIGER  
 RACOR PARA HIDROLAVADORAS



FIG.1



FIG.2

| ARTICOLO | ENTRATA | ATTACCO   | TIPO  | MANOPOLA | FIG. |
|----------|---------|-----------|-------|----------|------|
| 83934    | G 1/2 F | M22x1,5 F | Corto | Corta    | 1    |
| 83931    | G 1/2 M | M22x1,5 F | Corto | Corta    | 2    |
| 83933    | G 3/8 F | M22x1,5 F | Corto | Corta    | 1    |
| 83930    | G 3/8 M | M22x1,5 F | Corto | Corta    | 2    |
| 83932    | G 1/4 F | M22x1,5 F | Corto | Corta    | 1    |
| 83929    | G 1/4 M | M22x1,5 F | Corto | Corta    | 2    |

### NIPPLES DI CONGIUNZIONE

RACCORD DE JONCTION  
 STRAIGHT ADAPTER  
 DOPPELSTÜTZEN  
 RACOR INTERMEDIO



| ARTICOLO | ENTRATA | ATTACCO   |
|----------|---------|-----------|
| 28056    | G 3/8 M | M22x1,5 M |
| 28057    | G 1/2 M | M22x1,5 M |

## ASPIRA POLVERE/LIQUIDI SEMI PROFESSIONALE - CV 30 XE -

ASPIRATEUR/NETTOYEUR DEMI-PROFESSIONNEL - CV 30 XE  
SEMIPROFESSIONAL WET&DRY VACUUM CLEANER - CV 30 XE -  
HALBPROFESSIONELL STAUBSAUGER - CV 30 XE  
ASPIRADORA SEMI-PROFESIONAL - CV 30 XE



### CARATTERISTICHE GENERALI

- Motore silenzioso
- Doppio isolamento elettrico
- Sistema aspirante con raffreddamento by-pass
- Fusto in acciaio inox
- Presa per elettroutensili (max 2200 W)
- Tubi di prolunga in acciaio
- Ganci professionali in metallo
- Cavo elettrico 5 m
- Tubo flex 4 m
- Vano portaccessori
- Accessori Ø 35

### GENERAL FEATURES

- Silenced motor
- Double electrical insulation
- Suction system with by-pass cooling
- Stainless steel tank
- Power tool socket (max 2200 W)
- Steel extension pipe
- Professional closing hooks
- 5 m power cable
- Flexible hose 4 m
- Handy accessory holder
- Accessories Ø 35



SACCHETTO DI  
RICAMBIO (x5)

**28097**

| ARTICOLO     | ALIMENTAZIONE<br>POWER SUPPLY | POTENZA ASSORBITA<br>WORKING CAPACITY | CAPACITA' SERBATOIO |         |         | PORTATA ARIA<br>AIR FLOW RATE | Nr. MOTORI ASPIRAZIONE<br>N° VACUUM MOTOR | PESO<br>WEIGHT |
|--------------|-------------------------------|---------------------------------------|---------------------|---------|---------|-------------------------------|---|----------------|
|              |                               |                                       | TOTALE              | POLVERI | LIQUIDI |                               |   |                |
| <b>28095</b> | 220/240 V<br>50/60 Hz         | 1400 W<br>(max 1600 W)                | 30 l                | 20 l    | 24 l    | 70 l/s                        | 1   | 8,2 kg         |

## ASPIRA POLVERE/LIQUIDI PROFESSIONALE - CVP 265 X -

ASPIRATEUR/NETTOYEUR PROFESSIONNEL - CV 265 X  
SEMIPROFESSIONAL WET&DRY VACUUM CLEANER - CVP 265 X -  
PROFESSIONELL STAUBSAUGER - CV 265 X  
ASPIRADORA PROFESIONAL - CV 265 X



### CARATTERISTICHE GENERALI

- 2 motori ad alta efficienza
- Sistema aspirante con raffreddamento by-pass
- Sistema di pulizia del filtro
- Fusto in acciaio inox
- Sistema antielettrostaticità
- Carrello antiurto
- Valvola a galleggiante
- Filtro panno
- Cavo di alimentazione 7,5 m
- Ruote antitraccia
- Pratico porta accessori
- Accessori Ø 40

### GENERAL FEATURES

- 2 high efficiency by pass motors
- Suction system with by-pass cooling
- Filter cleaning system
- Stainless steel tank
- Static electric shock inhibitor
- Shock proof trolley
- Liquid float valve
- Cloth filter
- 7,5 m power cable
- Traceless wheels
- Handy accessory holder
- Accessories Ø 40



FILTRO DI  
RICAMBIO

**28098**

| ARTICOLO     | ALIMENTAZIONE<br>POWER SUPPLY | POTENZA ASSORBITA<br>WORKING CAPACITY | CAPACITA' SERBATOIO |         |         | PORTATA ARIA<br>AIR FLOW RATE | Nr. MOTORI ASPIRAZIONE<br>N° VACUUM MOTOR | PESO<br>WEIGHT |
|--------------|-------------------------------|---------------------------------------|---------------------|---------|---------|-------------------------------|---|----------------|
|              |                               |                                       | TOTALE              | POLVERI | LIQUIDI |                               |   |                |
| <b>28096</b> | 220/240 V<br>50/60 Hz         | 2000 W<br>(max 2400 W)                | 65 l                | 30 l    | 40 l    | 130 l/s                       | 2   | 14,5 kg        |

# Aspiratori VACUUM CLEANERS

16

## ASPIRATORE SOLIDI E LIQUIDI - WD25 -

ASPIRATEUR SOLIDES ET LIQUIDES - WD25 -  
WET & DRY VACUUM CLEANER - WD25 -  
FEST- UND FLÜSSIGSTOFFSAUGER - WD25 -  
ASPIRADOR DE SÓLIDOS Y LÍQUIDOS - WD25 -



new



- Aspiratore per liquidi e polveri
- Fusto raccolta in materiale plastico robusto e resistente
- Tubo d'aspirazione flessibile e resistente alla torsione
- Portaccessori integrato
- Posizione parcheggio durante le soste di lavoro
- Gancio per rimessaggio cavo d'alimentazione
- Galleggiante per interrompere l'aspirazione quando il fusto è pieno
- Cerniere aggancio-sgancio rapido per pulizia filtri e fusto
- Funzione soffiante
- Filtro alta efficienza lavabile
- Cavo elettrico di 5 metri
- Wet & Dry vacuum cleaner
- Tough, sturdy plastic tank
- Flexible, kink-resistant suction hose
- Integral accessories carrier
- Parking position for use during breaks in work
- Hook for stowing power supply cable
- Float switch to cut out suction when tank is full
- Quick connection/release hinges for filter and tank cleaning
- Blower function
- Washable high efficiency filter
- 5m power cord

### ACCESSORI IN DOTAZIONE



### RICAMBI



SACCHETTO DI RICAMBIO  
(5 PZ.)

**28322**

| ARTICOLO     | DESCRIZIONE   |
|--------------|---|
| <b>28320</b> | Aspiratore 4 ruote con fusto da 25 l in plastica per solidi, liquidi e con funzione soffiante |

## ASPIRATORE SOLIDI LIQUIDI E CENERI - AR20M -

ASPIRATEUR SOLIDES LIQUIDES ET CENDRES - AR20M -  
ASH, WET & DRY VACUUM CLEANER - AR20M -  
SAUGER FÜR FEST- UND FLÜSSIGSTOFFE UND ASCHE - AR20M -  
ASPIRADOR DE SÓLIDOS, LÍQUIDOS Y POLVO - AR20M -



new



- Aspiratore per ceneri, liquidi e polveri
- Fusto raccolta in acciaio inossidabile
- Tubo d'aspirazione flessibile e resistente alla torsione e tubo aspirazione flessibile in metallo rivestito
- Portaccessori integrato
- Posizione parcheggio durante le soste di lavoro
- Gancio per rimessaggio cavo d'alimentazione
- Galleggiante per interrompere l'aspirazione quando il fusto è pieno
- Cerniere aggancio-sgancio rapido per pulizia filtri e fusto
- Funzione soffiante
- Filtro alta efficienza lavabile
- Cavo elettrico di 5 metri
- Ash, Wet & Dry vacuum cleaner
- Stainless steel tank
- Flexible, kink-resistant suction hose and Metal coated flexible suction hose for ash
- Integral accessories carrier
- Parking position for use during breaks in work
- Hook for stowing power supply cable
- Float switch to cut out suction when tank is full
- Quick connection/release hinges for filter and tank cleaning
- Blower function
- Washable high efficiency filter
- 5m power cord

### ACCESSORI IN DOTAZIONE



### RICAMBI



FILTRO CARTUCCIA  
PER CENERI  
DI RICAMBIO

**28323**

| ARTICOLO     | DESCRIZIONE   |
|--------------|---|
| <b>28321</b> | Aspiratore 4 ruote con fusto da 20 l in acciaio inox per solidi, liquidi, ceneri e con funzione soffiante |