



11

www.cermag.com

Frizioni e Bandelle freno

*EMBAYAGES ET BANDES FRAIN
CLUTCHES AND BRAKE BELTS
KUPPLUNGEN UND BREMSBÄNDER
EMBRAGUES Y BANDAS FRENO*

Frizioni e loro componenti

CLUTCHES - CLUTCH DISK - BEARING - COUPLING - LEVER - SET-REVISION

11

11 KIT LUK PER IL MONTAGGIO E CENTRAGGIO DELLA FRIZIONE DEI TRATTORI

JEU LUK POUR L'ENSEMBLE ET LE CENTRAGE DES EMBRAYAGES DU TRACTEURS
 LUK KIT FOR MOUNTING AND ALIGNING OF TRACTORS' CLUTCHES
 KIT ZUR KUPPLUNGSANRICHT. LUK
 KIT LUK PARA EL MONTAJE Y CENTRADO DE LOS EMBRAGUES DE TRACTORES



CARATTERISTICHE

Innovativo kit per il centraggio della frizione in grado di essere utilizzato con tutte le principali dimensioni del mozzo del cuscinetto.

L'attrezzo garantisce montaggi veloci ed accurati riducendo il rischio di danni durante lo svolgimento della riparazione.

Il kit è adatto ad essere utilizzato su trattori CNH, John Deere, Landini, Massey Ferguson, SDF e altri marchi.

Il kit completo include 32 centratori volano e 11 centratori disco.







Centratori volano: 14mm fino a 45mm

Centratori disco: 12mm, 14mm, 15mm, 16mm, 17mm, 20mm, 22mm, 25mm, 30mm, 36mm, 40mm















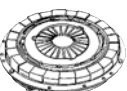

ARTICOLO	DESCRIZIONE
16108	Valigetta kit montaggio frizioni composta da: Centratori volano da 14mm fino a 45mm Centratori disco da 12mm, 14mm, 15mm, 16mm, 17mm, 20mm, 22mm, 25mm, 30mm, 36mm e 40mm

ADRIATICA MACCHINE

MOTAZAPPE E MOTOCOLIVATORI (DAL 1993 IN AVANTI)	 Art. 15519	OEM Frizione conica Ø 103x90 mm Albero Ø 23 mm Conicità 1:5 14x11x3 mm - Z.6		
MOTOCOLTIVATORI 10 HP (DAL 1993 IN AVANTI)	 Art. 15521	OEM Frizione Ø 103x90 mm a dischi multipli con 4 dischi 14x11x3 mm - Z.6 Albero Ø23 mm		
MOTOCOLTIVATORI 12 HP (DAL 1994 IN AVANTI)	 Art. 15620	OEM Frizione Ø 103x90 mm a dischi multipli con 4 dischi 14x11x3 mm - Z.6 Albero Ø23 filettato		
MINIMEC SUPERMEC 14 HP (segue ADRIATICA MACCHINE)	 Art. 15354	OEM Frizione monodisco a molle elicoidali Piatto Ø 140 mm	 Art. 15020	OEM Disco frizione rigido 140x96x3,8 mm 17x15EV Z.20
			 Art. 15044	OEM Manicotto con anello in grafite





segue ADRIATICA MACCHINE

SUPERMEC 18 HP	Art. 15016	OEM Frizione monodisco a molle elicoidali Piatto Ø 155 mm		Art. 15198	OEM Disco frizione rigido 155x114x4 mm 17x15EV Z.20		Art. 15051	OEM Cuscinetto Reggispinta	
				Art. 15359	OEM Manicotto completo di molla				
MASTERMEC L2 - R2 - S2 - L30 MOTOAGRICOLA MAJORMEC (1ª SERIE)	Art. 15012	OEM Frizione monodisco con molle a diaframma Piatto Ø 180 mm		Art. 15031	OEM F0819134020 Disco frizione rigido 181x127x3,8 mm 23x20EV Z.20		Art. 15043	OEM Manicotto con cuscinetto reggispinta	
TRATTORINO 845	Art. 15515	OEM Frizione monodisco con molle a diaframma Piatto Ø 215 mm		Art. 15099	OEM Disco frizione rigido 215x152x3,8 mm 23x20EV Z.20		Art. 15043	OEM Manicotto con cuscinetto reggispinta	
MOTOZAPPA MINIFALCE	Art. 15710	OEM Frizione conica Ø 103x82,5 mm Albero Ø 23 Conicità 1:5 11x14x3 - Z.6							
MASTERMEC L2 - R2 - S2 - L30 MOTOAGRICOLA MAJORMEC (2ª SERIE)	Art. 15711	OEM Frizione monodisco con molle a diaframma Piatto Ø 180 mm		Art. 15031	OEM F0819134020 Disco frizione rigido 181x127x3,8 mm 23x20EV Z.20		Art. 15043	OEM Manicotto con cuscinetto reggispinta	

AEBI

TERATRAC TT40	Art. 15720	OEM Meccanismo a 3 leve completo di disco centrale in ferodo. Piatto Ø 180 mm		Art. 15721	OEM Disco frizione rigido centrale 180x127x3,8 mm 35x31 mm - Z.18		Art. 15707	OEM Disco PTO in ferodo 180x127x3,8 mm 20x17 mm - Z.12	
---------------	-------------------	---	---	-------------------	--	---	-------------------	---	---

AGRIFULL RUOTE

TRATTORI 68-78 E DERIVATI	Art. 15149	OEM Frizione monodisco a molle elicoidali Piatto Ø 215 mm		Art. 15325	OEM Disco frizione rigido 216x152x3,8 mm 26x21x4 Z.10		Art. 15055	OEM Cuscinetto Reggispinta	
				Art. 15049	OEM Manicotto				
(segue AGRIFULL RUOTE)									



























Frizioni e loro componenti

CLUTCHES - CLUTCH DISK - BEARING - COUPLING - LEVER - SET-REVISION



















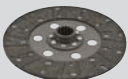











11

11

segue AGRIFULL RUOTE

<p>JOLLY 50 TOSELLI 60-70-85 DERBY 60-80 GRISO 70-75 TORNADO 80 8045 - 8050 - 8055 8060 - 55.46 - 65.46 RODEO 90 - 90</p> <p>1ª serie - Fino al 1976</p>	<p>Art. Kit 15976</p> 		<p>OEM 87689657 Kit composto da: - Meccanismo 15544 - Disco PTO 15943 - Cuscinetti 15990 - 63896 - 63867</p>
	<p>Art. 15544</p>  <p>OEM 5145706 - 5154879 - 5171137 - Meccanismo a 6 leve completo di disco centrale in ferodo senza il disco PTO. - Piatto Ø 280 mm (11")</p>	<p>Art. 15943</p>  <p>OEM 5145715 - 5154703 Disco PTO rigido in ferodo 280x165x3 mm 25x22EV - Z.10</p>	<p>Art. 15520</p>  <p>OEM 5145715 - 5154703 Disco PTO rigido in ferodo 280x165x3 mm 25x22EV - Z.10</p>
	<p>Art. 15147</p>  <p>OEM 5171053 - 5155304 Disco centrale in ferodo con molle parastrappi 280x165x4,4 mm 40x35EV - Z.14</p>	<p>Art. 15990</p>  <p>OEM 5119290 5119875 - 5122028 Cuscinetto reggispinta cambio 90x50x22 mm</p>	<p>Art. 15280</p>  <p>OEM 5119290 - 5119875 - 5122028 - 87345759 Cuscinetto reggispinta cambio 90x50x22 mm</p> <p>Nuova Versione OEM 5197980</p> <p>Art. 15800</p>
	<p>Art. 16167</p>  <p>OEM 4993817 Collare</p>	<p>Art. 62951</p>  <p>OEM 24905360 - 84455696 Cuscinetto reggispinta PTO 70x110x20 mm</p> <p>Art. FAG 63896</p>	<p>Art. 62581</p>  <p>OEM 28043280 Cuscinetto volano 17x47x14 mm</p> <p>Art. FAG 63867</p>
<p>JOLLY 50 TOSELLI 60-70-85 DERBY 60-80 GRISO 70-75 TORNADO 80 8045 - 8050 - 8055 8060 - 8075 RODEO 90 - 90 60II - 70II - 80II - 466 - 450S - 480 - 500 - 530 - 540 - 566 - 570 - 580 - 600 - 640 - 666 - 670</p> <p>2ª serie - Rinforzata</p> <p>MECCANISMO RINFORZATO</p> <p>N.B.: Quando si sostituisce un meccanismo non rinforzato con un meccanismo rinforzato, bisogna sostituire anche il disco PTO.</p> <p>(segue AGRIFULL RUOTE)</p>	<p>Art. Kit 15929</p> 		<p>OEM</p> <p>Kit composto da: - Meccanismo 15505 - Disco PTO 15943</p>
	<p>Art. Kit 15938</p> 		<p>OEM</p> <p>Kit composto da: - Meccanismo 15505 - Disco PTO 15943 - Cuscinetti 15990 - 63896 - 63867</p>
	<p>Art. 15505</p>  <p>OEM 5162900-5150652 Meccanismo a 6 leve completo di disco centrale metalceramico a 6 pale senza il disco PTO. Piatto Ø 280 mm (11") Intercambiabile con meccanismo VALEO</p>	<p>Art. 15943</p>  <p>OEM 5145715 - 5154703 Disco PTO rigido in ferodo 280x165x3 mm 25x22EV - Z.10</p>	<p>Art. 15520</p>  <p>OEM 5145715 - 5154703 Disco PTO rigido in ferodo 280x165x3 mm 25x22EV - Z.10</p>
	<p>Art. 15414</p>  <p>OEM 5145711 Disco centrale metalceramico a 5 pale con molle parastrappi Ø 280 mm sinterizzato 40x35EV - Z.14</p> <p>Tipo SILA intercambiabile con LUK</p>	<p>Art. 15528</p>  <p>OEM 5162901 Disco centrale metalceramico a 6 pale con molle parastrappi per meccanismo 15505 Ø 280 mm sinterizzato 40x35EV - Z.14</p>	<p>Art. 15523</p>  <p>OEM 5156209 Disco centrale in ferodo con molle parastrappi 280x165x3,5 mm 40x35EV - Z.14</p>
	<p>Art. 15990</p>  <p>OEM 5119290 5119875 - 5122028 - 87345759 Cuscinetto reggispinta cambio 90x50x22 mm</p>	<p>Art. 15280</p>  <p>OEM 5119290 - 5119875 - 5122028 - 87345759 Cuscinetto reggispinta cambio 90x50x22 mm</p> <p>Nuova Versione OEM 5197980</p> <p>Art. 15800</p>	<p>Art. 62581</p>  <p>OEM 28043280 Cuscinetto volano 17x47x14 mm</p> <p>Art. FAG 63867</p>
	<p>Art. 16167</p>  <p>OEM 4993817 Collare</p>	<p>Art. 15863</p>  <p>OEM 599930 Cuscinetto reggispinta</p>	<p>Art. 62951</p>  <p>OEM 24905360 - 84455696 Cuscinetto reggispinta PTO 70x110x20 mm</p> <p>Art. FAG 63896</p>
	<p>Art. 15862</p>  <p>OEM 5103178 Cuscinetto reggispinta</p>	<p>Art. 15751</p>  <p>OEM 26794570 Cuscinetto PTO 65x100x11 mm Per mod: 480S-500S-540S-550-600-640</p>	

segue AGRIFULL RUOTE

8065 - 8066	Art. Kit 15975      	OEM 87689655 Kit composto da: - Meccanismo 15529 - Disco PTO 15943 - Cuscinetti 15990 - 63896 - 63867
Art. 15529  OEM 5154835 Meccanismo a 6 leve completo di disco centrale rigido in ferodo. Fornito senza il disco PTO. Piatto Ø 280 mm (11") Intercambiabile con meccanismo VALEO	Art. 15943  OEM 5145715 - 5154703 Disco PTO rigido in ferodo 280x165x3 mm 25x22EV - Z.10	Art. 15520  OEM 5145715 - 5154703 Disco PTO rigido in ferodo 280x165x3 mm 25x22EV - Z.10
Art. 15631  OEM 5145714 - 5155300 Disco centrale rigido in ferodo 280x165x4,4 mm 40x35EV - Z.14	Art. 15990  OEM 5119290 5119875 - 5122028 - 87345759 Cuscinetto reggispinta cambio 90x50x22 mm	Art. 15280  OEM 5119290 - 5119875 - 5122028 - 87345759 Cuscinetto reggispinta cambio 90x50x22 mm Art. 15800 Nuova Versione OEM 5197980
	Art. 62951  OEM 24905360 - 84455696 Cuscinetto reggispinta PTO 70x110x20 mm Art. FAG 63896	Art. 62581  OEM 28043280 Cuscinetto volano 17x47x14 mm Art. FAG 63867
8085 - 8095 80105	Art. Kit 15932   	Kit composto da: - Meccanismo 15530 - Disco PTO 15966
MECCANISMO RINFORZATO N.B.: Quando si sostituisce un meccanismo non rinforzato con un meccanismo rinforzato, bisogna sostituire anche il disco PTO.	Art. Kit 15978      	OEM Kit composto da: - Meccanismo 15530 - Disco PTO 15966 - Cuscinetti 15990 - 63897 - 63869
Art. 15530  OEM 5163936 Meccanismo a 6 leve completo di disco centrale metalceramico a 7 pale. Fornito senza il disco PTO. Piatto Ø 310 mm (12") Intercambiabile con meccanismo VALEO	Art. 15966  OEM 5144741 - 5154514 Disco PTO rigido in ferodo, per meccanismo 15530 310x190x3 mm 28x24EV - Z.10	Art. 15532  OEM 5144741 - 5154514 Disco PTO rigido in ferodo, per meccanismo 15530 310x190x3 mm 28x24EV - Z.10
Art. 15531  OEM 5163937 Disco centrale metalceramico rigido a 7 pale per meccanismo 15530 Ø 310 sinterizzato (12") 45x40EV - Z.16	Art. 15990  OEM 5119290 5119875 - 5122028 Cuscinetto reggispinta cambio 90x50x22 mm	Art. 15280  OEM 5119290 - 5119875 - 5122028 - 87345759 Cuscinetto reggispinta cambio 90x50x22 mm Art. 15800 Nuova Versione OEM 5197980
	Art. 62952  OEM 5112084 - 47127081 Cuscinetto reggispinta PTO 75x115x20 mm Art. FAG 63897	Art. 62583  OEM 28042740 Cuscinetto volano 20x47x14 mm Art. FAG 63869







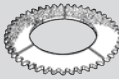
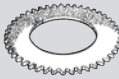

Frizioni e loro componenti

CLUTCHES - CLUTCH DISK - BEARING - COUPLING - LEVER - SET-REVISION





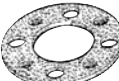
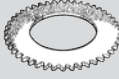

11

11







AGRIFULL CINGOLI

C80.50	Art. 15173  OEM 588433 - 5160719 Anello frizione centrale con dentatura esterna 277x156x10 mm (1/3T) - 45 denti	Art. 15176  OEM 5109937 - 5109934 - 5161615 Anello frizione di sterzo in tessuto con dentatura esterna 239x180x4,8 - 28 denti	Art. 15389  OEM 566519 Anello frizione di sterzo con dentatura interna 229x171x2 mm 21 denti
	Art. 15388  OEM 571707 - 5160601 Anello frizione cambio a 8 fori 88x48x4,5 mm		
C80-70 SPECIAL	Art. 15177  OEM 596511 - 5160602 Anello frizione centrale con dentatura esterna 277x166x7 mm 45 denti	Art. 15176  OEM 5109937 - 5109934 - 5161615 Anello frizione di sterzo in tessuto con dentatura esterna 239x180x4,8 - 28 denti	Art. 15389  OEM 566519 Anello frizione di sterzo con dentatura interna 229x171x2 mm 21 denti
	Art. 15388  OEM 571707 - 5160601 Anello frizione cambio a 8 fori 88x48x4,5 mm		
55 CV - CF - 60 C - CL - 70 C - CL - 80 C - C 80.46 - C 80.56 - C 80.66 - C 80.76	Art. 15176  OEM 5109937 - 5109934 - 5161615 Anello frizione di sterzo in tessuto con dentatura esterna 239x180x4,8 - 28 denti		Art. 15389  OEM 566519 Anello frizione di sterzo con dentatura interna 229x171x2 mm 21 denti





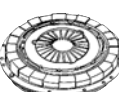









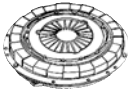









ARBOS MIETITREBBIE

1000 MAYOR	Art. 15234  OEM 16295 Disco frizione rigido in ferodo 250x155x4,3 mm 35x29x5,5 mm - Z.10	Art. 15365  OEM 541743 Cuscinetto reggispinta	Art. 15364  OEM 4561428 Manicotto
REKORD SUPEREKORD 1220 - 120 - 125 PANTERA - LINCE GIAGUAR - 165 TIGRE	Art. 15169  OEM R3731 - B46575 Disco frizione rigido in ferodo 279x171x4,3 mm 35x29x5,5 mm - Z.10	Art. 15365  OEM 541743 Cuscinetto reggispinta	Art. 15364  OEM 4561428 Manicotto

BARBIERI

MOTOCOLTIVATORI: GAZZELLA - PUMA 2ª SERIE	Art. 15588  OEM Frizione monodisco con molle a diaframma Piatto Ø 90 mm	Art. 15525  OEM Disco frizione rigido in ferodo 86x50x3,5 mm 15x12EV Z.8	Art. 15763  OEM Disco frizione rigido in ferodo 89x55x11 mm 15x12EV - Z.8 Ricambio per frizione 15588
			Art. 15042  OEM Manicotto con cuscinetto reggispinta
MOTOCOLTIVATORI: GAZZELLA - PUMA CON MOTORE JLO (segue BARBIERI)	Art. 15590  OEM Frizione monodisco con molle a diaframma Piatto Ø 90 mm	Art. 15525  OEM Disco frizione rigido in ferodo 86x50x3,5 mm 15x12EV - Z.8	Art. 15042  OEM Manicotto con cuscinetto reggispinta

segue **BARBIERI**

MOTOCOLTIVATORI: GAZZELLA - PUMA FB serie 310 - 900	Art. 15321	OEM Frizione monodisco con molle a diaframma Piatto Ø 95 mm		Art. 15189	OEM Disco frizione rigido in ferodo 94x61x1,5 mm 15x12EV Z.8		Art. 15042	OEM Manicotto con cuscinetto reggispinta	
				Art. 15050	OEM Cuscinetto reggispinta		Art. 15056	OEM Leva a forcella	
MOTOCOLAPPE: ZEBRA - FB serie 210	Art. 15002	OEM Frizione monodisco con molle a diaframma Piatto Ø 110 mm		Art. 15019	OEM Disco frizione rigido in ferodo 110x58x1,5 mm 15x12EV Z.8		Art. 15042	OEM Manicotto con cuscinetto reggispinta	
				Art. 15050	OEM Cuscinetto reggispinta		Art. 15057	OEM Leva a forcella	
MOTOCOLTIVATORI: GIAGUARO - Serie 1600	Art. 15339	OEM Frizione bidisco completa di disco centrale Piatto Ø 110 mm		Art. 15022	OEM Disco frizione rigido in sinterizzato Ø 110 mm sinterizzato 15x12EV Z.8		Art. 15042	OEM Manicotto con cuscinetto reggispinta	
				Art. 15050	OEM Cuscinetto reggispinta		Art. 15058	OEM Leva a forcella	
MOTOCOLTIVATORI: PIONEER - LEOPARD - FB serie 1400	Art. 15004	OEM Frizione monodisco a molle elicoidali Piatto Ø 160 mm		Art. 15025	OEM Disco frizione rigido in ferodo 160x110x3,8 mm 19x15,5x3 mm Z.10		Art. 15059	OEM Leva a forcella	
	Art. 15051	OEM Cuscinetto reggispinta		Art. 15048	OEM Manicotto				
MOTOCOLTIVATORI: MOTOFALCIATRICI	Art. 15610	OEM Frizione Ø 103x70,5 mm a dischi multipli con 4 dischi 15x12EV Z.8 Albero Ø23 mm					Art. 15629	OEM Manicotto con cuscinetto reggispinta	
MOTOCOLTIVATORI: REKORD (fino al 2004)	Art. 15608	OEM Disco frizione rigido in ferodo 122x80x11,5 mm 28x25EV Z.15							
MOTOCOLTIVATORI: REKORD (dal 2005)	Art. 15823	OEM Frizione monodisco Ø 142x92 mm 15x12 mm Z.8 Albero Ø 23 mm		Art. 15824	OEM Disco frizione rigido in ferodo 116x80x11,5 mm 28x25 mm DIN 5482 Z.15				

(segue BARBIERI)















Frizioni e loro componenti

CLUTCHES - CLUTCH DISK - BEARING - COUPLING - LEVER - SET-REVISION









11

11











segue BARBIERI

TRATTORINI: PANTHER DELFINO FB serie 1800	Art. 15005 	OEM Frizione monodisco a molle elicoidali Piatto Ø 187 mm	Art. 15026 	OEM Disco frizione rigido in ferodo 184x127x3,8 mm 19x15,5x3 mm - Z.10	Art. 15060 	OEM Leva a forcella
	Art. 15051 	OEM Cuscinetto reggispinta	Art. 15047 	OEM Manicotto		
TRATTORINI: FURIA FB serie 3500 (2-4 RM)	Art. 15006 	OEM Frizione monodisco a molle elicoidali Piatto Ø 187 mm	Art. 15035 	OEM Disco frizione rigido in ferodo 181x127x3,3 mm 22x19EV - Z.13	Art. 15060 	OEM Leva a forcella
	Art. 15052 	OEM Cuscinetto reggispinta 68x36x19 mm	Art. 15047 	OEM Manicotto		
TRATTORINI: FURIA FB serie 3500 (4 RM)	Art. 15297 	OEM Frizione monodisco a molle elicoidali Piatto Ø 216 mm	Art. 15191 	OEM Disco frizione rigido in ferodo 216x152x4 mm 22x19EV - Z.13	Art. 15061 	OEM Leva a forcella
	Art. 15052 	OEM Cuscinetto reggispinta 68x36x19 mm	Art. 15047 	OEM Manicotto		



BCS

MOTOCOLTIVATORI E MOTOFALCIATRICI SERIE 600/700	Art. 15001 	OEM 592.48106 Frizione conica Ø 103x100 mm Albero 22,5 mm Conicità 1:5 12x15EV - Z.8			
	Art. 15527 	Frizione Ø 103x99 mm a dischi multipli con 5 dischi 12x15EV - Z.8 Albero Ø23	Art. 15584 	OEM Serie dischi completa - composta da 5 dischi di Ø 93 mm	
MOTOCOLTIVATORI 705	Art. 15016 	OEM 581010076 Frizione monodisco a molle elicoidali Piatto Ø 155 mm	Art. 15032 	OEM 581010091 Disco frizione rigido 155x114x4,5 mm 16x13x3,5 mm - Z.6	
	Art. 15051 	OEM 581010102 Cuscinetto reggispinta			
MOTOCOLTIVATORE MOTOFALCIAT. 720 (per sostituzione autoventilante)	Art. 15825 	OEM Frizione Ø 103x113,5 mm a dischi multipli con 4 dischi 12x15EV - Z.8 Albero Ø23	Art. 15630 	OEM Disco frizione sinterizzato Ø 93 mm	
MOTOFALCIATRICI E MOTOCOLTIVATORI 715 - 735 (segue BCS)	Art. 15001 	OEM 592.48106 Frizione conica Ø 103x100 mm Albero Ø 22,5 mm Conicità 1:5 15x12EV - Z.8			





segue BCS

MOTOFALCIATRICE 622	Art. 15328 	OEM 590024260 Disco frizione rigido 178x133x5 mm 25x20EV - Z.15		
MOTOCOLTIVATORE 745 (motore Lombardini 3LD510)	Art. 15747 	OEM 59247513 Frizione Ø 103x104 a dischi multipli con 5 dischi 12x15 mm - Z.8 albero Ø 24 mm filetto M16x1,5	Art. 15584 	OEM Serie dischi completa - composta da 5 dischi di Ø 93 mm
VICTOR 300 AR - 400L AR	Art. Kit 16082  		OEM 58172957 - 59978097 Kit meccanismo più disco frizione. Piatto Ø 180 mm 17x15 - Z.20	
INVICTUS K400	Art. 15720 	OEM Meccanismo a 3 leve completo di disco centrale in ferodo. Piatto Ø 180 mm	Art. 15707 	OEM Disco PTO in ferodo 180x127x3,8 mm 20x17 mm - Z.12
			Art. 15272 	OEM Cuscinetto reggispinta piccolo 82x50x28
MATRA 101	Art. 15298 	OEM 599.25834 Frizione monodisco con molle a diaframma Piatto Ø 160 mm	Art. 15312 	OEM 599.25837 Disco frizione con molle parastrappi 155x114x3 mm 17x15EV - Z.20
			Art. 15807 	OEM Cuscinetto reggispinta cambio 82x50x26

BEDOGNI

MOTOFALCIATRICE E MOTOCOLTIVATORE COLIBRI	Art. 15019 	OEM 60053 Disco frizione rigido 110x58x1,5 mm 15x12EV - Z.8		
MOTOCOLTIVATORI COLIBRI	Art. 15022 	OEM Disco rigido sinterizzato 110x75x3 mm 15x12EV - Z.8		
MOTOFALCIATRICE OLIMPIA	Art. 15153 	OEM 12231 Disco frizione rigido 178x133x2,8 mm 23x18x3 mm - Z.10		

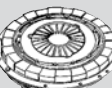
BENASSI MECCANICA

MOTOZAPPA RL 300 - SM (FRIZIONE CORTA)	Art. 15318 	OEM Frizione conica Ø 103x69 mm Albero Ø 22,5 Larghezza 66,5 mm Conicità 1:5 15x12EV - Z.8		
MOTOZAPPA RL 300 (FRIZIONE LUNGA)	Art. 15001 	OEM Frizione conica Ø 103x100 mm Albero Ø 22,5 Conicità 1:5 Larghezza 97,5 mm 15x12EV - Z.8		
MOTOZAPPA RL 95 - 100 - 634L MOTOCOLTIVATORI 421	Art. 15002 	OEM Frizione monodisco con molle a diaframma Piatto Ø 110 mm	Art. 15019 	OEM Disco frizione rigido 110x58x1,5 mm 15x12EV - Z.8

Frizioni e loro componenti

CLUTCHES - CLUTCH DISK - BEARING - COUPLING - LEVER - SET-REVISION



11

11









segue BENASSI MECCANICA

MOTAZAPPA RL309 MOTOCOLTIVATORI 419	Art. 15611 	OEM Disco frizione rigido sinterizzato 82x60x2 mm 50x45EV - Z.24		
---	--	--	--	--













BENASSI SPA

MOTAZAPPA BL 105	Art. 15519 	OEM Frizione conica Ø 103x90 mm Albero 22,5 mm Conicità 1:5 14x11x3 - Z.6		
MOTAZAPPA 10 HP - BL105 MOTOFALCIATRICE	Art. 15521 	OEM Frizione Ø 103x90 mm a dischi multipli con 4 dischi 14x11x3 mm Z.6 Albero Ø23		

BERTOLINI

MOTOCOLTIVATORI SERIE 300	Art. 15160 	OEM 81.9024.00 Disco frizione rigido 80x60x2,3 mm 20x17EV Z.12		
MOTOFALCIATRICI BRF 58	Art. 15193 	OEM 81.9030.00 Disco frizione rigido 145x102x4 mm 26x21x3 mm Z.10		
MOTOFALCIATRICI 124 - 125 - 126	Art. 15194 	OEM 81.9036.00 Disco frizione rigido 178x134x2,5 mm 26x21x3 mm Z.10		
MOTOCOLTIVATORI 305	Art. 15002 	OEM 81.9220.00 Frizione monodisco con molle a diaframma Piatto Ø 110 mm	Art. 15019 	OEM 81.9221.00 Disco frizione rigido 110x58x1,5 mm 15x12EV Z.8
	Art. 15042 	OEM 81.9222.00 Manicotto con cuscinetto reggispinta	Art. 15057 	OEM 81.9218.00 Leva a forcella
MOTOCOLTIVATORI SERIE 307 (FRIZIONE LUNGA)	Art. 15001 	OEM Frizione conica Ø 103x100 mm Albero Ø 23 mm Conicità 1:5 Larghezza 97,5 mm 12x15EV - Z.8		
MOTOCOLTIVATORI SERIE 307 - 406 (FRIZIONE CORTA) MOTOFALCIATRICE 134-140 (segue BERTOLINI)	Art. 15533 	OEM120003 Frizione conica Ø 103x87 mm Albero Ø 22,5 mm Conicità 1:5 15x12EV - Z.8		

segue BERTOLINI

MOTOFALCIATRICE SERIE 136 - 312 - 408	Art. 15633 	OEM Frizione Ø 103x87 mm a dischi multipli con 4 dischi 12x15EV - Z.8 Albero Ø23 mm Conicità 1:5		
MOTOFALCIATRICE CON MOTORE ACME AT 330 - ALN 330	Art. 15585 	OEM Frizione Ø 103x87 mm a dischi multipli con 4 dischi 12x15EV - Z.8 Albero Ø 23 mm Conicità 1:5 Vite lunga		
MOTOCOLTIVATORI: BM 10 310 (1ª serie) 324 (1ª serie)	Art. 15195 	OEM 81.9056.00 Disco frizione rigido 155x114x1,5 mm 22x18x3,5 mm Z.10	Art. 15044 	OEM Manicotto con anello in grafite
MOTOCOLTIVATORI: BM 310 310 (2ª serie) 324 (2ª serie)	Art. 15196 	OEM 81.9085.00 Disco frizione rigido 160x110x3,8 mm 22x19EV Z.13		
MOTOCOLTIVATORI: 310 S TRATTORINI 310T - 510	Art. 15013 	OEM 81.9109.20 Frizione monodisco con molle a diaframma Piatto Ø 160 mm	Art. 15029 	OEM 81.9112.00 Disco frizione rigido 160x110x3,8 mm 23x20EV Z.20
	Art. 15043 	OEM 81.9134.30 Manicotto con cuscinetto reggispinta		
MOTOCOLTIVATORI 315	Art. 15003 	OEM 81.9032.00 Frizione monodisco con molle elicoidali Piatto Ø 140 mm	Art. 15020 	OEM 81.9033.00 Disco frizione rigido 140x96x3,2 mm 17x15EV Z.20
	Art. 15044 	OEM Manicotto con anello in grafite		
MOTOCOLTIVATORI: 318 (segue BERTOLINI)	Art. 15013 	OEM 81.9109.20 Frizione monodisco con molle a diaframma Piatto Ø 160 mm	Art. 15198 	OEM 81.9134.30 Manicotto con cuscinetto reggispinta



















Frizioni e loro componenti

CLUTCHES - CLUTCH DISK - BEARING - COUPLING - LEVER - SET-REVISION

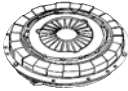
11









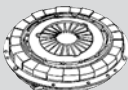

11

segue BERTOLINI

MOTOCOLTIVATORI 320	Art. 15330  OEM 81.9117.00 Frizione monodisco con molle a diaframma Piatto Ø 180 mm	Art. 15035  OEM 81.9119.00 Disco frizione rigido 181x127x4 mm 22x19EV Z.13	Art. 15061  OEM 81.9127.00 Leva a forcella
	Art. 15054  OEM Cuscinetto reggispinta	Art. 15046  OEM Manicotto	
TRATTORINI 330	Art. 15331  OEM 81.9301.00 Frizione monodisco con molle a diaframma Piatto Ø 180 mm	Art. 15035  OEM 81.9119.00 Disco frizione rigido 181x127x4 mm 22x19EV Z.13	
	Art. 15332  OEM 81.9302.00 Manicotto con cuscinetto reggispinta	Art. 15333  OEM 81.9303.00 Leva a forcella	
MOTOCOLTIVATORI BM 12 - TRATTORINI 412T	Art. 15296  OEM 81.9003.00 Monodisco con molle elicoidali Piatto Ø 187 mm	Art. 15141  OEM 81.9006.00 Disco frizione rigido 184x127x3,8 mm 22x18x3,5 Z.10	
	Art. 15052  OEM Cuscinetto reggispinta 68x36x19 mm	Art. 15047  OEM 81.9009.00 Manicotto	
421 DIESEL 1C 424 - 431 - 432 - DIESEL 2C - 428 - 450	Art. 15012  OEM 81.9134.00 Frizione monodisco con molle a diaframma Piatto Ø 180 mm	Art. 15031  OEM 81.9134.20 Disco frizione rigido 181x127x3,8 mm 23x20EV Z.20	
	Art. 15043  OEM 81.9134.30 Manicotto con cuscinetto reggispinta		
450 DIESEL 3 CILINDRI	Art. 15014  OEM 81.9134.60 Frizione monodisco con molle a diaframma Piatto Ø 180 mm	Art. 15031  OEM 81.9134.20 Disco frizione rigido 181x127x3,8 mm 23x20EV Z.20	
	Art. 15043  OEM 81.9134.30 Manicotto con cuscinetto reggispinta		

(segue BERTOLINI)

segue BERTOLINI

TRATTORINI 530	 Art. 15338	OEM 81.9143.00 Frizione monodisco con molle a diaframma Piatto Ø 215 mm	 Art. 15191	OEM 81.9144.20 Disco frizione rigido 216x152x4 mm 23x19EV - Z.13	
	 Art. 15332	OEM 81.9302.00 Manicotto con cuscinetto reggispinta	 Art. 15333	OEM 81.9303.00 Leva a forcella	
MOTOCOLTIVATORI SERIE 406 (MOTORE ACME ALN 330)	 Art. 15632	OEM Frizione conica Ø 103x87 mm Perno lungo Albero Ø 22,5 mm Conicità 1:5 - Vite lunga 15x12EV - Z.8			
MOTOCOLTIVATORI SERIE 406 (MOTORE HONDA/ B&S)	 Art. 15713	OEM Frizione conica Ø 103x84,5 mm Albero 19,5 mm 15x12 Z.8			
MOTOFALCIATRICE SERIE 408 (MOTORE B&S)	 Art. 15714	OEM Frizione Ø 103x130,5 mm albero 25,4 mm a dischi multipli con 4 dischi 15x12 - Z.8	 Art. 15630	OEM Disco frizione sinterizzato Ø 93 mm	
MOTOFALCIATRICE SERIE 408 (MOTORE HONDA)	 Art. 15826	OEM Frizione Ø 103x131 mm a dischi multipli con 4 dischi 12x15EV - Z.8 Albero Ø 25,4 mm	 Art. 15630	OEM Disco frizione sinterizzato Ø 93 mm	
MOTOFALCIATRICE M 141 (Frizione di sterzo)	 Art. 15827	OEM Frizione Ø 103x96 mm a dischi multipli con 8 dischi 25x22 - Z.14			

Frizioni e loro componenti

CLUTCHES - CLUTCH DISK - BEARING - COUPLING - LEVER - SET-REVISION





11

11



BERTOLINI - YABE - EMAX - CAMBIO NIBBI D.

MOTOCOLTIVATORE 401/402/403 ATTENZIONE: Vite fissaggio corta	Art. 15828 	OEM Frizione Ø 100x75 mm a 3 dischi 12x15EV - Z.8 Albero Ø 23 mm		
MOTOCOLTIVATORE 401/402/403 (motore HONDA G x160)	Art. 15829 	OEM Frizione Ø 100x104 mm a 3 dischi 12x15EV - Z.8 Albero Ø 19,05 mm		
MOTOCOLTIVATORE 401/402/403 (motore HONDA G c160)	Art. 15830 	OEM Frizione Ø 100x90 mm a 3 dischi 12x15EV - Z.8 Albero Ø 19,05 mm		
MOTOCOLTIVATORE 401/402/403 (motore ALN 330) ATTENZIONE: Vite fissaggio lunga	Art. 15831 	OEM Frizione Ø 100x75 mm a 3 dischi 12x15EV - Z.8 Albero Ø 23 mm		
MOTOCOLTIVATORE 401/402/403 (motore ROBYN EY20)	Art. 15832 	OEM Frizione Ø 100x104 mm a 3 dischi 12x15EV - Z.8 Albero Ø 19,05 mm		
MOTOCOLTIVATORE 401/402/403 (motore HONDA)	Art. 15833 	OEM Frizione Ø 100x105 mm a 3 dischi 12x15EV - Z.8 Albero Ø 20 mm		











BMW

MOTOZAPPA	Art. 15318 	OEM Frizione conica Ø 103x69 mm Albero Ø 22,5 mm Conicità 1:5 15x12EV - Z.8		
MOTOZAPPA	Art. 15587 	OEM Frizione conica Ø 103x91 mm Albero Ø 22,5 mm Conicità 1:5 15x12EV - Z.8		
MOTOZAPPA	Art. 15339 	OEM Frizione bidisco con molle a diaframma - completa di disco centrale Piatto Ø 110 mm	Art. 15019  OEM Disco frizione rigido in ferodo 110x58x3 mm 15x12EV Z.8	Art. 15042  OEM Manicotto con cuscinetto reggispinta

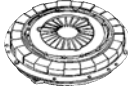

BRUMITAL

MOTOZAPPE SIMPLEX (segue BRUMITAL)	Art. 15588 	OEM Frizione monodisco con molle a diaframma Piatto Ø 90 mm	Art. 15525  OEM Disco frizione rigido in ferodo 86x50x3,5 mm 15x12EV Z.8 Ricambio per frizione PI-VI	Art. 15763  OEM Disco frizione rigido in ferodo 89x55x11 mm 15x12EV Z.8 Ricambio per frizione 15588
--	--	--	--	---











segue BRUMITAL

MOTOZAPPE SIMPLEX	 Art. 15321	OEM Frizione monodisco con molle a diaframma Piatto Ø 95 mm 15x12 Z.8	 Art. 15189	OEM Disco frizione rigido 94x61x1,5 mm 15x12EV Z.8	
	 Art. 15050	OEM Cuscinetto reggispinta	 Art. 15042	OEM Manicotto con cuscinetto reggispinta	
MOTOZAPPE	 Art. 15002	OEM Frizione monodisco con molle a diaframma Piatto Ø 110 mm	 Art. 15022	OEM Disco rigido sinterizzato 110x75x3 mm 15x12EV - Z.8	 Art. 15042 OEM Manicotto con cuscinetto reggispinta
MOTOZAPPE CON FRIZIONE DI Ø 110 MM SOTTOCHIOMA MULETTO	 Art. 15339	OEM Frizione bidisco Piatto Ø 110 mm	 Art. 15022	OEM Disco frizione sinterizzato Ø 110 mm 15x12EV - Z.8	
	 Art. 15050	OEM Cuscinetto reggispinta	 Art. 15042	OEM Manicotto con cuscinetto reggispinta	

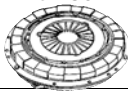
CAMISA

MOTOCOLTIVATORE	 Art. 15594	OEM Frizione conica Ø 103x99 mm Albero Ø 22,5 mm Conicità 1:5 15x12EV - Z.8			
MOTOCOLTIVATORE 10 HP	 Art. 15589	OEM Frizione Ø 103x99 mm a dischi multipli con 4 dischi 15x12EV - Z.8 Albero Ø23	 Art. 15630	OEM Disco frizione sinterizzato Ø 93 mm	

CARON

TRANSPORTER C 12	 Art. 15016	OEM Frizione monodisco con molle elicoidali Piatto Ø 155 mm	 Art. 15028	OEM Disco frizione rigido 160x112x3 mm 17x15EV Z.20	
	 Art. 15051	OEM Cuscinetto reggispinta	 Art. 15048	OEM Manicotto	
TRANSPORTER MC 20 TA 42	 Art. 15014	OEM Frizione monodisco con molle a diaframma Piatto Ø 180 mm	 Art. 15031	OEM F0819134020 Disco frizione rigido 181x127x3,8 mm 23x20EV - Z.20	 Art. 15043 OEM Manicotto con cuscinetto reggispinta
TRANSPORTER MC 40	 Art. 15942	OEM Frizione monodisco con molle a diaframma rinforzate Piatto Ø 180 mm	 Art. 15031	OEM F0819134020 Disco frizione rigido 181x127x3,8 mm 23x20EV Z.20	 Art. 15043 OEM Manicotto con cuscinetto reggispinta















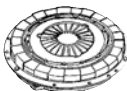











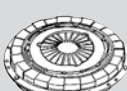







Frizioni e loro componenti

CLUTCHES - CLUTCH DISK - BEARING - COUPLING - LEVER - SET-REVISION

11

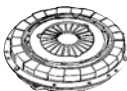
11



















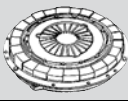

CARRARO ANTONIO

MOTOCOLTIVATORI SERIE 47 - 240 - 295 (2ª SERIE) 524 - 530	Art. 15588  OEM Frizione monodisco con molle a diaframma Piatto Ø90 mm	Art. 15525  OEM Disco frizione rigido in ferodo 86x50x3,5 15x12EV Z.8	Art. 15189  OEM Disco frizione rigido in ferodo 94x60x3,5 15x12EV Z.8	Art. 15763  OEM Disco frizione rigido in ferodo 89x55x11 15x12EV Z.8 per art. 15588
CARRARINO SERIE: MINI E SPECIAL	Art. 15002  OEM 5.107.502 Frizione monodisco con molle a diaframma Piatto Ø 110 mm	Art. 15019  OEM 5.108.501 Disco frizione rigido 110x58x1,5 mm 15x12EV Z.8	Art. 15066  OEM Leva a forcella	
	Art. 15050  OEM Cuscinetto reggispinta	Art. 15042  OEM Manicotto con cuscinetto reggispinta		
CARRARINO SERIE SUPER	Art. 15334  OEM 5107503 Frizione bidisco con disco frizione lato cambio inserito Piatto Ø 110 mm	Art. 15019  OEM 40211006 5108501 Disco frizione rigido 110x58x1,5 mm 15x12EV - Z.8	Art. 15066  OEM 6093501 Leva a forcella	
	Art. 15050  OEM Cuscinetto reggispinta	Art. 15042  OEM 47115003 Manicotto con cuscinetto reggispinta		
TIGRE 2800	Art. 15298  OEM 5.107.511 Frizione monodisco con molle a diaframma Piatto Ø 160 mm	Art. 15028  OEM 5.108.514 Disco frizione rigido in ferodo 160x112x3 mm 17x15EV - Z.20	Art. 15741  OEM 5073504 47115006 Manicotto con cuscinetto reggispinta	
TIGRE RS - TIGROTTO RS - TIGRE TRANSPORTER - TIGROTTO TRANSPORTER - TIGRE 2700	Art. 15298  OEM 5.107.511 Frizione monodisco con molle a diaframma Piatto Ø 160 mm	Art. 15312  OEM 5.108.516 Disco frizione con molle parastrappi 155x114x3 mm 17x15EV - Z.20	Art. 15741  OEM 5073504 47115006 Manicotto con cuscinetto reggispinta	
MOTOCOLTIVATORE TIGRE 282M SCARABEO	Art. 15715  OEM ZZ10366M - ZZ10381M/160 Frizione monodisco con molle elicoidali Piatto Ø 160 mm	Art. 15040  OEM Disco frizione rigido in ferodo 160x110x3,2 mm 22x19x3,5 - Z.10		
new TIGRE 2500 - 3100 - 3200 - 3800F - 4000- 4400F - TIGRE Country 3700 - 4300 TIGRETRAC 2500 - 3800 - 4400	Art. 16268  OEM 40210004 Frizione monodisco con molle elicoidali Piatto Ø 180 mm	Art. 16269  OEM 40211010 Disco frizione con molle parastrappi 181x17x15 mm Z.20	Art. 15741  OEM 5073504 47115006 Manicotto con cuscinetto reggispinta	
3400 SUPER TIGRE E TIGRONE - 3600 SUPER TIGRE E TIGRONE - 620 - 625 - 634 - 635 - SUPER TIGRE	Art. 15336  OEM 5107513 5.107.506 Frizione monodisco con molle a diaframma Piatto Ø 180 mm	Art. 15199  OEM 5.108.504 Disco frizione rigido 181x124x3,8 mm 22x18x3,5 mm - Z.10	Art. 15302  OEM 5073502 - 5073505 Manicotto con cuscinetto reggispinta Ø foro 33 mm	
4000 SUPER TIGRE - TIGRONE 620 - 625 - 635 - SUPER TIGRE (2ª SERIE)	Art. 15337  OEM 5107514 5.107.505 Frizione monodisco con molle a diaframma Piatto Ø 200 mm	Art. 15200  OEM 5108503 5.108.503 Disco frizione rigido 200x130x3,8 mm 22x18x3,5 mm - Z.10	Art. 15302  OEM 5073502 - 5073505 Manicotto con cuscinetto reggispinta Ø foro 33 mm	
SUPER TIGRE - TIGRONE 4800 - TIGRONE 4800 KING - TIGRONE 5000 - TIGRONE 6000 KING - SERIE 700 MODELLI VARI (segue CARRARO A.)	Art. 15338  OEM 5.107.504 Frizione monodisco con molle a diaframma Piatto Ø 215 mm	Art. 15201  OEM 5108502 Disco frizione rigido 215x145x3,8 mm 22x18x3,5 mm Z.10	Art. 15302  OEM 5073502 - 5073505 Manicotto con cuscinetto reggispinta Ø foro 33 mm	Art. 15740  OEM 5073505 Manicotto con cuscinetto reggispinta Ø foro 36 mm















Frizioni e loro componenti

CLUTCHES - CLUTCH DISK - BEARING - COUPLING - LEVER - SET-REVISION

segue CARRARO ANTONIO

TIGRONE 5500 - 7000 - 7700	 Art. 15656	OEM 40.21.0001 - 5107519 Frizione monodisco con molle a diaframma Piatto Ø 250 mm	 Art. 15156 OEM 40.21.1001 Disco frizione 250x145x3,8 mm 35x31 mm - Z.18 Con molle parastrappi	 Art. 15302 OEM 5073502 - Manicotto con cuscinetto reggispinta Ø foro 33 mm (NO PER 7000)	 Art. 15740 OEM 5073505 Manicotto con cuscinetto reggispinta Ø foro 36 mm (PER 7000)
			 Art. 15809 OEM 5108518 Disco frizione 250x155x3,5 mm 27x30 mm - Z.16 Con molle parastrappi (SOLO PER 7000)		
TIGRONE 7800 8400 9400 TGF 7400	 Art. 15439	OEM 40210005 Meccanismo con molle a diaframma Piatto Ø 280 mm	 Art. 15908 OEM 40211011 Disco frizione Ø 280 31x35 mm - Z.18	 Art. 16189	OEM 37115001 - 37115011 Cuscinetto reggispinta Ø foro 38 mm
3200 - 3800 4000 - 4200	 Art. 15337	OEM 5.107.505 Frizione monodisco con molle a diaframma Piatto Ø 200 mm	 Art. 15738 OEM Disco frizione 200x130x3,2 mm 35x31 mm - Z.18	 Art. 15302 OEM 5073502 - 5073505 Manicotto con cuscinetto reggispinta Ø foro 33	Art. 15740 OEM 5073505 Manicotto con cuscinetto reggispinta Ø foro 36 mm
3700 - 5200 - 5500	 Art. 15338	OEM 5.107.504 Frizione monodisco con molle a diaframma Piatto Ø 215 mm	 Art. 15739 OEM Disco frizione 215x145x3,2 mm 35x31 mm - Z.18 Con molle parastrappi	 Art. 15302 OEM 5073502 - 5073505 Manicotto con cuscinetto reggispinta Ø foro 33	Art. 15740 OEM 5073505 Manicotto con cuscinetto reggispinta Ø foro 36 mm
ERGIT MACH 2 MACH 4	 Art. Kit 16085	 	OEM 19930174 Kit meccanismo + disco PTO Ø 300 a 6 pale Z.18	 Art. 16189	OEM 37115001 - 37115011 Cuscinetto reggispinta Ø foro 38 mm
TIGRONE 5400 SUPER TIGRE 5500 SUPER TIGRE 7500 TRX 6500	 Art. 15656	OEM 40210001 Frizione monodisco con molle a diaframma Piatto Ø 250 mm	 Art. 15156 OEM 40211001 Disco frizione 250x145x3,8 mm 35x31 mm - Z.18 Con molle parastrappi	 Art. 16189	OEM 37115001 - 37115011 Cuscinetto reggispinta Ø foro 38 mm

CARRARO SPA - RUOTE

CARRO 335 - 400 - 445 - 500 CARRO II serie 300 - 350	 Art. 15355	OEM 70542 Disco rigido centrale 250x155x3,5 mm 28x23x6 mm - Z.6	 Art. 15356 OEM 70541 Disco rigido presa di forza 216x152x3,5 mm 48x42x8 mm - Z.8	 Art. 15759 OEM 83966 Disco frizione rigido 216x152x3,5 mm 30x26EV - Z.10
CARRO 450 - 502 - 504 - 3500 - 4500 - 5000 (DOPPIA FRIZIONE)	 Art. 15370	OEM 83967 Disco rigido centrale 250x155x3,5 mm 30x26EV - Z.10	 Art. 15375 OEM 83968 Disco rigido presa di forza 216x125x3,5 mm 48,5x42,5EV - Z.13	
CARRO 552 - 554 - 602 - 604 - 652 - 654 - 702 - 704 - 732 - 734 - 6000	 Art. 15376	OEM 91932 - 107245 Disco rigido centrale 280x165x3,5 mm 30x25EV - Z.10	 Art. 15377 OEM 88731 Disco rigido PTO 280x165x3,5 mm 48,5x42,5EV - Z.13	
68.2 - 68.4 - 78.2 - 78.4 - 88.2 - 88.4 - NUOVO OK: 620.2 - 620.4 - 720.2 - 720.4 - 820.2 - 820.4 - 844 - 920.2 - 920.4	 Art. 15806	OEM 120738 Frizione con disco PTO interno (15634) Piatto Ø 280 mm	 Art. 15376 OEM 107245-104809 Disco rigido centrale in ferodo 280x165x3,5 mm 30x25EV - Z.10	 Art. 15586 OEM 109700 - 107245 Disco centrale rigido metalceramico Ø 280 mm sinterizzato 30x25EV - Z.10
	 Art. 15634	OEM 104809 Disco PTO rigido in ferodo 280x165x3,5 mm 45,5x39,5EV - Z.14	 Art. 15280 OEM 104746 Cuscinetto reggispinta cambio 90x50x22 mm	 Art. 63363 OEM 027659 Cuscinetto PTO 100x65x18 mm
48.2 - 48.4 58.2 - 58.4	 Art. 15761	OEM 107247 Disco rigido centrale 260x160x3,8 mm 30x25EV - Z.10	 Art. 15760 OEM 107246 Disco PTO rigido in ferodo 260x160x3,5 mm 45,5x39,5EV - Z.14	

















Frizioni e loro componenti

CLUTCHES - CLUTCH DISK - BEARING - COUPLING - LEVER - SET-REVISION







11

11

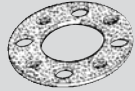

segue CARRARO SPA - RUOTE

4500 - 5000 - 6500 - 7000	Art. 15724 	OEM Frizione monodisco a molle elicoidali Piatto Ø 280 mm (solo per 4500-5000)	Art. 15762 	OEM 87912 Disco frizione rigido 280x172x3,5 mm 30x26EV - Z.10		
AGRIPLUS 65-75-85-95 AGRI-UP 50-50F-60-60F-60V-70-70F-70V-70-80F-80V 8.1000.4 8.1000.2 5.1000.4 5.1000.2	Art. Kit 16054      			OEM 207238 Kit composto da: - Meccanismo 15946 - Disco PTO 15873 - Cuscinetti 15990 - 63895 - 64536		
	Art. 15946 	Meccanismo a 6 leve completo di disco centrale metalceramico 34x40 mm - Z12 senza disco PTO Piatto Ø 280 (11") intercambiabile con OMG	Art. 15873 	OEM 199071 Disco PTO rigido in metalceramico. Ø 280 mm 22x19 mm - Z13	Art. 15948 	OEM 126004 Disco PTO rigido in ferodo. Ø 280 mm 22x19 mm - Z13
	Art. 15280 	OEM Cuscinetto reggispinta cambio 90x50x22 mm	Art. 63363 	OEM Cuscinetto PTO 100x65x18 mm	Art. FAG 64536 	OEM Cuscinetto volano 40x12x17 mm
N.B.: se si ordina il Kit 16054 per la serie 8.1000 e 5.1000 bisogna ordinare separatamente il manicotto reggispinta Art. CA104743	Art. LUK 15990 	OEM Manicotto reggispinta (solo per serie 8.1000 e 5.1000)	Art. FAG 63895 			

CARRARO SPA - CINGOLI











































450 C - 450 L - 455 C - 505 C - 555 C - 655 C - 6300 C	Art. 15388 	OEM 83793 Anello frizione cambio 88x48x4,5 mm 8 Fori	Art. 15389 	OEM 83702 Anello frizione sterzo 229x171x2 mm 21 denti Dentatura interna	Art. 15176 	OEM 83703 - 99425 Anello frizione di sterzo in tessuto 239x180x4,8 mm 28 denti esterni
3500 C - 4500 C	Art. 15173 	OEM 83779 Anello frizione centrale 277x156x10 mm (1/3 T)-45 denti esterni			Art. 15176 	OEM 83703-99425 Anello frizione di sterzo In tessuto - 239x180x4,8 mm 28 denti esterni
	Art. 15388 	OEM 83793 Anello frizione cambio 88x48x4,5 mm - 8 Fori	Art. 15389 	OEM 83702 Anello frizione sterzo 229x171x2 mm 21 denti interni		

CASE

SERIE 33: 533A - 540 - 633A - XE - XF - 640 - 740 - 733A (DAL MAGGIO 1978 IN AVANTI) 833A/E/H/V - 840 - 933 - 940	Art. Kit 16117      			OEM 1964054C1 Kit Frizione bidisco Ø 228/290 completo di: disco PTO rigido Ø 290 mm Z.13, cuscinetto 65x101,5x21,5 cuscinetto 80x137,5x41,5 cuscinetto 20x47x14		
	Art. 15546 	OEM 3224 545 R2 1964 054 C1 Meccanismo a 6 leve completo Piatto Ø 290 mm	Art. 15547 	OEM 1964 - 150 C1 Disco centrale metalceramico molleggiato a 6 pale Ø 290 sinterizzato-Z.13		
SERIE 55 - 56: 856XL - XLA - 955 XL - 956 XL - XLA - 1055 XL - 1056 XL - XLA	Art. 15550 	OEM 135 508 A1 3220 807 R3 Meccanismo Ø 310 a 6 leve completo di disco PTO Ø 310 a 5 pale 45x41 mm Z.22	Art. 15551 	OEM 1968 356 C1 3224.423 R91 Disco centrale metalceramico a 7 pale - Molleggiato Ø 310 mm sinterizzato Z.10	Art. 15862 	OEM 5103178 Cuscinetto reggispinta
	Art. 62952 	OEM 47127081 Cuscinetto reggispinta PTO 75x115x20 mm	Art. 64539 	OEM Cuscinetto volano		

(segue CASE)

segue CASE

SERIE 43 - 44: 724 (DAL MAGGIO 1978 IN AVANTI) - 734 - 743 - 744 - 745 - 754 - 824 - 834 - 844 - 845 - S/XL/XLA 523 - 553 - 554 - 564 - 624 - 644 - 654 - 724/XL/XLA - 734/XL/XLA - 743/XL/XLA - 744/XL/XLA - 745/S/XL/XLA - 754/XL/XLA - 824/S/XL/XLA - 834/S/XL/XLA - 844/S/XL/XLA/XLN - 845XL	Art. Kit 16118      		OEM Kit Frizione bidisco composto da: - Meccanismo 15548 - Disco PTO 15549 - Cuscinetti 15862 - 63897 - 63896			
	Art. 15548  	OEM 135 506 A1 1964 056 C1 Meccanismo a 6 leve \varnothing 280 - 41x45 - Z.22 completo di disco PTO ma senza disco centrale Piatto \varnothing 300 mm	Art. 15549  	OEM 1964 223 C1 3225.094 R1 3225.950 R1 Disco centrale metalceramico a 5 pale - Molleggiato - \varnothing 295 mm sinterizzato - Z.10	Art. 62952  	OEM Cuscinetto reggispinta PTO 75x115x20 mm Art. FAG 63897
			Art. 15862  	OEM 5103178 Cuscinetto reggispinta	Art. 62549  	OEM Cuscinetto volano 20x47x14 mm Art. FAG 63836
533/A - 540 - 633A/XE/XF - 733A - 740 - 833/A/E/H/V - 833/S/XL/XLA - 933	Art. 15546  	OEM 1964054EX Meccanismo a 6 leve completo Piatto \varnothing 290 mm	Art. 15547  	OEM Disco centrale metalceramico molleggiato a 6 pale \varnothing 290 sinterizzato-Z.13		
856XL - 955XL/XLA - 1055/XL - 1056XL -	Art. Kit 16120      		OEM Kit Frizione bidisco Kit composto da: - Meccanismo 15550 - Disco 15551 cuscinetto 65x102x25 cuscinetto 75x115x20 cuscinetto 20x47x14			
	Art. 15550  	OEM 47512419 Meccanismo \varnothing 310 a 6 leve completo di disco PTO \varnothing 310 a 5 pale 45x41 mm Z.22	Art. 15551  	OEM 1968 356 C1 3224.423 R91 Disco centrale metalceramico a 7 pale - Molleggiato \varnothing 310 mm sinterizzato Z.10		
1455 XL 1255 XL	Art. Kit 16119   	OEM 1964060C2 Kit composto da: - Meccanismo 15921 - Disco PTO 15922				
	Art. 15921  	OEM 1964060C1 3230985R98 Meccanismo \varnothing 350 mm con disco interno 44x48 Z.23	Art. 15922  	Art. 15799  	OEM Cuscinetto reggispinta 65x102x26 mm	
			Art. 62952  	OEM 47127081 Cuscinetto reggispinta PTO 75x115x20 mm Art. FAG 63897	Art. 62583  	OEM Cuscinetto volano 20x47x14 mm Art. FAG 63869

(segue CASE)













































Frizioni e loro componenti

CLUTCHES - CLUTCH DISK - BEARING - COUPLING - LEVER - SET-REVISION

11









































11

segue CASE

<p>JX 1075V</p>	<p>Art. Kit 16035</p>      			<p>OEM 73328271 Kit composto da: - Meccanismo 15793 - Disco PTO 15792 - Cuscinetti 15990 - 63897 - 63867</p>
	<p>Art. 15793</p>   <p>OEM 5196818-47134898 Meccanismo a 6 leve completo di disco centrale cerametallico 5 pale. Piatto Ø 280 mm 35x39,8 mm Z.14</p>	<p>Art. 15792</p>   <p>OEM 5176450 - 47134874 - 5196819 Disco PTO rigido in cerametallico 4 pale Ø 280 mm - 22x25 Z10</p>		
		<p>Art. 15990</p>   <p>OEM 5119290 5119875 - 5122028 Cuscinetto reggispinta cambio 90x50x22 mm</p>	<p>Art. 15280</p>  <p>OEM 5122028 87345759 Cuscinetto reggispinta cambio 90x50x22 mm</p>	
		<p>Art. 62952</p>  <p>OEM 47127081 Cuscinetto reggispinta PTO 75x115x20 mm</p> <p>Art. FAG 63897</p>	<p>Art. 62581</p>  <p>OEM 28043280 Cuscinetto volano 17x47x14 mm</p> <p>Art. FAG 63867</p>	
<p>AVJ 55/60/70 - JX 55/60/65/70</p>	<p>Art. 15544</p>   <p>OEM 47512408 - Meccanismo a 6 leve completo di disco centrale in ferodo senza il disco PTO. - Piatto Ø 280 mm (11")</p>	<p>Art. 15943</p>   <p>OEM Disco PTO rigido in ferodo 280x165x3 mm 25x22EV - Z.10</p>		
<p>JX90/95 FARMALL JX100/</p>	<p>Art. 15876</p>   <p>OEM 47618909 5092803 Meccanismo frizione a 6 leve con disco interno a 6 pale Z.16 Piatto Ø 310 mm (12")</p>	<p>Art. 15877</p>   <p>OEM 5089337 Disco frizione Ø 310 mm 22x25 mm - Z.10</p>	<p>Art. 62951</p>  <p>OEM 24905360 Cuscinetto reggispinta PTO 70x110x20 mm</p> <p>Art. FAG 63896</p>	
	<p>Art. 15990</p>   <p>OEM 5119290 5119875 - 5122028 Cuscinetto reggispinta cambio 90x50x22 mm</p>	<p>Art. 15280</p>  <p>OEM 5122028 Cuscinetto reggispinta cambio 90x50x22 mm</p>	<p>Art. 62581</p>  <p>OEM 28043280 Cuscinetto volano 17x47x14 mm</p> <p>Art. FAG 63867</p>	
<p>2140 - 2150 Serie 2000</p>	<p>Art. Kit 16054</p>      			<p>OEM Kit composto da: - Meccanismo 15946 - Disco PTO 15873 - Cuscinetti 15990 - 63895 - 54536</p>
	<p>Art. 15946</p>   <p>OEM Meccanismo a 6 leve completo di disco centrale metalceramico 34x40 mm - Z12 senza disco PTO Piatto Ø 280 (11") intercambiabile con OMG</p>	<p>Art. 15873</p>   <p>OEM Disco PTO rigido in metalceramico. Ø 280 mm 22x19 mm - Z13</p>	<p>Art. 15948</p>   <p>OEM Disco PTO rigido in ferodo. Ø 280 mm 22x19 mm - Z13</p>	
	<p>Art. 15280</p>   <p>OEM Cuscinetto reggispinta cambio 90x50x22 mm</p> <p>Art. LUK 15990</p>	<p>Art. 63363</p>  <p>OEM Cuscinetto PTO 100x65x18 mm</p> <p>Art. FAG 63895</p>	<p>Art. FAG 64536</p>  <p>OEM Cuscinetto volano 40x12x17 mm</p>	

(segue CASE)

segue CASE

JX 1070C/1075C/N/V 1085C/1095C/N/V QUANTUM 95C/F/N/V/ 105F/N	Art. Kit 16036      	OEM 87689675 Kit composto da: - Meccanismo 15796 - Disco PTO 15792 - Cuscinetti 15990 - 63897 - 63867				
	Art. Kit 15930   	OEM Kit composto da: - Meccanismo 15796 - Disco PTO 15792				
	Art. 15796  	OEM 87732504 5181421 - 5196813 - 47134895 - 87732503 - 87732506 Meccanismo a 6 leve completo di disco centrale cerametallico 6 pale Piatto Ø 280 mm 35x39,8 mm - Z.14	Art. 15990  	OEM 5119290 5119875 - 5122028 Cuscinetto reggispinta cambio 90x50x22 mm	Art. 15280 	OEM 5122028 87345759 Cuscinetto reggispinta cambio 90x50x22 mm
	Art. 15792  	OEM 5176450 - 47134874 - 5196819 Disco PTO rigido in cerametallico 4 pale Ø 280 mm - 22x25 Z10	Art. 62952 	OEM 47127081 Cuscinetto reggispinta PTO 75x115x20 mm	Art. 62581 	OEM 28043280 Cuscinetto volano 17x47x14 mm
JX 85/90 MECCANISMO RINFORZATO N.B.: Quando si sostituisce un meccanismo non rinforzato con un meccanismo rinforzato, bisogna sostituire anche il disco PTO.	Art. Kit 15929   	OEM 5092796 Kit composto da: - Meccanismo 15505 - Disco PTO 15943				
	Art. Kit 15938      	OEM Kit composto da: - Meccanismo 15505 - Disco PTO 15943 - Cuscinetti 15990 - 63896 - 63867				
	Art. 15505  	OEM Meccanismo a 6 leve completo di disco centrale metalceramico a 6 pale senza il disco PTO. Piatto Ø 280 mm (11") Intercambiabile con meccanismo VALEO	Art. 15943  	OEM Disco PTO rigido in ferodo 280x165x3 mm 25x22EV - Z.10	Art. 15520 	OEM Disco PTO rigido in ferodo 280x165x3 mm 25x22EV - Z.10
	Art. 15414 	OEM Disco centrale metalceramico a 5 pale con molle parastrappi Ø 280 mm sinterizzato 40x35EV - Z.14 Tipo SILA intercambiabile con LUK	Art. 15528 	OEM Disco centrale metalceramico a 6 pale con molle parastrappi per meccanismo 15505 Ø 280 mm sinterizzato 40x35EV - Z.14	Art. 15523 	OEM Disco centrale in ferodo con molle parastrappi 280x165x3,5 mm 40x35EV - Z.14
	Art. 15990  	OEM 5119875 - 5122028 Cuscinetto reggispinta cambio 90x50x22 mm	Art. 15280 	OEM 5119875 - 5122028 Cuscinetto reggispinta cambio 90x50x22 mm	Art. 62581 	OEM Cuscinetto volano 17x47x14 mm
					Art. 62951 	OEM Cuscinetto reggispinta PTO 70x110x20 mm

(segue CASE)

























Frizioni e loro componenti

CLUTCHES - CLUTCH DISK - BEARING - COUPLING - LEVER - SET-REVISION

11





































11

segue CASE

<p>JX 90/95/1070U/ 1080U/1090U/70U/ 80U/90U JXU 105/75/85/95/</p>	<p>Art. Kit 16056</p>  	<p>OEM</p> <p>Kit composto da: - Meccanismo 15786 - Disco PTO 15785 - Cuscinetti 15990 - 63867</p>				
	<p>Art. Kit 15981</p>  	<p>OEM</p> <p>Kit composto da: - Meccanismo 15786 - Disco PTO 15792 - Cuscinetti 15990 - 63896 - 63867</p>				
<p>Art. 15786</p> 	<p>OEM 84478095 Meccanismo a 6 leve completo di disco centrale cerametallico 6 pale senza il disco PTO Piatto Ø 310 mm</p>	<p>Art. 15792</p> 	<p>OEM Disco PTO rigido in cerametallico 4 pale Ø 280 mm - 22x25 Z10</p>	<p>Art. 15785</p> 	<p>OEM Disco PTO rigido in ferodo senza molleggio Ø 310 mm - 22x25 Z10</p>	
<p>Art. 62951</p> 	<p>OEM Cuscinetto reggispinta PTO 70x110x20 mm</p>	<p>Art. 15990</p> 	<p>OEM Cuscinetto reggispinta cambio 90x50x22 mm</p>	<p>Art. 15280</p> 	<p>OEM Cuscinetto reggispinta cambio 90x50x22 mm</p>	
		<p>Art. 62952</p> 	<p>OEM 47127081 Cuscinetto reggispinta PTO 75x115x20 mm</p>	<p>Art. 62581</p> 	<p>OEM Cuscinetto volano 17x47x14 mm</p>	
			<p>Art. FAG 63897</p>		<p>Art. FAG 63867</p>	
<p>JX 1060V/1070V/C/ 1075V/C/ 1085C/ 1095C/N/V JX 95 QUANTUM 105F/N/V/ 65C/N/75C/F/N/V/ 85C/F/N/V/95C/F/N/V</p>	<p>Art. 15797</p> 	<p>OEM 87590432 Meccanismo Piatto Ø 280 mm</p>	<p>Art. 15792</p> 	<p>OEM Disco PTO rigido in cerametallico 4 pale Ø 280 mm - 22x25 Z10</p>		
<p>JX 1060V/C/1070V/N - 1075N</p>	<p>Art. Kit 15977</p>  	<p>OEM 87689676</p> <p>Kit composto da: - Meccanismo 15789 - Disco PTO 15792 - Cuscinetti 15990 - 63897 - 63867</p>				
	<p>Art. 15789</p> 	<p>OEM 47134889 Meccanismo a 6 leve completo di disco centrale Piatto Ø 280 mm</p>	<p>Art. 15792</p> 	<p>OEM Disco PTO rigido in cerametallico 4 pale Ø 280 mm - 22x25 Z10</p>	<p>Art. 15990</p> 	<p>OEM Cuscinetto reggispinta cambio 90x50x22 mm</p>
	<p>Art. 15280</p> 	<p>OEM Cuscinetto reggispinta cambio 90x50x22 mm</p>	<p>Art. 62952</p> 	<p>OEM 47127081 Cuscinetto reggispinta PTO 75x115x20 mm</p>	<p>Art. 62581</p> 	<p>OEM Cuscinetto volano 17x47x14 mm</p>
			<p>Art. FAG 63897</p>		<p>Art. FAG 63867</p>	
<p>JX 70U</p>	<p>Art. 15784</p> 	<p>OEM 5167933 Meccanismo a 6 leve completo di disco centrale in ferodo senza il disco PTO Piatto Ø 310 mm</p>	<p>Art. 15785</p> 	<p>OEM 5167937 Disco PTO rigido in ferodo senza molleggio Ø 310 mm - 22x25 Z10</p>		

(segue CASE)

segue CASE

JX 100U/1070U/1080U JXU75/85/95	Art. Kit 16075  		OEM Kit composto da: - Meccanismo 15787 - Disco PTO 15788	
	Art. 15787   OEM Meccanismo Piatto Ø 310 mm	Art. 15788   OEM 5189825 Disco di avanzamento cerametallico doppio segmento a 6 pale Ø 310 mm - 40x45 mm Z16	Art. 16009   OEM 5166287 Manicotto con reggispinta	
QUANTUM 65C/N/75C/F/N/V/ 85C/F/N/V	Art. Kit 15930  		OEM 87732502 Kit composto da: - Meccanismo 15796 - Disco PTO 15792	
	Art. 15796   OEM Meccanismo a 6 leve completo di disco centrale cerametallico 5 pale Piatto Ø 280 mm 35x39,8 mm - Z.14	Art. 15792   OEM Disco PTO rigido in cerametallico 4 pale Ø 280 mm - 22x25 Z10		
MAXXUM 100-110 MXU 100-110	Art. Kit 16172  	OEM 5196060 Kit completo frizione Ø 330 con disco centrale a 5 pale Ø 330 Z.16 mozzo 40x45		
FARMALL 75A FARMALL 85C	Art. Kit 16212  		OEM 47124874 - 84342957 Kit composto da: - Meccanismo - Disco	
	Art. 62952   OEM 47127081 Cuscinetto reggispinta PTO 75x115x20 mm Art. FAG 63897	Art. 15280   OEM 87345759 Cuscinetto reggispinta cambio 90x50x22 mm Art. LUK 15990	Art. 62580   OEM 87729147 - 87302841 Cuscinetto 17x40x12 mm Art. FAG 63866	
FARMALL 55C/65C/75C	Art. Kit 16217  		OEM 84233502 Kit composto da: - Meccanismo - Disco	
	Art. 15280   OEM 87345759 Cuscinetto reggispinta cambio 90x50x22 mm Art. LUK 15990	Art. 62952   OEM 47127081 Cuscinetto reggispinta PTO 75x115x20 mm Art. FAG 63897	Art. 62580   OEM 87729147 - 87302841 Cuscinetto 17x40x12 mm Art. FAG 63866	
QUANTUM 110V QUANTUM 110N	Art. Kit 16235  	OEM Kit frizione completo composto da: - Meccanismo - Disco PTO - Cuscinetto PTO 63897 - Cuscinetto Volano 64536		
QUANTUM 100CL - 110CL 100F - 105F - 110F 100N - 110N 100V - 110V	Art. Kit 16259  	OEM 84424850 Kit frizione completo Ø 280 composto da: - Disco PTO - Cuscinetto avanzamento 15990 - Cuscinetto PTO 63897 - Cuscinetto Volano 63867		



Frizioni e loro componenti

CLUTCHES - CLUTCH DISK - BEARING - COUPLING - LEVER - SET-REVISION





























11

11

CASORZO









































MOTOFALCIATRICE (DAL 1994 IN AVANTI) MOTOZAPPA 125/125C MOTOCOLTIVATORI BRIO - GOLF	Art. 15622 	OEM Frizione Ø 103x90 mm a dischi multipli con 4 dischi 20x16x4 mm - Z.6 Albero Ø 23 mm - Conicità 1:5 Montaggio con vite M8		
MOTOCOLTIVATORE (DAL 1994 IN AVANTI) (MOT. 3LD 510)	Art. 15623 	OEM Frizione Ø 103x90 mm a dischi multipli con 5 dischi 20x16x4 mm - Z.6 Albero Ø24 - Conicità 1:5 Montaggio con boccola M16	Art. 15584 	OEM Serie dischi completa. Composta da 5 dischi di Ø 93 mm

CLAAS

AXOS 310C - 320C - 330C - 340C CELTIS 426RA/RC/RX - 436RA/RC/RX - 446RA/RC/RX - 456RA/RC/RX	Art. Kit 16049   	OEM Kit composto da: - Meccanismo 15919 - Disco PTO 15920		
	Art. 15919  	OEM 1118914 Meccanismo a 6 leve Ø 310 mm	Art. 15920  	OEM 11220851 Disco PTO Ø 310 mm 21,7x25 mm - Z.13
			Art. 62580  Art. FAG 63866	OEM Cuscinetto 17x40x12 mm
ATOS 240/340/350	Art. Kit 16041    	OEM Kit composto da: - Meccanismo 15923 - Disco centrale 15924 - Cuscinetto 15744		
	Art. 15923  	OEM Meccanismo frizione con molle a diaframma Ø 330 (13")	Art. 15924  	OEM Disco centrale a 5 pale 36,5x41 mm - Z.24
NECTIS 217VE/VL NECTIS 227F/VE/VL NEXOS 220FB	Art. Kit 15955   	OEM 6000105767 Kit Frizione bidisco con meccanismo a 6 leve e disco PTO Ø 280 mm. 34x40 mm - Z.12	Art. 63363 OEM  Art. FAG 63895 Cuscinetto PTO 100x65x18 mm	
ATOS 220/230/330	Art. Kit 16055    	OEM Kit composto da: - Meccanismo 15960 - Disco 15961 - Cuscinetto 15744		
	Art. 15960  	OEM Meccanismo frizione con molle a diaframma Ø 310 mm	Art. 15961  	OEM 0.014.9016.3 0.015.2816.3 Disco Ø 310 mm

(segue CLAAS)

segue CLAAS











































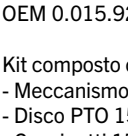







NECTIS 257VL/F NECTIS 247F NECTIS 257F	new Art. Kit 15957 	 	 	  	OEM 6000105784 Kit composto da: - Meccanismo - Disco frizione 15873 - Cuscinetti 63895 -
ELIOS 210/220/230 /240 NEXOS 210/F/VE/VL - 220F/FB/VE/VL - 230F/FB/VE/VL - 240F/ VL	Art. Kit 16254 	 	 		OEM 0011527880 Kit Frizione 6 LEVE Ø 280 completo di meccanismo e disco PTO a 4 pale Z.13
	Art. 62597 OEM  Art. FAG 63883 Cuscinetto avanzamento 45x75x16 mm		Art. 63363 OEM  Art. FAG 63895 Cuscinetto PTO 100x65x18 mm		Art. 62580 OEM  Art. FAG 63866 Cuscinetto volano 17x40x12 mm
ELIOS 210/220/230 NECTIS 237F/VE/VL NECTIS 247F NECTIS 257F/VL NECTIS 267F/VL NEXOS 210F/VE/VL NEXOS 220F/VE/VL NEXOS 230F/FB/VE/VL	Art. Kit 16105 	 	 		OEM 6000105777 - 0011527880 Kit composto da: - Meccanismo 15958 - Disco PTO 15873
	Art. 15958 OEM   Frizione bidisco a 6 leve Ø 280 mm con disco a 6 pale 34x40 mm - Z.12		Art. 15873 OEM 6000105778   Disco frizione rigido sinterizzato a 4 pale mozzo 22x19 mm - Z.13		Art. 63363 OEM  Art. FAG 63895 Cuscinetto PTO 100x65x18 mm
					Art. 16253 OEM 148041 new   - ER148041 - 6000105792 - 3695991M1 Cuscinetto reggispinta 75x45x16 mm
	new Art. Kit 16258 	 	 		OEM 0011574280 Kit composto da meccanismo Ø 310 e disco PTO a 4 pale Ø 280 Z.13 mozzo 22x19
AXOS 310CL/CX AXOS 320CL/CX AXOS 330CL/CX AXOS 340CL/CX CELTIS 426RA/RC/RX CELTIS 436RA/RC/RX CELTIS 446RA/RC/RX CELTIS 456RA/RC/RX	Art. Kit 16106 	 	 	  	OEM 11380601 Kit Frizione monodisco completo di meccanismo, disco interno Ø 310 Z.13, cuscinetto 65x100x18, cuscinetto 17x40x12

Frizioni e loro componenti

CLUTCHES - CLUTCH DISK - BEARING - COUPLING - LEVER - SET-REVISION





























11

DEUTZ

<p>DX 80 - DX 85/A - DX 86 - DX 90/A - DX 92 AGROPRIMA 4.31/ 4.51/4.56/6.06/ 6.16 AGROXTRA 4.47/ 4.57/6.07/6.17 DX 4.10/4.30/4.31/ 4.50/4.51/4.57H/ 4.70/5.30/5.50/5.70/ 6.05</p>	<p>Art. Kit 16050</p>      	<p>OEM</p> <p>Kit composto da: - Meccanismo 15568 - Disco PTO 15570 - Cuscinetti 16051 - 16052 - 63870</p>	
	<p>Art. 15568 Meccanismo a 6 leve Piatto Ø 310 mm</p>  	<p>Art. 15569 OEM 438.6687 Disco centrale metaceramico molleggiato a 8 pale Ø 310 mm sint - Z.21</p>  	<p>Art. 15570 OEM 437.8779 Disco preza di forza rigido in ferodo Ø 280 mm - Z.16</p>  
	<p>Art. 16051 OEM 4383378 Cuscinetto reggi spinta 97x23x65 mm</p>  	<p>Art. 16052 OEM 4383379 Cuscinetto reggi spinta 140x25x106 mm</p>  	<p>Art. 62584 OEM Cuscinetto 20x52x15 mm</p>   <p>Art. FAG 63870</p>
<p>AGROPRIMA 4.31/ 4.51/4.56/6.06/ 6.16 AGROXTRA 4.47/ 4.57/6.07/6.17</p> <p>DX110 - DX120 DX 4.30/4.31/ 4.50/4.51/4.57H/ 4.70/6.10/6.30</p>	<p>Art. 15568 Meccanismo a 6 leve Piatto Ø 310 mm</p>  	<p>Art. 16257 OEM 02940358 - 04378783 - 04371480 Disco PTO rigido in ferodo, per meccanismo 15568 310 mm 31x35 - Z.15</p>  	<p>Art. 15755 OEM Cuscinetto reggispinna 96,5x65x23,5 mm</p>  
	<p>Art. 15756 OEM 11310940 Cuscinetto reggispinna PTO 106x139,5x25 mm</p>  	<p>Art. 62584 OEM Cuscinetto 20x52x15 mm</p>   <p>Art. FAG 63870</p>	
<p>AGROCOMPACT 80/FV/90F/100/F70/ F75 AGROLUX 60/70/F60/ F70/F80/F100 AGROPLUS 67/70/77/ 80/87/F70/F75/F90/ F100 AGROCLIMBER F90C/ F90M/F90N</p>	<p>Art. 15746 OEM 0.015.9285.3 0.008.4254.3/10 Meccanismo con molla a diaframma piatto Ø 310 mm</p>  	<p>Art. 15963 OEM 44623.303 0.455.2330.3/10 0.015.9288.3 Disco centrale in ferodo con molle parastrappi 310x191x3,5 mm 40x36,5 mm - Z.24</p>  	<p>Art. 15441 OEM 44623.303 0.455.2330.3/10 0.015.9288.3 Disco centrale in ferodo con molle parastrappi 310x191x3,5 mm 40x36,5 mm - Z.24</p>  
	<p>Art. 15962 OEM 0.015.9289.3 0.014.1111.3 Disco centrale metaceramico 6 pale con parastrappi Ø310 sinterizzato 41x36 mm - Z.24</p>  	<p>Art. 15748 OEM 0.015.9289.3 0.014.1111.3 Disco centrale metaceramico 6 pale con parastrappi Ø310 sinterizzato 40x36,5 mm - Z.24</p>  	<p>Art. 15744 OEM 2.2999.475.0 Cuscinetto reggispinna cambio 90x55x22 mm</p>  
<p>AGROCOMPACT 60F/V 70F/V AGROLUX 60/F60 AGROPLUS 60/67</p>	<p>Art. Kit 16038</p>    		<p>OEM 0.015.9287.3</p> <p>Kit composto da: - Meccanismo 15439 - Disco PTO 15979 - Cuscinetti 15744</p>
	<p>Art. 15439 OEM 0.015.9287.3 255.2320.3/10 0.009.6914.3/20 Meccanismo con molle a diaframma Piatto Ø 280 mm</p>  	<p>Art. 15979 OEM 0.015.9286.3 Disco frizione centrale in ferodo con molle parastrappi 280x172x3,5 mm 40x36,5EV - Z.24</p>  	<p>Art. 15440 OEM. 0.015.9286.3 0.009.6913.3/10 255.2330.3/20 270.2330.3/10 Disco frizione centrale in ferodo con molle parastrappi 280x172x3,5 40x36,5EV - Z.24</p>  
			<p>Art. 15744 Cod orig. 2.2999.475.0 Cuscinetto reggispinna 90x55x22 mm</p>  

(segue DEUTZ)

segue DEUTZ

AGROCOMPACT 80F/V/90F/F60 AGROLUX 70/F70 AUTOPLUS 70-80	Art. 15420  LUK	OEM 0.014.9424.3 0.008.4293.3 0.008.4254.3/10 Meccanismo con molle a diaframma Piatto Ø 310 mm	Art. 15962  LUK	OEM 0.015.9289.3 0.014.1111.3 Disco centrale metaceramico 6 pale con parastrappi Ø310 sinterizzato 41x36 mm - Z.24	Art. 15748 	OEM 0.015.9289.3 0.014.1111.3 Disco centrale metaceramico 6 pale con parastrappi Ø310 sinterizzato 40x36,5 mm - Z.24
	Art. 15982  LUK	OEM 0.015.9289.3 0.014.1111.3 Disco centrale metaceramico 6 pale Ø310 sinterizzato 40x36,5 mm - Z.24	Art. 15895  LUK	OEM 0.015.9289.3 0.014.1111.3 Disco centrale metaceramico 6 pale con parastrappi Ø310 sinterizzato 41x36,5 mm - Z.24	Art. 15744 	OEM 2.2999.475.0 Cuscinetto reggispinta cambio 90x55x22 mm
AGROCOMPACT 3.30F/V-3.50-3.70-3.90 AGROXTRA 3.57-4.07 D4807/C-D5006/U- D5207/C-D5206/U- D5506/U-D6007/C- D6207/C-D6507- D6907/C- DX3.65SC/VC ITRAC 2002/2003/2004	Art. 15951  LUK	OEM 0.294.07.38 - 4401103 Meccanismo doppio a 6 leve Ø 280 mm con disco centrale in organico. 36x40 mm - Z.20	Art. 15952  LUK	OEM 02.940.363 - 2313468 Disco PTO Ø 250 mm 28x32 mm - Z.17	Art. 62951  LUK	OEM Cuscinetto reggispinta PTO 70x110x20 mm
	Art. 62584  LUK	OEM Cuscinetto 20x52x15 mm	Art. 16053  LUK	OEM Cuscinetto 92x55x18,5 mm	Art. FAG 63896	
AGROCLIMBER 105/ 410/410six AGROFARM 100/ 100C/85C/90C/95C/ 100Ecoline/420/420T/ 430 AGROLUX 100/87/ 87LP/90/95/97/97LP/ F50 AGROPLUS 95NEW AGROTRAC 100/110 5100C/G - 5105.4G - 5115.4G - 5110C	Art. Kit 16041  LUK	 LUK	 LUK	 LUK	OEM Kit composto da: - Meccanismo 15923 - Disco PTO 15924 - Cuscinetti 15744	
	Art. 15923  LUK	OEM Meccanismo frizione con molle a diaframma Ø 330 (13")	Art. 15924  LUK	OEM Disco centrale a 5 pale 36,5x41 mm - Z.24	Art. 15744  LUK	OEM Cuscinetto reggispinta 90x55x22 mm
AGROCLIMBER F110MN/F90CMN/ 400F/410/F/410SIX AGROFARM 410/85/ 85 Ecoline/410T Eco./ 420T Eco./410T/ 410TB/420TB AGROLUX 80/85 AGROPLUS 100S/70S/75S/90S/ F100/F70/F75/F90/ 315/ 320/N/330V/ 410/F/V/ 420FV/ 430V/ 5090C/D - 5090.4D - 5080G/D - 5090G - 5090.4G	Art. Kit 16055  LUK	 LUK	 LUK	 LUK	OEM Kit composto da: - Meccanismo 15960 - Disco PTO 15961 - Cuscinetti 15744	
	Art. 15960  LUK	OEM Meccanismo frizione con molle a diaframma Ø 310 mm	Art. 15961  LUK	OEM 0.014.9016.3 0.015.2816.3 Disco Ø 310 mm	Art. 15744  LUK	OEM Cuscinetto reggispinta 90x55x22 mm
AGROKID 30/35/40/ 45/50/55/210/220/ 230	Art. Kit 15987  LUK	 LUK	 LUK	OEM 0.012.5851.4/20 Kit frizione doppia a 6 leve composto da: - disco interno a molle Ø 225 mm Z. 19 - disco PTO rigido Ø 225 mm Z. 12		

(segue DEUTZ)

Frizioni e loro componenti

CLUTCHES - CLUTCH DISK - BEARING - COUPLING - LEVER - SET-REVISION

11



















11

segue DEUTZ

<p>AGROLUX 4.75/E/ 410 AGROPLUS F70/410/</p>	<p>Art. Kit 16107 </p>		<p>OEM 0.017.7889.4 KIT meccanismo con disco Ø 330 mm</p>
<p>AGROLUX F57</p>	<p>Art. Kit 16044 </p>		<p>OEM Kit Frizione con meccanismo a 6 leve disco PTO, disco centrale e cuscinetti Piatto Ø 250 mm.</p>
	<p>Art. 15395 OEM  Meccanismo a 6 leve completo di disco centrale in ferodo senza il disco PTO Piatto Ø 250 mm (11")</p>	<p>Art. 15804 OEM  Disco PTO rigido in ferodo 225x145x3,5 mm 25x22EV - Z.14</p>	
<p>AGROSUN 100/120/140 AGROTAC 110</p>	<p>Art. Kit 15394 </p>	 <p>OEM KIT meccanismo presa di movimento con disco</p>	<p>Art. 15293 OEM  Disco centrale metalceramico a 7 pale Rigido Ø 350 mm sinterizzato 50x45EV - Z.24</p>
<p>AGROCLIMBER V70C/ V70N/V80L/ V80M AGROPLUS 420F Ecoline</p>	<p>Art. 15722 OEM  Meccanismo a 6 leve. Piatto Ø 280 mm (11")</p>	<p>Art. 15397 OEM  Disco centrale rigido in ferodo 280x165x3,5 mm 40x36EV - Z.20</p>	<p>Art. 15121 OEM  Disco PTO rigido, in ferodo 280x165x3,5 mm 25x22EV - Z.14</p>
<p>AGROLUX 57/F57/F67 AGROPLUS Keyline 405F AGROPLUS Ecoline 310/F/315/F/320/F/405F/410F</p>	<p>Art. 15916 OEM  Meccanismo a 6 leve completo di disco Ø 280 mm</p>	<p>Art. 15917 OEM  Disco Ø 280 mm 22x25 mm - 14 cave</p>	
<p>AGROLUX 4./410/80 AGROPLUS Keyline Serie 4E Serie 4EF Serie 5D / Keyline Serie 5DF Keyline Serie 5DK</p>	<p>Art. Kit 16276 </p>		<p>OEM 0.017.7890.4 Kit Frizione con meccanismo a 6 leve disco e cuscinetti. Piatto Ø 310 mm.</p>
	<p>Art. 15990 OEM  Cuscinetto reggispinta cambio 90x50x22 mm</p>	<p>Art. 63363 OEM  Cuscinetto PTO 100x65x18 mm Art. FAG 63895</p>	<p>Art. 62549 OEM  Cuscinetto volano 20x47x14 mm Art. FAG 63836</p>

(segue DEUTZ)

segue DEUTZ

AGROLUX 80/90	Art. 15985 OEM Meccanismo frizione con molle a diaframma Ø 350 mm 	Art. 15984 OEM Disco PTO 6 pale Ø 330 mm 36x40 mm - Z24 	
AGROLUX 90 AGROPLUS 75/85/95/100	Art. 15954 OEM 0.010.6912.3/10 0.015.6386.3 Meccanismo con molle a diaframma Piatto Ø 350 mm 	Art. 15953 OEM 0.007.7929.3/10 0.015.6328.3 Disco Ø 350 mm 36,5x41 mm - Z.24 	Art. 15983 OEM 0.007.7930.3/10 Disco Ø 350 mm 41x45 mm - Z.21 
		Art. 16010 OEM 0.015.6381.3 Disco Ø 330 mm 36,5x41 mm - Z.24 	Art. 15744 OEM 2.2999.475.0 Cuscinetto reggispinta 90x55x22 mm 
AGROLUX 55/60/65/70/75/310/320 AGROMAXX 55/60/4055/4060 AGROPLUS F Keyline Serie 3E/4E/4EF/5D	Art. Kit 16218      		OEM 9.J1424.00.9 - 0.015.4708.3/10 Kit Frizione con meccanismo a 6 leve disco e cuscinetti. Piatto Ø 280 mm.
AGROTRAC 115 - 130 - 150 - 170 - 610 - 620	Art. Kit 16233    		OEM 9.P023.00.9 Kit Frizione mono disco con cuscinetto reggispinta. Ø 350 mm.
	Art. 16234 OEM 0.015.7949.3 0.015.7949.3/10 Disco frizione a 7 pale Ø 350 mm - Z.24 	Art. 15883 OEM 2.2999.510.0 2.2999.207.0 2.2999.443.0 112x65x42 mm Cuscinetto reggispinta 	









Frizioni e loro componenti

CLUTCHES - CLUTCH DISK - BEARING - COUPLING - LEVER - SET-REVISION







11

11

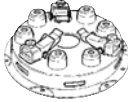

DIESSE

MT2 ERCOLE ORSETTO ERCOLINO	Art. 15339 	Frizione bidisco con molle a diaframma completa di disco centrale Piatto Ø 110 mm	Art. 15019 	Disco frizione rigido in ferodo 110x58x3 mm 15x12EV - Z.8	Art. 15042 	OEM Manicotto con cuscinetto reggispinta
MT2 ORSETTO	Art. 15321 	OEM Frizione monodisco con molle a diaframma Piatto Ø 95 mm	Art. 15189 	OEM Disco frizione rigido 94x61x1,5 mm 15x12EV - Z.8	Art. 15042 	OEM Manicotto con cuscinetto reggispinta
MOTOZAPPA 2 ORSETTO	Art. 15834 	OEM Frizione Ø 103x67,5 mm a dischi multipli con 4 dischi 12x15EV - Z.8 Albero Ø 23 mm	Art. 15630 	OEM Disco frizione sinterizzato Ø 93 mm		



















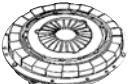



DISALCAR

TRANSPORTER 20HP	Art. 15296 	OEM Meccanismo monodisco a molle elicoidali Piatto Ø 184 mm	Art. 15031 	OEM F0819134020 Disco frizione rigido 180x127x3,8 mm 23x20EV Z.20		
TRANSPORTER 30HP	Art. 15716 	OEM Frizione monodisco con molle elicoidali Piatto Ø 215 mm	Art. 15099 	OEM Disco frizione rigido 215x152x3,8 mm 23x20EV - Z.20		
TRANSPORTER 30HP	Art. 15149 	OEM Frizione monodisco con molle elicoidali Piatto Ø 215 mm	Art. 15099 	OEM Disco frizione rigido 215x152x3,8 mm 23x20EV - Z.20		

ERREPI

TRANSPORTER MOTOAGRICOLE	Art. 15298 	OEM Frizione monodisco con molle a diaframma Piatto Ø 160 mm	Art. 15029 	OEM Disco frizione rigido 160x110x3,8 mm 23x20EV Z.20	Art. 15043 	OEM Manicotto con cuscinetto reggispinta
-----------------------------	--	--	--	---	--	---

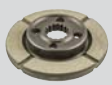
EUROGARDEN

MOTOZAPPA E MOTOCOLTIVATORI JOLLY (DAL 1992 IN AVANTI)		Art. 15588 OEM Frizione monodisco con molle a diaframma Piatto Ø 90 mm Albero Ø 22,5 mm Conicità 1:5 15x12EV - Z.8		Art. 15525 OEM Disco frizione rigido in ferodo - 86x50x3,5 mm 15x12EV - Z.8		Art. 15189 OEM Disco frizione rigido in ferodo - 94x60x3 mm 15x12EV - Z.8
				Art. 15763 OEM Disco frizione rigido in ferodo 89x55x11 mm 15x12EV - Z.8	Art. 15042 OEM Manicotto con cuscinetto reggispinta	
MOTOZAPPA E MOTOCOLTIVATORI TUCANO		Art. 15624 OEM Friz. Ø103x70,5 mm a dischi multipli con 4 dischi Albero Ø 23 mm Conicità 1:5 15x12 - Z.8		Art. 15625 OEM Serie dischi completa composta da 4 dischi di Ø 93 mm		Art. 15629 OEM Manicotto con cuscinetto reggispinta
MOTOZAPPA LASER 2ª SERIE (DAL 1992 IN AVANTI)		Art. 15613 OEM Frizione conica Ø 103x105,5 mm Albero Ø 22,5 mm Conicità 1:5 17x14EV - Z.9				
MOTOCOLTIVATORI TITANO (FINO AL 08/1993)		Art. 15002 OEM Frizione monodisco con molle a diaframma Piatto Ø 110 mm		Art. 15022 OEM Disco frizione rigido in sinterizzato 110x75x3 mm 15x12EV - Z.8		Art. 15042 OEM Manicotto con cuscinetto reggispinta
MOTOCOLTIVATORI TITANO (DAL 09/1993 IN AVANTI)		Art. 15615 OEM Frizione monodisco con molle a diaframma Piatto Ø 120 mm		Art. 15616 OEM Disco frizione rigido in sinterizzato 120x90x3,5 mm 15x12EV Z.8		Art. 15042 OEM Manicotto con cuscinetto reggispinta
MOTOCOLTIVATORI TITANO (FINO AL 04/1994)		Art. 15339 OEM Frizione bidisco con molle a diaframma Piatto Ø 110 mm		Art. 15022 OEM Disco frizione rigido in sinterizzato 110x75x3 mm 15x12EV Z.8		Art. 15042 OEM Manicotto con cuscinetto reggispinta
MOTOZAPPA LASER 2ª SERIE (DAL 1993 IN AVANTI)		Art. 15614 OEM Frizione conica Ø 104 mm Albero Ø 19,5 mm Conicità 1:5 17x14EV - Z.9				
MOTOCOLTIVATORI TITANO - CAIMANO (DAL 05/1994 IN AVANTI)		Art. 15617 OEM Frizione bidisco completa di disco centrale Piatto Ø 120 mm		Art. 15616 OEM Disco frizione rigido in sinterizzato 120x90x3,5 mm 15x12EV Z.8		Art. 15042 OEM Manicotto con cuscinetto reggispinta
MOTOCOLTIVATORI REKORD		Art. 15608 OEM Disco frizione rigido in ferodo 122x80x11,5 mm 28x25EV - Z.15				
MOTOCOLTIVATORE EURO 90		Art. 15717 OEM Frizione conica Ø 103x79 Albero Ø 23 mm Conicità 1:5 15x12 mm - Z.8				
MOTOCOLTIVATORE EURO 90 (attacco Ø19,05)		Art. 15718 OEM Frizione conica Ø 103x76,5 Albero Ø 19,05 Conicità 1:5 15x12 mm - Z.8				







Frizioni e loro componenti

CLUTCHES - CLUTCH DISK - BEARING - COUPLING - LEVER - SET-REVISION







































11

11





















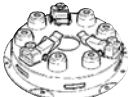

EUROSYSTEMS

MOTOZAPPA (DIESEL)	Art. 15719 	Frizione conica Ø 103x100 Albero Ø 23 mm Conicità 1:5 15x12 mm - Z.8		
MOTOZAPPA (BENZINA)	Art. 15001 	Frizione conica Ø 103x100 mm Albero Ø 22,5 mm Conicità 1:5 15x12EV - Z.8		
MOTOZAPPA MOTOCOLTIVATORI	Art. 15589 	Frizione Ø 103x99 mm a dischi multipli con 4 dischi 15x12EV - Z.8 Albero Ø 23 mm Conicità 1.5		
TRATTORINO FLORIDA	Art. 15013 	OEM Frizione monodisco con molle a diaframma Piatto Ø 160 mm	Art. 15030 OEM  Disco frizione rigido 160x110x3,8 mm 17x14EV Z.9	Art. 15043 OEM  Manicotto con cuscinetto reggispinta

FENDT

FARMER 206F/FA/S/V/VA - 207F/FA/S/V/VA - 208F/FA/S/V/VA - 209F/FA/S/V/VA -	Art. Kit 16111 	     	OEM E210.10.3100.040 Kit Frizione bidisco Ø 295/330 completo di: disco PTO rigido Ø 320 mm Z.10, cuscinetto 45x75x16 cuscinetto 64,5x100x30 cuscinetto 106x140x21 cuscinetto 20x42x12
FARMER 240S - 250S/V - 260P/S/V	Art. Kit 16112 	     	OEM E205.100.100.010 Kit Frizione bidisco Ø 265/250 completo di: disco PTO rigido Ø 250 mm Z.10, cuscinetto 40x68x15 cuscinetto 65x97x19 cuscinetto 106x140x21 cuscinetto 20x52x15
FARMER 260P/S - 270P/V - 275S/V - 280P (fino a telaio 248/1413)	Art. Kit 16113 	     	OEM Kit Frizione bidisco Ø 280/295 completo di: disco PTO rigido Ø 295 mm Z.10, cuscinetto 40x68x15 cuscinetto 65x97x19 cuscinetto 106x140x21 cuscinetto 20x52x15
FARMER 260V - 270P/V - 275S/V - 280P/S/V (da telaio 248/1414)	Art. Kit 16114 	     	OEM Kit Frizione bidisco Ø 280/295 completo di: disco PTO rigido Ø 295 mm Z.10, cuscinetto 40x68x15 cuscinetto 65x97x19 cuscinetto 106x140x21 cuscinetto 20x52x15
FARMER 303 - 304LS/S - 305LS/S - 306LS/S - 307Ci/LS/LSA - 308Ci/LS/LSA/S - 309Ci/LS/LSA/S - 310LS/LSA - 311LS/LSA - 312LS/LSA	Art. Kit 16115 	   	OEM Kit Frizione monodisco Ø 330 completo di: disco PTO rigido Ø 330 mm Z.10, cuscinetto 64,5x100x30 cuscinetto 20x42x12
FAVORIT 611LSA - 612LSA - 614LSA - 615LSA	Art. Kit 16116 	   	OEM Kit Frizione monodisco Ø 360 completo di: disco PTO a 6 pale Ø 360 mm cuscinetto 60x104x53 cuscinetto 40x68x15

FERRARI

MOTOCOLTIVATORI 71 (1ª SERIE)	Art. 15002  OEM 81.9220.000 Frizione monodisco con molla a diaframma Piatto Ø 110 mm	Art. 15019  OEM 81.9221.00 Disco frizione rigido 110x58x1,5 mm 15x12EV - Z.8	Art. 15057  OEM Leva a forcella
	Art. 15050  OEM Cuscinetto reggispinta	Art. 15042  OEM Manicotto con cuscinetto reggispinta	
MOTOCOLTIVATORI 71 (2ª SERIE)	Art. 15001  Frizione conica Ø 103x100 mm Albero Ø 22,5 mm Conicità 1:5 15x12EV - Z.8		
MOTOCOLTIVATORI MC 64	Art. 15003  OEM 81.9302.00 Frizione monodisco a molle elicoidali Piatto Ø 140 mm	Art. 15021  OEM Disco frizione rigido 140x96x3,8 mm 17x14x4 Z.6	
MOTOCOLTIVATORI SERIE 90	Art. 15527  Frizione Ø 103x99 mm A dischi multipli con 5 dischi 15x12EV - Z.8 Albero Ø 23 mm Conicità 1:5	Art. 15625  OEM Serie dischi completa composta da 4 dischi di Ø 93 mm	
MOTOCOLTIVATORI 72 (1ª SERIE) MOTOCOLTIVATORI MC68	Art. 15003  OEM 81.9302.00 Frizione monodisco a molle elicoidali Piatto Ø 140 mm	Art. 15020  OEM 81.9033.00 Disco frizione rigido 140x96x3,8 mm 17x15EV - Z.20	
	Art. 15044  OEM 81.9056.00 Manicotto con anello in grafite		
MOTOCOLTIVATORI 72 (2ª SERIE)	Art. 15004  OEM 81.9306.10 Frizione monodisco a molle elicoidali Piatto Ø 160 mm	Art. 15028  OEM 81.9304.20 Disco frizione rigido 160x112x3 mm 17x15EV - Z.20	Art. 15067  OEM 81.9304.30 Leva a forcella
	Art. 15051  OEM 81.9305.30 Cuscinetto reggispinta	Art. 15048  OEM 81.9305.10 Manicotto	
TRATTORINI 72T	Art. 15004  OEM 81.9308.010 Frizione monodisco a molle elicoidali Piatto Ø 160 mm	Art. 15028  OEM 81.9304.20 Disco frizione rigido 160x112x3 mm 17x15EV - Z.20	Art. 15067  OEM 81.9304.30 Leva a forcella
	Art. 15051  OEM 81.9305.20 Cuscinetto reggispinta	Art. 15048  OEM 81.9305.10 Manicotto	
(segue FERRARI)			























Frizioni e loro componenti

CLUTCHES - CLUTCH DISK - BEARING - COUPLING - LEVER - SET-REVISION



















11

11

segue FERRARI

MOTOCOLTIVATORI 74 - TRATTORINI 74-75 (1ª SERIE)	Art. 15012  OEM 81.9134.00 Frizione monodisco con molle a diaframma Piatto Ø 180 mm Ø foro diaframma 30mm H=41 mm	Art. 15031  OEM F0819134020 Disco frizione rigido 180x127x3,8 mm 23x20EV Z.20	
	Art. 15043  OEM 81.9134.30 Manicotto con cuscinetto reggispinta		
TRATTORINO 76 MA 45/R	Art. 15014  OEM 81.9134.60 Frizione monodisco con molle a diaframma Piatto Ø 180 mm Ø foro diaframma 30mm H=45,5 mm	Art. 15031  OEM F0819134020 Disco frizione rigido 180x127x3,8 mm 23x20EV - Z.20	Art. 15043  OEM 81.9134.30 Manicotto con cuscinetto reggispinta
TRATTORINO 75 (2ª SERIE) - 94 - 95	Art. 15015  OEM F0819134060 Frizione monodisco con molle a diaframma Piatto Ø 180 mm Ø foro diaframma 36mm	Art. 15031  OEM F0819134020 Disco frizione rigido 180x127x3,8 mm 23x20EV - Z.20	Art. 16209  OEM Cuscinetto appoggio bombato 27x70x45
MOTOCOLTIVATORI MC58 - MC60/2 - TRATTORINI MT65 (1ª SERIE)	Art. 15006  OEM Frizione monodisco con molle elicoidali Piatto Ø 187 mm	Art. 15036  OEM 101342 Disco frizione rigido 184x127x3,8 mm 29x23x4,5 - Z.10	
	Art. 15055  OEM 81.2878.00 Cuscinetto reggispinta	Art. 15049  OEM Manicotto con molla	
TRATTORINI MT65 (2ª SERIE)	Art. 15149  OEM Frizione monodisco con molle elicoidali Piatto Ø 215 mm	Art. 15202  OEM 715208 Disco frizione rigido 216x152x3,8 mm 29x23x4,5 - Z.10	
	Art. 15055  OEM 81.2878.00 Cuscinetto reggispinta	Art. 15049  OEM Manicotto con molla	
TRATTORI 95 - 95 RS - TRANSPORTER 933 (doppia frizione)	Art. 15720  OEM 0819180090 Meccanismo a 3 leve completo di disco centrale in ferodo. Piatto Ø 180 mm	Art. 15263  OEM 819160020 Disco frizione rigido PTO 180x126x3,2 mm 17x15EV - Z.20	Art. 15721  OEM Disco frizione centrale 180x126x3,2 mm 35x31EV Z.18
			Art. 15272  OEM 81.9160.030 Cuscinetto reggispinta 82x50x28
VIPER 30 AR/RS VIPER 40 AR/RS	Art. Kit 16082  LUK Kit meccanismo più disco frizione. Piatto Ø 180 mm	OEM	

FIAT RUOTE - NEW HOLLAND

18 LA PICCOLA - 200 - 211R - 213 R - 241 R - 251 D - 215 R (FINO A TELAIO 313566) - 220 C	Art. 15296  OEM 4023341 Frizione monodisco con molle elicoidali Piatto Ø 187 mm	Art. 15101  OEM 594806 Disco rigido frizione 184x127x3,3 mm 22x18x3,5 Z.10	
	Art. 15052  OEM 5119290 Cuscinetto reggispinta 68x36x19 mm	Art. 15047  OEM 5119288 Manicotto	
25R - 25RS - 25CI - CP - CSI (TIPO A PEDALE) - 215R (DAL TELAIO 313667) 311-312-315N-331R	Art. 15149  OEM 558106 - 595731- 5134614 Frizione monodisco con molle elicoidali Piatto Ø 215 mm	Art. 15027  OEM 594614-595725 Disco frizione rigido in ferodo 216x152x3,5 mm 22x18x3,5 mm Z.10	Art. 15052  OEM Cuscinetto reggispinta 68x36x19 mm
			Art. 15047  OEM 5119288 Manicotto
250 - 255 C - 300	Art. 15149  OEM 558106 - 595731- 5134614 Frizione monodisco con molle elicoidali Piatto Ø 215 mm	Art. 15148  OEM 4968661 - 5134615 - 5160429 Disco frizione rigido in ferodo 216x152x3,3 25x22EV - Z.10	
	Art. 15052  OEM 5119290 Cuscinetto reggispinta 68x36x19 mm	Art. 15047  OEM 5119288 Manicotto	
311R - 312 - 315 - 331R - 411R - 415 - 431R FRIZIONE DOPPIA	Art. 15104  OEM 594915-4968740 Disco centrale rigido in ferodo 230x160x3,3 mm 40x35EV - Z.14	Art. 15105  OEM 594916-4968742 Disco PTO rigido in ferodo 230x160x3,3 mm 22x18x3,5 - Z.10	Art. 15861  OEM 894827 Cuscinetto reggispinta
350 - 400 - 411 - 415 - 415 DT - 431 - FRIZIONE MONODISCO	Art. 15345  OEM 4960118-546051 Frizione monodisco con molle elicoidali Piatto Ø 250 mm	Art. 15234  OEM 553914 Disco frizione rigido in ferodo 250x155x4,3 mm 35x29x5,5 mm Z.10	Art. 15365  OEM Cuscinetto reggispinta
			Art. 15364  OEM Manicotto
(segue FIAT RUOTE - NEW HOLLAND)			



















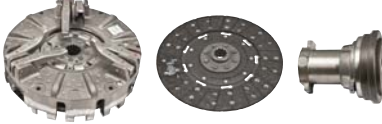



Frizioni e loro componenti

CLUTCHES - CLUTCH DISK - BEARING - COUPLING - LEVER - SET-REVISION

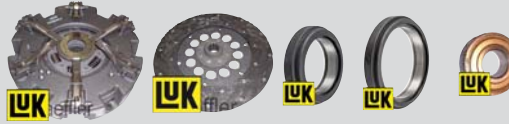
11



































11

segue FIAT RUOTE - NEW HOLLAND

350 - 400 - 420 - 450 - 450R - 470 - 480 - 480/8 - 500 - 540	Art. 16214  OEM 5161246 Meccanismo frizione a 3 leve con bordino 250 mm 	Art. 16215  OEM 4987712-4974472 Meccanismo frizione a 3 leve senza bordino 250 mm 	Art. 15107 OEM 4968736-4994353 Disco PTO rigido in ferodo 254x164x3,5 mm 25x22EV - Z.10 
	Art. 15179 OEM 4970720-4968733 Disco centrale rigido in ferodo 254x164x3,5 mm 40x35EV - Z.14 	Art. 15106 OEM 5109828-5161247 Disco centrale rigido in ferodo 254x164x3,8 mm 40x35EV - Z.14 	Art. 15862 OEM 5103178 Cuscinetto reggispinta 
850 - 850 DT - 1000 SUPER - 1000 DT SUPER	Art. Kit 15662   OEM 1930990 - Meccanismo a 6 leve completo di disco centrale metalceramico molloggiato fornito con il disco PTO e cuscinetto reggispinta - Piatto Ø 310 mm (12")		
	Art. Kit 16045   OEM 1930990 - Meccanismo a 6 leve completo di disco centrale metalceramico molloggiato fornito con il disco PTO e cuscinetto reggispinta - Piatto Ø 310 mm (12")		
	Art. 15277 OEM 5107374 5160414 - 44016542 Disco PTO rigido in ferodo 310x175x3,5 mm 32x28EV - Z.11 	Art. 15416 OEM 44015757 Disco centrale metalceramico con molle Ø 310 mm sinterizzato 45x40EV - Z.16 	Art. 15864 OEM 44011614 Cuscinetto reggispinta 55x92x22 mm (tolleranza 8mm) 
			Art. 16186  OEM 15971831 Vite 10x1,25x100 - R10.9 
1000 NORMALE - 1000 DT NORMALE	Art. Kit 16072   OEM 5164573 - 88203026 Kit composto da: - Meccanismo - Disco PTO 15563 - Cuscinetti 15755 - 15756 - 63869		
	Art. 15562 OEM 4998654 5164568 Disco centrale metalceramico con molle a 6 pale Ø 330 mm sinterizzato 45x40EV - Z.16 	Art. 15563 OEM 5164569 Disco PTO rigido in ferodo 330x200x3,5 mm - Z.11 	Art. 15755 OEM 5120853 Cuscinetto reggispinta cambio 96,5x65x23,5 mm 
		Art. 15756 OEM 44016827 Cuscinetto reggispinta PTO 106x139,5x25 mm 	Art. 62583 OEM 28042740 Cuscinetto volano 20x47x14 mm  Art. FAG 63869

(segue FIAT RUOTE -
NEW HOLLAND)

segue FIAT RUOTE - NEW HOLLAND

650 - 650 DT - 750 - 750DT	Art. 15383 OEM 44015415 - 5160409 Disco centrale rigido in ferodo 310x175x3,5 mm 45x40EV - Z.16		Art. 15277 OEM 5107374 5160414 - 44016542 Disco PTO rigido in ferodo 310x175x3,5 mm 32x28EV - Z.11		Art. 15969 OEM 5102263 - 5160410 Disco PTO rigido in ferodo 280x165x3,5 mm 28x24EV - Z.10		
			Art. 15802 OEM 9004189 Disco frizione centrale rigido 310x190x3,5 35x30EV H35-Z.12		Art. 15799 OEM 9023573 Cuscinetto reggispira solo per 750 - 750 DT 65x102x26 mm		
880 - 880DT Tipo VALEO	Art. 15866 OEM 5177197 Cuscinetto reggispira completo doppio		Art. 15556 OEM 5104790 - 9929202 Disco centrale metalceramico rigido a 6 pale Ø 280 mm sinterizzato 45x40EV - Z.16		Art. 15372 OEM 5160420 - 9929199 Disco PTO in ferodo 280x165x3,8 mm 28x24EV - Z.10		
	Art. 15863 OEM 599930 Cuscinetto reggispira						
880.4 - 880.4 DT	Art. Kit 15558			OEM 5122376 Meccanismo a 6 leve completo di disco centrale sinterizzato, fornito senza il disco PTO Piatto Ø 310 mm (12")			
				Art. 15559 OEM 5122377 Disco centrale metalceramico rigido a 6 pale Ø 310 mm sinterizzato 45x40EV - Z.16		Art. 15581 OEM 5104880 - 5160417 Disco PTO rigido in ferodo 310x190x4 mm 28x24EV - Z.10	
850 - 880 - 880.4	Art. Kit 16077						OEM 5160430 - 5114526 - 88203010 Kit composto da: - Meccanismo 15555 - Disco PTO 15969 - Cuscinetti 15990 - 63896 - 63867
							
	Art. 15555 OEM 5114526-5160430 Meccanismo a 6 leve completo di disco centrale sinterizzato. Fornito senza il disco PTO Piatto Ø 280 mm (11")		Art. 15969 OEM 5102263 - 5160410 Disco PTO rigido in ferodo 280x165x3,5 mm 28x24EV - Z.10		Art. 15557 OEM 5102263 - 5160410 Disco PTO rigido in ferodo 280x165x3,5 mm 28x24EV - Z.10		
	Art. 15556 OEM 5102262 Disco centrale metalceramico rigido a 6 pale Ø 280 mm sinterizzato 45x40EV - Z.16		Art. 15990 OEM 5119290 5119875 - 5122028 - 87345759 Cuscinetto reggispira cambio 90x50x22 mm		Art. 15280 OEM 5119290 - 5119875 - 5122028 - 87345759 Cuscinetto reggispira cambio 90x50x22 mm		
		Art. 62951 OEM 24905360 - 84455696 Cuscinetto reggispira PTO 70x110x20 mm		Art. FAG 63896	Art. 62581 OEM 28043280 Cuscinetto volano 17x47x14 mm		Art. FAG 63867

(segue FIAT RUOTE -
NEW HOLLAND)

































Frizioni e loro componenti

CLUTCHES - CLUTCH DISK - BEARING - COUPLING - LEVER - SET-REVISION























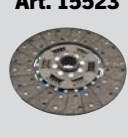

11

11

segue FIAT RUOTE - NEW HOLLAND

<p>1300 - 1300 DT</p>	<p>Art. 15285  </p> <p>OEM 5124399 - 5123062 Meccanismo di movimento Piatto Ø 350 mm</p>	<p>Art. 15567  </p> <p>OEM 5130781 Disco metalceramico a 8 pale con molle parastrappi Ø 350 mm sinterizzato 45x50 - Z.18</p>	<p>Art. 15288  </p> <p>OEM 44016083 Manicotto con cuscinetto reggispinta (solo per modelli 1300 - 1300DT)</p>	
<p>R450S 446 - 466 - 480 500 - 540 - 550 - 566 - 570 - 580 600 - 640 - 666DT - 670 - 680 55.46 - 55.56 - 55.66 - 55.90</p>	<p>Art. Kit 15975  </p> <p>OEM 87689655</p> <p>Kit composto da: - Meccanismo 15929 - Disco PTO 15943 - Cuscinetti 15990 - 63896 - 63867</p>			
<p>60.46 - 60.56 - 60.66 - 60.90 - 65.46 - 65.56 - 65.66 - 65.90 70.56 - 70.66 - 70.90 80.66</p>	<p>Art. 15529  </p> <p>OEM 5154835 Meccanismo a 6 leve completo di disco centrale rigido in ferodo. Fornito senza il disco PTO. Piatto Ø 280 mm (11") Intercambiabile con meccanismo VALEO</p>	<p>Art. 15943  </p> <p>OEM 5145715 - 5154703 Disco PTO rigido in ferodo 280x165x3 mm 25x22EV - Z.10</p>	<p>Art. 15520  </p> <p>OEM 5145715 - 5154703 Disco PTO rigido in ferodo 280x165x3 mm 25x22EV - Z.10</p>	
	<p>Art. 15631  </p> <p>OEM 5145714 - 5155300 Disco centrale rigido in ferodo 280x165x4,4 mm 40x35EV - Z.14</p>	<p>Art. 15990  </p> <p>OEM 5119290 - 5119875 - 5122028 - 87345759 Cuscinetto reggispinta cambio 90x50x22 mm</p>	<p>Art. 15280  </p> <p>OEM 5119290 - 5119875 - 5122028 - 87345759 Cuscinetto reggispinta cambio 90x50x22 mm</p> <p>Art. 15800 Nuova Versione OEM 5197980</p>	
	<p>Art. 15862  </p> <p>OEM 5103178 Cuscinetto reggispinta</p>	<p>Art. 62951  </p> <p>OEM 24905360 - 84455696 Cuscinetto reggispinta PTO 70x110x20 mm</p> <p>Art. FAG 63896</p>	<p>Art. 62581  </p> <p>OEM 28043280 Cuscinetto volano 17x47x14 mm</p> <p>Art. FAG 63867</p>	
<p>(segue FIAT RUOTE - NEW HOLLAND)</p>	<p>Art. 16167  </p> <p>OEM 4993817 Collare</p>	<p>Art. 15863  </p> <p>OEM 599930 Cuscinetto reggispinta</p>	<p>Art. 15751  </p> <p>OEM 26794570 Cuscinetto PTO 65x100x11 mm</p> <p>Per mod: 480 - 500 - 540 - 550 - 600 - 640</p>	

segue FIAT RUOTE - NEW HOLLAND

<p>440-446-450-480-500-540-566-570-580-600-640-666-670-680-766-780-55.48-55.60-55.65-55.70-55.80-55FL/90LP-80.46-80.56-80.60-80.70-80.75-80.85-80.90-55-56N/DT/LM/LP55-66S/DT60-56DT60-66S/DT62-86F/DT65-66S/DT70-56DT70-66S/DT/F/L072-86F/LP/DT80-66S/DT/F82-86F/LP/DT-82-93N/DT82-94N/DT88-93N/DT88-94N/DT55/88N/DT60-88N/DT65-88N/DT65-90N/DT55-4655-9060-4660-66F/LP60-76F60-90-60.93-60.94-65.46-65.56-65.66-65.93-65.94-70.76-70.76F/LP/P-70.88-70.90-72.93-72.94-80.76-80.88-85.90-88.93-88.94</p>	<p>Art. Kit 15929</p>   	<p>OEM Kit composto da: - Meccanismo 15505 - Disco PTO 15943</p>	<p>Per modelli FIAT: 480, 500, 550, 600 e 640 dare cuscinetti 15280, 15751, 62581.</p>	
<p>55-56N/DT/LM/LP55-66S/DT60-56DT60-66S/DT62-86F/DT65-66S/DT70-56DT70-66S/DT/F/L072-86F/LP/DT80-66S/DT/F82-86F/LP/DT-82-93N/DT82-94N/DT88-93N/DT88-94N/DT55/88N/DT60-88N/DT65-88N/DT65-90N/DT55-4655-9060-4660-66F/LP60-76F60-90-60.93-60.94-65.46-65.56-65.66-65.93-65.94-70.76-70.76F/LP/P-70.88-70.90-72.93-72.94-80.76-80.88-85.90-88.93-88.94</p>	<p>Art. Kit 15938</p>      	<p>OEM Kit composto da: - Meccanismo 15505 - Disco PTO 15943 - Cuscinetti 15990 - 63896 - 63867</p>	<p>Non adatto per i modelli FIAT: 480, 500, 550, 600 e 640 (vedi Art.15929).</p>	
<p>MECCANISMO RINFORZATO N.B.: Quando si sostituisce un meccanismo non rinforzato con un meccanismo rinforzato, bisogna sostituire anche il disco PTO.</p>	<p>Art. 15505</p> 	<p>Art. 15943</p> 	<p>OEM 5145715 - 5154703 Disco PTO rigido in ferodo 280x165x3 mm 25x22EV - Z.10</p>	<p>Art. 15520</p>  <p>OEM 5145715 - 5154703 Disco PTO rigido in ferodo 280x165x3 mm 25x22EV - Z.10</p>
<p>Tipo SILA intercambiabile con LUK</p>	<p>Art. 15414</p>  <p>OEM 5145711 Disco centrale metalceramico a 5 pale con molle parastrappi Ø 280 mm sinterizzato 40x35EV - Z.14</p>	<p>Art. 15528</p>  <p>OEM 5162901 Disco centrale metalceramico a 6 pale con molle parastrappi per meccanismo 15505 Ø 280 mm sinterizzato 40x35EV - Z.14</p>	<p>Art. 15523</p>  <p>OEM 5156209 Disco centrale in ferodo con molle parastrappi 280x165x3,5 mm 40x35EV - Z.14</p>	
<p>Art. 15990</p>  <p>OEM 5119290 5119875 - 5122028 - 87345759 Cuscinetto reggispinta cambio 90x50x22 mm</p>	<p>Art. 15280</p>  <p>OEM 5119290 - 5119875 - 5122028 - 87345759 Cuscinetto reggispinta cambio 90x50x22 mm</p>	<p>Art. 15800</p> <p>Nuova Versione OEM 5197980</p>	<p>Art. 62581</p>  <p>OEM 28043280 Cuscinetto volano 17x47x14 mm</p> <p>Art. FAG 63867</p>	
<p>Art. 15862</p>  <p>OEM 5103178 Cuscinetto reggispinta</p>	<p>Art. 15863</p>  <p>OEM 599930 Cuscinetto reggispinta</p>	<p>Art. 62951</p>  <p>OEM 24905360 - 84455696 Cuscinetto reggispinta PTO 70x110x20 mm</p> <p>Art. FAG 63896</p>	<p>Art. 16165</p>  <p>OEM 4954936 Collare Per mod: 540-550-600-640</p>	
<p>Art. 15751</p>  <p>OEM 26794570 Cuscinetto PTO 65x100x11 mm</p> <p>Per mod: 480S-500S-540S-550-600-640</p>			<p>Art. 16167</p>  <p>OEM 4993817 Collare</p>	
<p>(segue FIAT RUOTE - NEW HOLLAND)</p>				

Frizioni e loro componenti

CLUTCHES - CLUTCH DISK - BEARING - COUPLING - LEVER - SET-REVISION

11

11

segue FIAT RUOTE - NEW HOLLAND

550 - 600 -
540 - 540DT -
640 - 640DT -

Tipo VALEO

NB: Frizione non intercambiabile con LUK.
Controllare se i 6 fori di fissaggio sono da 10 mm.

Art. Kit
15661
Valeo



OEM K206
Meccanismo a 6 leve **CON 6 FORI**
Ø 10 mm completo di disco centrale metalceramico e disco PTO
Piatto Ø 280 mm (11")

IMPORTANTE!
PER LA MODIFICA DA 3 A 6 LEVE ORDINARE I SEGUENTI ARTICOLI:
15661 - 15280 - 15751 - 16165 - 16166 - 16187



Art. **15943** OEM 5145715 - 5154703
Disco PTO rigido in ferodo
280x165x3 mm
25x22EV - Z.10

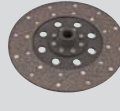

Art. **15520** OEM 5145715 - 5154703
Disco PTO rigido in ferodo
280x165x3 mm
25x22EV - Z.10



Art. **15523** OEM 5156209
Disco centrale in ferodo con molle parastrappi
280x165x3,5 mm
40x35EV - Z.14



Art. **15658** OEM 5152710
Disco PTO rigido in ferodo
280x165x3 mm
25x22EV - Z.10



Art. **15414** OEM 5011873
5160418
Disco centrale metalceramico a 5 pale con molle parastrappi
Ø 280 mm sinterizzato
40x35EV - Z.14



Art. **15657** OEM 5120435 - 5150653
Disco centrale metalceramico a 5 pale, rigido
Ø 280 mm sinterizzato
40x35EV - Z.14



Art. **15751** OEM 26794570
Cuscinetto PTO
65x100x11 mm



Art. **15990** OEM 5119290
5119875 - 5122028 - 87345759
Cuscinetto reggispinta cambio 90x50x22 mm



Art. **15280** OEM 5119290 - 5119875 - 5122028 - 87345759
Cuscinetto reggispinta cambio 90x50x22 mm



Art. **16165** OEM 4954936
Collare



Art. **16166** OEM 597149
Collare



Art. **16187** OEM 15971734
Vite
10x1,25x95 - R10.9

680 - 680DT -
780 - 780DT
570 - 570DT
580 - 580DT
670 - 670DT

Art. Kit
15659
Valeo

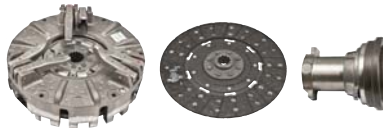

OEM 1930987
Meccanismo a 6 leve **CON 6 FORI**
Ø 10 mm completo di disco centrale metalceramico a 5 pale fornito con disco PTO e cuscinetto reggispinta.
Piatto Ø 280 mm (11")



Art. **15943** OEM 5145715 - 5154703
Disco PTO rigido in ferodo
280x165x3 mm
25x22EV - Z.10



Art. **15658** OEM 5152710
Disco PTO rigido in ferodo
280x165x3 mm
25x22EV - Z.10



Art. **15657** OEM 5120435 - 5150653
Disco centrale metalceramico a 5 pale, rigido
Ø 280 mm sinterizzato
40x35EV - Z.14



Art. **15990** OEM 5119290 - 5119875 - 5122028 - 87345759
Cuscinetto reggispinta cambio 90x50x22 mm



Art. **15280** OEM 5119290 - 5119875 - 5122028 - 87345759
Cuscinetto reggispinta cambio 90x50x22 mm



Art. **15660** OEM 5177194
Cuscinetto reggispinta



Art. **16187** OEM 15971734
Vite
10x1,25x95 - R10.9

880.5 - 880.5 DT -
980 - 90.90 -
100.90 - 110.90

Dal febbraio 1980 in avanti

Originale VALEO

Art. Kit
15650
Valeo



OEM 1930988
- Meccanismo a 6 leve completo di disco centrale metalceramico rigido
- Piatto Ø 310 mm (12")



Art. **15261** OEM 5122560 - 5144011
Disco centrale metalceramico rigido a 6 pale Ø 310 sinterizz.
45x40EV - Z.16



Art. **15651** OEM 5114522 - 5160434
Disco PTO rigido in ferodo
310x175x3,5 mm - 28x24EV - Z.10



Art. **15114** OEM 5114522 - 5160434
Disco PTO rigido in ferodo
310x175x3,5 mm
28x24EV - Z.10



Art. **16186** OEM 15971831
Vite
10x1,25x100 - R10.9























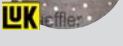















Art. **15864** OEM 44011614
Cuscinetto reggispinta Frizione con diaframma
55x92x22 mm (tolleranza 8mm)



Art. **15866** OEM 5177197
Cuscinetto reggispinta completo doppio per frizione a 6 leve

(segue FIAT RUOTE - NEW HOLLAND)

segue FIAT RUOTE - NEW HOLLAND

<p>90.90N/DT/F/S - 90.95 - 90/S - 100.90N/DT/F/S - 110.90N/DT/S - 880.5N/DT - 880 II° tipo - 980</p> <p>MECCANISMO RINFORZATO</p> <p>N.B.: Quando si sostituisce un meccanismo non rinforzato con un meccanismo rinforzato, bisogna sostituire anche il disco PTO.</p>	<p>Art. Kit 15932</p>    <p>OEM</p> <p>Kit composto da: - Meccanismo 15530 - Disco PTO 15966</p>		
	<p>Art. Kit 15978</p>       <p>OEM</p> <p>Kit composto da: - Meccanismo 15530 - Disco PTO 15966 - Cuscinetti 15990 - 63897 - 63869</p>		
	<p>Art. 15530</p>  <p>OEM 5163936 Meccanismo a 6 leve completo di disco centrale metalceramico a 7 pale. Fornito senza il disco PTO. Piatto Ø 310 mm (12") Intercambiabile con meccanismo VALEO</p>	<p>Art. 15966</p>  <p>OEM 5144741 - 5154514 Disco PTO rigido in ferodo, per meccanismo 15530 310x190x3 mm 28x24EV - Z.10</p>	<p>Art. 15532</p>  <p>OEM 5144741 - 5154514 Disco PTO rigido in ferodo, per meccanismo 15530 310x190x3 mm 28x24EV - Z.10</p>
	<p>Art. 15531</p>  <p>OEM 5163937 Disco centrale metalceramico rigido a 7 pale per meccanismo 15530 Ø 310 sinterizzato (12") 45x40EV - Z.16</p>	<p>Art. 15990</p>  <p>OEM 5119290 - 5119875 - 5122028 - 87345759 Cuscinetto reggispinta cambio 90x50x22 mm</p>	<p>Art. 15280</p>  <p>OEM 5119290 - 5119875 - 5122028 - 87345759 Cuscinetto reggispinta cambio 90x50x22 mm</p> <p>Art. 15800</p> <p>Nuova Versione OEM 5197980</p>
		<p>Art. 62952</p>  <p>OEM 5112084 - 47127081 Cuscinetto reggispinta PTO 75x115x20 mm</p> <p>Art. FAG 63897</p>	<p>Art. 62583</p>  <p>OEM 28042740 Cuscinetto volano 20x47x14 mm</p> <p>Art. FAG 63869</p>
<p>1180 - 1180 DT</p> <p>Originale VALEO</p>	<p>Art. 15665</p>  <p>OEM 1930989 Meccanismo a 6 leve completo di disco metalceramico rigido, fornito con disco PTO e cuscinetto reggispinta. Piatto Ø 310 mm (12")</p>	<p>Art. 15374</p>  <p>OEM 5116492 Disco centrale metalceramico rigido a 8 pale Ø 310 mm sinterizzato 50x45EV - Z.18</p>	<p>Art. 15277</p>  <p>OEM 5160418 Disco PTO rigido in ferodo 310x175x3,5 mm 32x28EV Z.11</p>
	<p>Art. 16186</p>  <p>OEM 15971831 Vite 10x1,25x100 - R10.9</p>	<p>Art. 15969</p>  <p>OEM 5102263 - 5160410 Disco PTO rigido in ferodo 280x165x3,5 mm 28x24EV - Z.10</p>	
<p>1180 - 1180 DT - 115.90 N/DT</p>	<p>Art. Kit 15534</p>       <p>OEM 5144661 Kit composto da: - Meccanismo - Disco PTO 15970 - Cuscinetti 15756 - 15755 - 63869</p>		
	<p>Art. Kit 16143</p>    <p>OEM 73328284 Kit composto da: - Meccanismo - Disco PTO</p>		
	<p>Art. 15970</p>  <p>OEM 5154551 Disco PTO rigido in ferodo 310x190x4 mm 32x28EV - Z.11</p>	<p>Art. 15536</p>  <p>OEM 5154551 Disco PTO rigido in ferodo 310x190x4 mm 32x28EV - Z.11</p>	<p>Art. 15535</p>  <p>OEM 5143411 Disco centrale metalceramico rigido a 8 pale Ø 310 mm sinterizzato 50x45EV - Z.18</p>
<p>(segue FIAT RUOTE - NEW HOLLAND)</p>	<p>Art. 15756</p>  <p>OEM 44016827 Cuscinetto reggispinta PTO 106x139,5x25 mm</p>	<p>Art. 15755</p>  <p>OEM 5120853 Cuscinetto reggispinta cambio 96,5x65x23,5 mm</p>	<p>Art. 62583</p>  <p>OEM 28042740 Cuscinetto volano 20x47x14 mm</p> <p>Art. FAG 63869</p>











































Frizioni e loro componenti

CLUTCHES - CLUTCH DISK - BEARING - COUPLING - LEVER - SET-REVISION







































11

11

segue FIAT RUOTE - NEW HOLLAND

160.90 - 160.90 DT TURBO - 180.90 - 180.90 DT TURBO - (CENTRAGGIO ESTERNO) 1580 - 1880	Art. Kit 15939   	OEM 5140361 Kit frizione con meccanismo a 6 leve e disco Ø 310 mm		
	Art. 15537 	OEM 5123061-5128011 Disco metalceramico a 6 pale con molle parastrappi Ø 310 mm sinterizzato 50x45EV - Z.18	Art. 15275  	OEM 5141934 Frizione multidisco PTO 5" 1/2 P.T.O.
	Art. 16200   	OEM 5143858 Manicotto reggispinta con cuscinetto	Art. 84025  	Art. 84026 Pompa idraulica per 15275 spessore 40,5mm Art. 15755 
1280N/DT - 1380N/DT - 1580N/DT - 1880N/DT - 1180 MONODISCO 115.90N/DT 130.90N/DT 140.90N/DT	Art. Kit 15926   	OEM Kit composto da: - Meccanismo 15285 - Disco 15967		
	Art. 15285  	OEM 5124399 - 5123062 Meccanismo di movimento Piatto Ø 350 mm	Art. 15967  	OEM 5118453 Disco presa di movimento con 8 pale 69x77x4 mm metalceramica e con molle parastrappi Ø 352 mm sinterizzato 45x50 mm - Z.18
	Art. 15275  	OEM 5141934 Frizione multidisco PTO 5" 1/2 P.T.O.	 	Art. 84025 Pompa idraulica per 15275 spessore 30mm Art. 84026 Pompa idraulica per 15275 spessore 40,5mm
	Art. 15801  	OEM 5121414 Manicotto con cuscinetto VALEO	Art. 15288  	Art. 15755 
WINNER F100DT - F110DT - F115 - F120DT TM 110 - 115 - 120 - 125 - 130 - 140 FORD 8160 - 8260 - 8360 - M100 - M115 - M135	Art. 15564  	OEM 5177618 - 5154418 - 133021410 Meccanismo con molle a diaframma Piatto Ø 330 mm	Art. 15565  	Art. 15753  
	Art. 15566  	OEM 5150079-5177620 Meccanismo con molle a diaframma Piatto Ø 350 mm	Art. 15968  	Art. 15753  
WINNER F130N/DT F140N/DT 8360 FORD 8160 - 8260 - 8360 - M100 - M115 - M135 - TM110 - TM120 - TM130 - TM135 - TM140 - TM150	Art. Kit 15927   	OEM Kit composto da: - Meccanismo 15566 - Disco 15968		
(segue FIAT RUOTE - NEW HOLLAND)				

segue FIAT RUOTE - NEW HOLLAND

35/66	Art. Kit 16030   	OEM 44907618 Kit composto da: - Meccanismo 15867 - Disco PTO 15868		
	Art. 15867  	OEM 44907615 Meccanismo a 6 leve completo di disco di avanzamento 31x35 - Z.18 Piatto Ø 230 mm	Art. 15868  	OEM 44907617 Disco PTO Ø 225 mm 14,4x17 - Z.9
	Art. 63363  	OEM 24905350 Cuscinetto PTO 100x65x18 mm	Art. FAG 63895	
	Art. 16168  	OEM 5124762 Collare	Art. 15990  	OEM 5119290 5119875 - 5122028 - 87345759 Cuscinetto reggispinta cambio 90x50x22 mm
	Art. 15280 	OEM 5119290 - 5119875 - 5122028 - 87345759 Cuscinetto reggispinta cambio 90x50x22 mm		
45.66S/DT/N/V - 45.76V - 50.66N/S/DT/V - 50.86V/S/DT - 55.86F/V/S/DT 45.76V - 55.76F/V/DT - 55.66F/V/DT - 386 - 3435 - 3830 - 3935 FORD 3435 - 3830 - 3935	Art. Kit 16032      	OEM Kit composto da: - Meccanismo 15552 - Disco PTO 15971 - Cuscinetti 15990 - 63895 - 63867		
	Art. Kit 16031   	OEM Kit composto da: - Meccanismo 15552 - Disco PTO 15971		
	Art. 15552  	OEM 5138144-5154513-5171493-5139339 Meccanismo a 6 leve completo di disco centrale in ferodo, senza il disco di PTO Piatto Ø 250 mm (10") Intercambiabile con meccanismo VALEO	Art. 15971  	OEM 5128074-5154799 Disco PTO rigido in ferodo 250x155x3,5 mm 22x19EV - Z.13
	Art. 15554 	OEM 5128074-5154799 Disco PTO rigido in ferodo 250x155x3,5 mm 22x19EV - Z.13		
	Art. 16168  	OEM 5124762 Collare	Art. 15553 	OEM 5127508-5169423 Disco centrale in ferodo con molle parastrappi 250x155x4 mm 35x31EV - Z.18
	Art. 62581  	OEM 28043280 Cuscinetto volano 17x47x14 mm	Art. FAG 63867	
	Art. 63363  	OEM 24905350 Cuscinetto PTO 100x65x18 mm	Art. 15990  	OEM 5119290 5119875 - 5122028 - 87345759 Cuscinetto reggispinta cambio 90x50x22 mm
	Art. FAG 63895		Art. 15280 	OEM 5119290 - 5119875 - 5122028 - 87345759 Cuscinetto reggispinta cambio 90x50x22 mm

(segue FIAT RUOTE - NEW HOLLAND)















































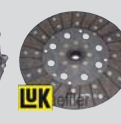

Frizioni e loro componenti

CLUTCHES - CLUTCH DISK - BEARING - COUPLING - LEVER - SET-REVISION

11



































11

segue FIAT RUOTE - NEW HOLLAND

<p>446 - 466 - 566 - 666 55.46 - 55.56 - 55.66 55.90 - 60.46 - 60.56 60.66 - 60.90 - 65.46 65.56 - 65.66 - 65.90 70.56 - 70.66 - 80.66</p>	<p>Art. Kit 15976</p>      			<p>OEM 87689657</p> <p>Kit composto da: - Meccanismo 15544 - Disco PTO 15943 - Cuscinetti 15990 - 63896 - 63867</p>
<p>Art. 15544</p>  	<p>OEM 5145706 - 5154879 - 5171137 - Meccanismo a 6 leve completo di disco centrale in ferodo senza il disco PTO. - Piatto Ø 280 mm (11")</p>	<p>Art. 15943</p>  	<p>Art. 15520</p>  <p>OEM 5145715 - 5154703 Disco PTO rigido in ferodo 280x165x3 mm 25x22EV - Z.10</p>	
<p>Art. 15147</p>  	<p>OEM 5171053 - 5155304 Disco centrale in ferodo con molle parastrappi 280x165x4,4 mm 40x35EV - Z.14</p>	<p>Art. 15990</p>  	<p>Art. 15280</p>  <p>OEM 5119290 - 5119875 - 5122028 - 87345759 Cuscinetto reggispinta cambio 90x50x22 mm</p> <p>Art. 15800</p> <p>Nuova Versione OEM 5197980</p>	
	<p>Art. 62951</p>  <p>OEM 24905360 - 84455696 Cuscinetto reggispinta PTO 70x110x20 mm</p> <p>Art. FAG 63896</p>	<p>Art. 62581</p>  <p>OEM 28043280 Cuscinetto volano 17x47x14 mm</p> <p>Art. FAG 63867</p>		
<p>55 - 60 S/DT 56 - 66 S 60 - 86 F/DT/V/S 70 - 86 V/DT FORD 4135</p>	<p>Art. Kit 15934</p>      			<p>OEM 87689658</p> <p>Kit composto da: - Meccanismo 15869 - Disco PTO 15870 - Cuscinetti 63895 - 15990 - 63867</p>
<p>Art. 15869</p>  	<p>OEM 5171494 Meccanismo frizione Piatto Ø 280 mm (11") con disco 35x31 mm - Z.18</p>	<p>Art. 15870</p>  	<p>Art. 62581</p>  <p>OEM 28043280 Cuscinetto volano 17x47x14 mm</p> <p>Art. FAG 63867</p>	
<p>Art. 15990</p>  	<p>OEM 5119290 - 5119875 - 5122028 - 87345759 Cuscinetto reggispinta cambio 90x50x22 mm</p>	<p>Art. 15280</p>  	<p>Art. 63363</p>  <p>OEM 24905350 Cuscinetto PTO 100x65x18 mm</p> <p>Art. FAG 63895</p>	
		<p>Art. 16168</p>  <p>OEM 5124762 Collare</p>		
<p>5635 - 4835 - 4635 - 6635 - 7635 L60 - L65 - L75 - L85 L95 TL65A</p>	<p>Art. Kit 16069</p>      			<p>OEM 87689673</p> <p>Kit composto da: - Meccanismo 15782 - Disco PTO 15783 - Cuscinetti 15990 - 63897 - 63867</p>
<p>Art. 15782</p>  	<p>OEM 5167923 Meccanismo a 6 leve completo di disco centrale in ferodo senza il disco PTO Piatto Ø 280 mm</p>	<p>Art. 15783</p>  	<p>Art. 15990</p>  <p>OEM 5119290 - 5119875 - 5122028 - 87345759 Cuscinetto reggispinta cambio 90x50x22 mm</p>	
<p>Art. 62581</p>  	<p>OEM 500311249 Cuscinetto volano 17x47x14 mm</p> <p>Art. FAG 63867</p>	<p>Art. 62952</p>  <p>OEM 47127081 Cuscinetto reggispinta PTO 75x115x20 mm</p> <p>Art. FAG 63897</p>	<p>Art. 15280</p>  <p>OEM 5119290 - 5119875 - 5122028 - 87345759 Cuscinetto reggispinta cambio 90x50x22 mm</p>	

(segue FIAT RUOTE - NEW HOLLAND)

segue FIAT RUOTE - NEW HOLLAND

<p>4835 L65 TL70</p>	<p>Art. Kit 16034</p>   <p>OEM 87689674</p> <p>Kit composto da: - Meccanismo 15784 - Disco PTO 15785 - Cuscinetti 15990 - 63897 - 63867</p>			
	<p>Art. 15784</p>   <p>OEM 5167933 Meccanismo a 6 leve completo di disco centrale in ferodo senza il disco PTO Piatto Ø 310 mm</p>	<p>Art. 15785</p>   <p>OEM 5167937 Disco PTO rigido in ferodo senza molleggio Ø 310 mm - 22x25 Z10</p>	<p>Art. 62952</p>   <p>OEM 5112084 - 47127081 Cuscinetto reggispinta PTO 75x115x20 mm</p>	
	<p>Art. 15990</p>   <p>OEM 5119290 - 5119875 - 5122028 - 87345759 Cuscinetto reggispinta cambio 90x50x22 mm</p>	<p>Art. 15280</p>   <p>OEM 5119290 - 5119875 - 5122028 - 87345759 Cuscinetto reggispinta cambio 90x50x22 mm</p>	<p>Art. 62581</p>   <p>OEM 28043280 Cuscinetto volano 17x47x14 mm</p>	
<p>6635 - 5635 - 7635 T4.105 - T4.75 - T4.85 - T4.95 T5030 - T5040 TD60D PLUS - TD70D PLUS - TD80D PLUS - TD90D PLUS - TD95D PLUS TL100 - TL95 - TL80 - TL75 - TL90 - TL85 TL70A - TL80A - TL90A TL75E - TL85E - TL95E</p>	<p>Art. Kit 16056</p>   <p>OEM 9973687</p> <p>Kit composto da: - Meccanismo 15786 - Disco PTO 15785 - Cuscinetti 15990 - 63897 - 63867</p>			
	<p>Art. Kit 15981</p>   <p>OEM</p> <p>Kit composto da: - Meccanismo 15786 - Disco PTO 15792 - Cuscinetti 15990 - 63896 - 63867</p>			
	<p>Art. 15786</p>   <p>OEM 5189875-47126706-87716719 Meccanismo a 6 leve completo di disco centrale cerametallico 6 pale senza il disco PTO Piatto Ø 310 mm</p>	<p>Art. 15792</p>   <p>OEM 5176450 - 47134874 Disco PTO rigido in cerametallico 4 pale Ø 280 mm - 22x25 Z10</p>	<p>Art. 15785</p>   <p>OEM 5167937 Disco PTO rigido in ferodo senza molleggio Ø 310 mm - 22x25 Z10</p>	
	<p>Art. 62951</p>   <p>OEM 24905360 - 84455696 Cuscinetto reggispinta PTO 70x110x20 mm</p>	<p>Art. 15990</p>   <p>OEM 5119290 - 5119875 - 5122028 - 87345759 Cuscinetto reggispinta cambio 90x50x22 mm</p>	<p>Art. 15280</p>   <p>OEM 5119290 - 5119875 - 5122028 - 87345759 Cuscinetto reggispinta cambio 90x50x22 mm</p>	
<p>(segue FIAT RUOTE - NEW HOLLAND)</p>		<p>Art. 62952</p>   <p>OEM 47127081 Cuscinetto reggispinta PTO 75x115x20 mm</p>	<p>Art. 62581</p>   <p>OEM 28043280 Cuscinetto volano 17x47x14 mm</p>	























Frizioni e loro componenti

CLUTCHES - CLUTCH DISK - BEARING - COUPLING - LEVER - SET-REVISION







































11

11

segue FIAT RUOTE - NEW HOLLAND

T5030 - T5040 - T5050 - T5060 - TL100 - TL100A - TL70 - TL70A - TL80 - TL80A - TL90 - TL90A - L60 - L65 - L75 - L85 - L85 - L95 - 4635 - 4835 - 5635 - 6635 - 7635 FORD L75 - L85 - L95 - T5030 - T5040 - T5060	Art. Kit 16075  	OEM Kit composto da: - Meccanismo 15787 - Disco avanzamento 15788		
	Art. 15787  OEM 5167939 5189823 87575337 Meccanismo Piatto Ø 310 mm	Art. 15788  OEM 5167936 5179851 - 5189825 Disco di avanzamento cerametallico doppio segmento a 6 pale Ø 310 mm - 40x45 mm Z16	Art. 16009  OEM 5166287 Manicotto con reggispinta	
	Art. 16076  OEM 47133433 Damper Ø 136 mm 22x25 mm - Z10	Art. 16018  OEM 5181872 Parastrappo Ø 116 mm 22x15 mm - Z10		
TD4020F - TD4030F - TD4040F TD5010 - TD5020 - TD5030 TD5.75 - TD5.80 - TD5.85 - TD5.90 - TD60D - TD70D - TD80D - TD90D	Art. Kit 16033  	OEM 5097927 - 84177326 - 84328337 Kit composto da: - Meccanismo 15874 - Disco PTO 15943 - Cuscinetti 15990 - 63896 - 63867		
	Art. 15874  OEM 84177326 Meccanismo frizione a 6 leve con disco interno a 6 pale Z.14 Piatto Ø 280 mm (11")	Art. 15943  OEM 5145715 - 5154703 Disco PTO rigido in ferodo 280x165x3 mm 25x22EV - Z.10	Art. 15520  OEM 5145715 - 5154703 Disco PTO rigido in ferodo 280x165x3 mm 25x22EV - Z.10	
		Art. 15990  OEM 5119290 - 5119875 - 5122028 - 87345759 Cuscinetto reggispinta cambio 90x50x22 mm	Art. 15280  OEM 5119290 - 5119875 - 5122028 - 87345759 Cuscinetto reggispinta cambio 90x50x22 mm	
		Art. 62951  Art. FAG 63896 OEM 24905360 - 84455696 Cuscinetto reggispinta PTO 70x110x20 mm	Art. 62581  Art. FAG 63867 OEM 28043280 Cuscinetto volano 17x47x14 mm	
TD 5040-5050 TD 60/D-70/D-80/D- 90/D-95/D/PLUS	Art. 15876  OEM 5092803 Meccanismo frizione a 6 leve con disco interno a 6 pale Z.16 Piatto Ø 310 mm (12")	Art. 15877  OEM 5089337 Disco frizione Ø 310 mm 22x25 mm - Z.10	Art. 62951  Art. FAG 63896 OEM 24905360 - 84455696 Cuscinetto reggispinta PTO 70x110x20 mm	
	Art. 15990  OEM 5119290 - 5119875 - 5122028 - 87345759 Cuscinetto reggispinta cambio 90x50x22 mm	Art. 15280  OEM 5119290 - 5119875 - 5122028 - 87345759 Cuscinetto reggispinta cambio 90x50x22 mm	Art. 62581  Art. FAG 63867 OEM 28043280 Cuscinetto volano 17x47x14 mm	
	(segue FIAT RUOTE - NEW HOLLAND)		Art. 16186  OEM 15971831 Vite 10x1,25x100 - R10.9	

segue FIAT RUOTE - NEW HOLLAND

SERIE TN (3 cil.) TN55 - 55V - 55S - 55D TN60A - 60VA - 60SA - 60DA TN65 - 65V - 65S - 65D TN70 TN75 - 75N/V	Art. Kit 15977      	OEM Kit composto da: - Meccanismo 15789 - Disco PTO 15792 - Cuscinetti 15990 - 63897 - 63867	
	Art. 15789  OEM 5186552 5196816 Meccanismo a 6 leve completo di disco centrale Piatto Ø 280 mm	Art. 15792  OEM 5176450 - 47134874 - 5196819 Disco PTO rigido in cerametallico 4 pale Ø 280 mm - 22x25 Z10	
		Art. 15990  OEM 5119290 - 5119875 - 5122028 - 87345759 Cuscinetto reggispinta cambio 90x50x22 mm	Art. 15280  OEM 5119290 - 5119875 - 5122028 - 87345759 Cuscinetto reggispinta cambio 90x50x22 mm
		Art. 62952  OEM 5112084 - 47127081 Cuscinetto reggispinta PTO 75x115x20 mm Art. FAG 63897	Art. 62581  OEM 28043280 Cuscinetto volano 17x47x14 mm Art. FAG 63867
SERIE TN (3 cil.) TN70/A/NA/VA/D/DA/S TN75/A/N/NA/V/VA/D/ DA/S TN95NA/VA	Art. Kit 16035      	OEM 73328271 Kit composto da: - Meccanismo 15793 - Disco PTO 15792 - Cuscinetti 15990 - 63897 - 63867	
	Art. 15793  OEM 5196818-47134898 Meccanismo a 6 leve completo di disco centrale cerametallico 5 pale Piatto Ø 280 mm	Art. 15792  OEM 5176450 - 47134874 - 5196819 Disco PTO rigido in cerametallico 4 pale Ø 280 mm - 22x25 Z10	
		Art. 15990  OEM 5119290 - 5119875 - 5122028 - 87345759 Cuscinetto reggispinta cambio 90x50x22 mm	Art. 15280  OEM 5119290 - 5119875 - 5122028 - 87345759 Cuscinetto reggispinta cambio 90x50x22 mm
		Art. 62952  OEM 5112084 - 47127081 Cuscinetto reggispinta PTO 75x115x20 mm Art. FAG 63897	Art. 62581  OEM 28043280 Cuscinetto volano 17x47x14 mm Art. FAG 63867
SERIE TN (4 cil.) TN65F TN75 TN80F TN90F TN85A/DA/FA/SA TN95A/DA/FA/NA/VA T4030 T4040 T4050	Art. Kit 16036      	OEM 87689675 Kit composto da: - Meccanismo 15796 - Disco PTO 15792 - Cuscinetti 15990 - 63897 - 63867	
	Art. Kit 15930   	OEM Kit composto da: - Meccanismo 15796 - Disco PTO 15792	
	Art. 15796  OEM 87732504 5181421 - 5196813 - 47134895 - 87732503 - 87732506 Meccanismo a 6 leve completo di disco centrale cerametallico 5 pale Piatto Ø 280 mm 35x39,8 mm - Z.14	Art. 15990  OEM 5119290 - 5119875 - 5122028 - 87345759 Cuscinetto reggispinta cambio 90x50x22 mm	Art. 15280  OEM 5119290 - 5119875 - 5122028 - 87345759 Cuscinetto reggispinta cambio 90x50x22 mm
	Art. 15792  OEM 5176450 - 47134874 - 5196819 Disco PTO rigido in cerametallico 4 pale Ø 280 mm - 22x25 Z10	Art. 62952  OEM 5112084 - 47127081 Cuscinetto reggispinta PTO 75x115x20 mm Art. FAG 63897	Art. 62581  OEM 28043280 Cuscinetto volano 17x47x14 mm Art. FAG 63867

(segue FIAT RUOTE -
NEW HOLLAND)

































Frizioni e loro componenti

CLUTCHES - CLUTCH DISK - BEARING - COUPLING - LEVER - SET-REVISION

11

11

segue FIAT RUOTE - NEW HOLLAND

















<p>SERIE TN (4 cil.) con POWERSHIFT TN55D/S/V - TN60A/DA/SA/VA TN65D/F/N/S/V - TN70A/D/DA/F/S/SA/ VA - TN75A/D/DA/FA/N/ NA/S/SA/V/VA - TN80F - TN90F - TN95F/FA/NA/VA T4020 - T4030 - T4040 T4.75F - T4.85F</p>	<p>Art. Kit 16073</p>     		<p>OEM 47134873 - 47134884 - 87732490 - 5196770 - 47134886 Kit composto da: - Meccanismo 15797 - Disco PTO 15792 - Cuscinetti 63897 - 63866</p>		
	<p>Art. 15797</p>  	<p>OEM 5186548 - 5186550 - 47134884 - 5196770 - 47134873 - 87732485 - 47134886 Meccanismo Piatto Ø 280 mm</p>	<p>Art. 15792</p>  	<p>OEM 5176450 - 47134874 - 5196819 Disco PTO rigido in cerametallico 4 pale Ø 280 mm - 22x25 Z10</p>	<p>Art. 62581</p>  <p>OEM 28043280 Cuscinetto volano 17x47x14 mm</p> <p>Art. FAG 63867</p> <p>Solo per serie TN.</p>
			<p>Art. 62580</p>  <p>OEM 47133709 - 87729147 - 87302841 Cuscinetto 17x40x12 mm</p> <p>Art. FAG 63866</p>	<p>Art. 62952</p>  <p>OEM 5112084 - 47127081 Cuscinetto reggispinta PTO 75x115x20 mm</p> <p>Art. FAG 63897</p>	
<p>TCE 40 - 45 - 50 - 55 T3010 - T3020 - T3030</p>	<p>Art. Kit 15899</p>   		<p>OEM 87291158 - 9976054 Kit composto da: - Meccanismo - Disco PTO 15907</p>		
	<p>Art. 15906</p>  	<p>OEM 87289033 Disco frizione interno Ø 225 mm 27x30 mm - Z.16</p>	<p>Art. 15907</p>  	<p>OEM Disco PTO Ø 225 mm 14x17 - Z.9</p>	<p>Art. 63363</p>  <p>OEM Cuscinetto PTO 100x65x18 mm</p> <p>Art. FAG 63895</p>
	<p>Art. 15990</p>  	<p>OEM Cuscinetto reggispinta cambio 90x50x22 mm</p>	<p>Art. 15280</p>  	<p>OEM 5119290 - 5119875 - 5122028 - 87345759 Cuscinetto reggispinta cambio 90x50x22 mm</p>	<p>Art. 62577</p>  <p>OEM Cuscinetto volano 15x35x11 mm</p> <p>Art. FAG 63863</p>
<p>T3040 TCE55</p>	<p>Art. Kit 16203</p>   		<p>OEM Kit composto da: - Meccanismo - Disco PTO 15907</p>		
	<p>Art. 15990</p>  	<p>OEM 5119290 5119875 - 5122028 - 87345759 Cuscinetto reggispinta cambio 90x50x22 mm</p>	<p>Art. 63363</p>  <p>OEM Cuscinetto PTO 100x65x18 mm</p> <p>Art. FAG 63895</p>	<p>Art. 62577</p>  <p>OEM Cuscinetto volano 15x35x11 mm</p> <p>Art. FAG 63863</p>	

(segue FIAT RUOTE -
NEW HOLLAND)





Frizioni e loro componenti

CLUTCHES - CLUTCH DISK - BEARING - COUPLING - LEVER - SET-REVISION

segue FIAT RUOTE - NEW HOLLAND

T3.50F, T3.55F, T3.60F, T3.65F, T3.70F, T3.75F, T3.80F	Art. Kit 16260 		OEM 47797593 - 84233502 Kit frizione completo Ø XXX composto da: - Meccanismo - Disco PTO - Cuscinetto avanzamento 15990 - Cuscinetto PTO 63897 - Cuscinetto Volano 63867			
T4.75, T4.85 T5.75, T5.85 TD4.80F, TD4.90F TD4030F, TD4040F TD85F	Art. Kit 16212 		OEM 84342957 Kit composto da: - Meccanismo - Disco			
	Art. 62952  Art. FAG 63897	OEM 47127081 Cuscinetto reggispinta PTO 75x115x20 mm	Art. 15280  Art. LUK 15990	OEM 87345759 Cuscinetto reggispinta cambio 90x50x22 mm	Art. 62580  Art. FAG 63866	OEM 47133709 - 87729147 - 87302841 Cuscinetto 17x40x12 mm
T4.55, T4.65, T4.75	Art. Kit 16217 		OEM 84233502 Kit composto da: - Meccanismo - Disco			
	Art. 15280  Art. LUK 15990	OEM 87345759 Cuscinetto reggispinta cambio 90x50x22 mm	Art. 62952  Art. FAG 63897	OEM 47127081 Cuscinetto reggispinta PTO 75x115x20 mm	Art. 62580  Art. FAG 63866	OEM 87729147 - 87302841 Cuscinetto 17x40x12 mm
T4.105F T4.110F TD5.105 TD5.115	Art. Kit 16235 		OEM 84427009 Kit completo frizione composto da: - Meccanismo - Disco PTO - Cuscinetto PTO 63897 - Cuscinetto Volano 64536			
T4.100LP/105F/105N /105V/110F/110LP/ 110N/110V T4060 F/N/V TD4.100F	Art. Kit 16259 		OEM 84424850 Kit frizione completo Ø 280 composto da: - Disco PTO - Cuscinetto avanzamento 15990 - Cuscinetto PTO 63897 - Cuscinetto Volano 63867			

FIAT CINGOLI

25C - CL - CF - CS	Art. 15206 	OEM 544583 Anello frizione di sterzo - dentatura esterna 219,2x152x6 mm 71 denti	
70 C - CL - 80 C - CA - 90 C - 100 C - 120 C	Art. 15171 	OEM 76033269 Anello frizione di sterzo - dentatura esterna 309x214x5,4-101 denti	Art. 15764  OEM 7602.8177 Anello per frizione centrale - dentatura esterna 392x142x15-54 denti
311C - 332C - 351C - 352C (segue FIAT CINGOLI)	Art. 15417 	OEM 568911 Anello frizione di sterzo - dentatura esterna 219,2x152x4,7 mm 71 denti	











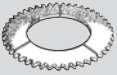

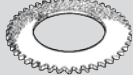

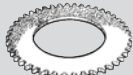









Frizioni e loro componenti

CLUTCHES - CLUTCH DISK - BEARING - COUPLING - LEVER - SET-REVISION

11









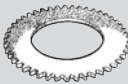

11

segue FIAT CINGOLI







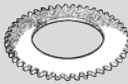
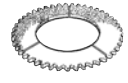

355C - 400C - 411C - CL - 451C - 455C - CDAL - C SUPER - 505C - C SUPER	Art. 15173  OEM588433 Anello per frizione centrale - dentatura esterna 277x156x10 (1/3 T) 45 denti	Art. 15388  OEM571707 Anello per frizione cambio 88x48x4,5 mm 8 fori	Art. 15176  OEM 5109934 - 5109937 - 5161615 Anello per frizione di sterzo - in tessuto - dentatura esterna 239x180x4,8 - 28 denti
		Art. 15389  OEM 5109934 - 5109937 - 5161615 Anello per frizione di sterzo - dentatura interna 229x171x2 - 21 denti	Art. 15668  OEM 5109934 - 5109937 - 5161615 Anello per frizione di sterzo - sinterizzato - dentatura esterna 239x180x4 - 28 denti
465 VIGNETO - 465 C FRUTTETO	Art. 15317  OEM 5122253-5127787 Anello per frizione centrale - dentatura esterna - 45 denti 273x166x7 mm	Art. 15176  OEM 5109937 5109934-5161615 Anello per frizione di sterzo - in tessuto - dentatura esterna 239x180x4,8 - 28 denti	Art. 15668  OEM 5109934 - 5109937 - 5161615 Anello per frizione di sterzo - sinterizzato - dentatura esterna 239x180x4 - 28 denti
		Art. 15389  OEM 566519 Anello per frizione di sterzo - dentatura interna 229x171x2 - 21 denti	
555C - 565C - 605C - 605C SUPER	Art. 15177  OEM 596511 Anello per frizione centrale - dentatura esterna 277x166x7 mm 45 denti	Art. 15388  OEM 571707 Anello per frizione cambio 88x48x4,5 mm 8 fori	Art. 15176  OEM 5109934 - 5109937 - 5161615 Anello per frizione di sterzo - in tessuto - dentatura esterna 239x180x4,8 mm 28 denti
		Art. 15389  OEM 566519 Anello per frizione di sterzo - dentatura interna 229x171x2 mm 21 denti	Art. 15668  OEM 5109934 - 5109937 - 5161615 Anello per frizione di sterzo - sinterizzato - dentatura esterna 239x180x4 mm 28 denti
565 C - 665 C - 765 C	Art. 15317  OEM5122253-5127787 Anello per frizione centrale - dentatura esterna 273x166x7 mm 45 denti	Art. 15582  OEM 5112063 - 5169148 Anello per frizione cambio 116x73x4,5 mm 4 fori	Art. 15583  OEM 5121348 Anello per disco PTO 280x165x3,5 mm 24 fori
	Art. 15176  OEM 5109934 5109937 - 5161615 Anello per frizione di sterzo in tessuto - dentatura esterna 239x180x4,8 mm 28 denti		Art. 15389  OEM 566519 Anello per frizione di sterzo - dentatura interna 229x171x2 mm 21 denti
			Art. 15668  OEM 5109934 - 5109937 - 5161615 Anello per frizione di sterzo - sinterizzato - dentatura esterna 239x180x4 mm 28 denti
655C - 805C	Art. 15178  OEM 568400 - 5104903 - 5161597 Anello per frizione di sterzo - dentatura esterna 271x201x5 mm 89 denti	Art. 15766  OEM 547395 Controdisco 260x190x2,5 mm 65 denti	
855C - 955C - 85.55 - 95.55 100.55	Art. 15269  OEM 5107223 - 5161598 Anello per frizione di sterzo - dentatura esterna 283,3x216x5 mm 93 denti	Art. 15765  OEM 5107259 Controdisco 271x205x2,5 mm 70 denti	Art. 16251  OEM 5180285 Anello di sterzo sinterizzato 283,3x216x5 mm 93 denti

(segue FIAT CINGOLI)

segue FIAT CINGOLI

55.65 FRUTTETO - 55.65 VIGNETO - 55.65 MONTAGNA - 60.65 VIGNETO - 60.65 FRUTTETO - 60.65 MONTAGNA - 70.65 - 70.65 MONTAGNA - 80.65		Art. 15317 OEM 5122253 5127787 - 5163798 Anello per frizione centrale - dentatura esterna 273x166x7 mm - 45 denti		Art. 15176 OEM 5109937 5109934-5161615 Anello per frizione di sterzo - in tessuto - dentatura esterna 239x180x4,8 mm - 28 denti		Art. 15582 OEM 5112063 - 5169148 Anello per frizione cambio 116x73x4,5 mm - 4 fori
				Art. 15389 OEM 566519 Anello per frizione di sterzo - dentatura interna 229x171x2 mm - 21 denti		Art. 15583 OEM 5121348 Anello per disco PTO 280x165x3,5 mm 24 fori
		Art. 15972 OEM 1424135M94 Disco PTO rigido in ferodo 280x165x3 mm 25x22EV - Z.10		Art. 15642 OEM 5145037 Disco PTO rigido in ferodo 280x165x3,5 mm 25x22EV - Z.10		Art. 15668 OEM 5109934 - 5109937 5161615 Anello per frizione di sterzo - sinterizzato - dentatura esterna 239x180x4 mm 28 denti
55.75 FRUTTETO - 55.75 VIGNETO - 55.75 MONTAGNA - 60.75 VIGNETO - 60.75 FRUTTETO - 60.75 MONTAGNA - 70.75 - 70.75 MONTAGNA - 80.75		Art. 15176 OEM 5109934 5109937 - 5161615 Anello per frizione di sterzo - in tessuto - dentatura esterna 239x180x4,8 mm 28 denti			Art. 15389 OEM 566519 Anello per frizione di sterzo - dentatura interna 229x171x2 mm - 21 denti	
				Art. 15668 OEM 5109934 - 5109937 - 5161615 Anello per frizione di sterzo - sinterizzato - dentatura esterna 239x180x4 mm - 28 denti		Art. 15582 OEM 5112063 - 5169148 Anello per frizione cambio 116x73x4,5 mm - 4 fori

FIAT ALLIS

7C - 7D (Mod. 01-02-03) 9 (Mod. 01-02-03) FA 100		Art. 15171 OEM 568399 Anello per frizione di sterzo - dentatura esterna - 309x214x5,4 101 denti				
4 - FL4 - FL4C		Art. 15173 OEM 588433 Anello per frizione centrale - dentatura esterna - 277x156x10 (1/3T) 45 denti		Art. 15177 OEM 569511 Anello per frizione centrale - dentatura esterna 277x166x7 - 45 denti		Art. 15388 OEM 571707 Anello per frizione cambio 88x48x4,5 mm 8 fori
		Art. 15176 OEM 5109934 5109937 - 5161615 Anello per frizione di sterzo - in tessuto - dentatura esterna 239x180x4,8 - 28 denti				Art. 15389 OEM 566519 Anello per frizione di sterzo - dentatura interna 229x171x2 mm 21 denti
FL6 - 5 (Mod. 01-02-03-04)		Art. 15178 OEM 568400 5104903 - 5161597 Anello per frizione di sterzo - dentatura esterna 271x201x5 - 89 denti		Art. 15766 OEM 547395 Controdisco 260x190x2,5 mm 65 denti		
10 - 14 - AD DB 14 FA120 - 150 - 200 FD5 - 7 - 9 - 14 - 14E FL5 - 7 - 9 - 12 - 14 FP40 / PL40 MOD.8 - 160.55		Art. 15767 OEM 586578 597258-79077633 Anello per frizione di sterzo sinterizzato bagno olio 305x213x4,3 - 95 denti		Art. 15814 OEM 4984755 - 79079550 - 582301 Anello per frizione di sterzo 208x145x3,6 - 68 denti		













Frizioni e loro componenti

CLUTCHES - CLUTCH DISK - BEARING - COUPLING - LEVER - SET-REVISION

















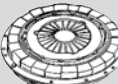



11

11

FORD

<p>5000 6600</p>	<p>Art. Kit 16216 new </p>		<p>OEM 82010859 - D8NN7580BB - C5NN7580A</p> <p>Kit frizione completo Ø 310 con disco in tessuto organico Ø 300 Z.25, cuscinetto avanzamento 15514 e cuscinetto volano 36,5x68x15</p>	
<p>5635 6635 7635</p>	<p>Art. Kit 16075 </p>		<p>OEM</p> <p>Kit composto da: - Meccanismo 15787 - Disco 15788</p>	
	<p>Art. 15787 </p>	<p>OEM 87575337 (ex5189823)</p> <p>Meccanismo Piatto Ø 310 mm</p>	<p>Art. 15788 </p> <p>OEM 5189825</p> <p>Disco di avanzamento cerametallico doppio segmento a 6 pale Ø 310 mm - 40x45 mm Z16</p>	<p>Art. 16009 </p> <p>OEM 5166287</p> <p>Manicotto con reggispinta</p>
	<p>Art. 16076 </p>	<p>OEM</p> <p>Damper Ø 136 mm 22x25 mm - Z10</p>		
<p>5640 6640 7740 7840 8240 8340</p>	<p>Art. Kit 16171 new </p>		<p>OEM 9973697</p> <p>Kit completo monodisco Ø 330 con disco sinterizzato a 8 pale Ø 330 Z.10 mozzo 38x45x7</p>	
<p>5000 6600 - 6700 7000 - 7600 - 7700 5610 - 6610 - 6710 - 7610 - 7710 - 7810 - 7910 8000 - 8210</p>	<p>Art. Kit 16232 new </p>		<p>OEM 83927137</p> <p>Kit frizione completo Ø 330 con disco in tessuto organico Ø 327 Z.10, cuscinetto avanzamento 15514 e cuscinetto volano.</p>	

FORT

MOTOCOLTIVATORI SERIE 180	Art. 15321 OEM  Frizione monodisco con molle a diaframma Piatto Ø 95 mm	Art. 15189 OEM  Disco frizione rigido 94x61x1,5 mm 15x12EV Z.8	Art. 15050 OEM  Cuscinetto reggispinta
	Art. 15588 OEM  Frizione monodisco con molle a diaframma Piatto Ø 90 mm	Art. 15525 OEM  Disco frizione rigido in ferodo 86x50x3,5 15x12EV Z.8	Art. 15763 OEM  Disco frizione rigido in ferodo 89x55x11 mm 15x12EV - Z.8 Ricambio per frizione 15588
MOTOCOLTIVATORE 108 - 202 con motore LOMBARDINI	Art. 15717 OEM  Frizione conica Ø 103x79 mm Albero Ø 23 mm Conicità 1:5 15x12 mm - Z.8		
MOTOCOLTIVATORE SERIE 180 CON MOTORE JLO	Art. 15590 OEM  Frizione monodisco con molle a diaframma Piatto Ø 90 mm	Art. 15525 OEM  Disco frizione rigido 86x50x1,8 mm 15x12EV - Z.8	Art. 15042 OEM  Manicotto con cuscinetto reggispinta
MOTOZAPPA 180 H	Art. 15840 OEM  Frizione Ø 103x124 mm a 4 dischi 12x15EV - Z.8 Albero Ø 25 mm	Art. 15630 OEM  Disco frizione sinterizzato Ø 93 mm	
MOTOZAPPA 180 MOTOCOLTIVATORE UNIVERSAL	Art. 15841 OEM  Frizione Ø 103x90 mm a 4 dischi 12x15EV - Z.8 Albero Ø 23 mm	Art. 15630 OEM  Disco frizione sinterizzato Ø 93 mm	
MOTOZAPPA 180 MOTOCOLTIVATORE UNIVERSAL vite lunga (dal 2000)	Art. 15842 OEM  Frizione Ø 103x90 mm a 4 dischi 12x15EV - Z.8 Albero Ø 23	Art. 15630 OEM  Disco frizione sinterizzato Ø 93 mm	
MOTOCOLTIVATORE 280 CD MOTOZAPPA MINITIGRE (motore benzina)	Art. 15835 OEM  Frizione Ø 103x79 mm a 3 dischi 12x15EV - Z.8 Albero Ø 23 mm	Art. 15630 OEM  Disco frizione sinterizzato Ø 93 mm	
MOTOCOLTIVATORE 280 CD MOTOZAPPA MINITIGRE (motore diesel)	Art. 15836 OEM  Frizione Ø 103x79 mm a 4 dischi 12x15EV - Z.8 Albero Ø 23 mm	Art. 15630 OEM  Disco frizione sinterizzato Ø 93 mm	
MOTOCOLTIVATORE 280 CD MOTOZAPPA (motore HONDA GX) (segue FORT)	Art. 15837 OEM  Frizione Ø 103x79 mm a 3 dischi 12x15EV - Z.8 Albero Ø 19,05 mm	Art. 15630 OEM  Disco frizione sinterizzato Ø 93 mm	























Frizioni e loro componenti

CLUTCHES - CLUTCH DISK - BEARING - COUPLING - LEVER - SET-REVISION







11

11



















segue FORT

MOTOCOLTIVATORE 280 CD MOTOZAPPA (motore HONDA GC)	Art. 15838 	OEM Frizione Ø 103x91 mm a 3 dischi 12x15EV - Z.8 Albero Ø 19,05 mm	Art. 15630 	OEM Disco frizione sinterizzato Ø 93 mm	
MOTOCOLTIVATORE 280	Art. 15839 	OEM Frizione Ø 103x113 mm a 4 dischi 12x15EV - Z.8 Albero Ø 25 mm	Art. 15630 	OEM Disco frizione sinterizzato Ø 93 mm	
MOTOCOLTIVATORE LEONE	Art. 15843 	OEM Frizione Ø 103x90 mm a 5 dischi 12x15EV - Z.8 Albero Ø 24 mm	Art. 15630 	OEM Disco frizione sinterizzato Ø 93 mm	
MOTOZAPPA - TIGROTTO - EL TIGRE	Art. 15318 	Frizione conica Ø 103x69 mm Albero Ø 22,5 mm Conicità 1:5 15x12EV - Z.8	Art. 15629 	OEM Manicotto con cuscinetto reggispinta	
MOTOZAPPA MOTOFALCIATRICE	Art. 15002 	OEM Frizione monodisco con molle a diaframma Piatto Ø 110 mm	Art. 15019 	OEM Disco frizione rigido 110x58x1,5 mm 15x12EV - Z.8	Art. 15057 OEM  Leva a forcella
	Art. 15050 	OEM Cuscinetto reggispinta	Art. 15042 	OEM Manicotto con cuscinetto reggispinta	
MOTOCOLTIVATORI TIGROTTO	Art. 15339 	Frizione bidisco completa di disco centrale Piatto Ø 110 mm	Art. 15019 	OEM Disco frizione rigido 110x58x1,5 mm 15x12EV - Z.8	Art. 15057 OEM  Leva a forcella
	Art. 15050 	OEM Cuscinetto reggispinta	Art. 15042 	OEM Manicotto con cuscinetto reggispinta	
CENTAURO	Art. 15004 	OEM Frizione monodisco a molle elicoidali Piatto Ø 160 mm	Art. 15025 	OEM Disco frizione rigido 160x110x4,3 mm 19x15,5x3 mm - Z.10	Art. 15059 OEM  Leva a forcella
	Art. 15051 	OEM Cuscinetto reggispinta	Art. 15048 	OEM Manicotto	









FOTON

6000 - 700 - 704 - FT 504 / 604 / 650 / 654 / 700 / 704 / 750A / 750B / 754A / 754B / 804 / 820 / 824 - JM 654 / 754 - ND 824 - TD 750 / 800 / 804 / 824	Art. Kit 15929 	 	OEM Kit frizione doppia a 6 leve con disco interno e disco PTO Ø 280 mm
TD 1004 / 854 / 900 / 904 / 920 - TF1054 - 1154	Art. Kit 15932 	 	OEM Kit frizione doppia a 6 leve con disco interno e disco PTO Ø 310 mm

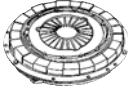
F & M MATRAS (FRANCESCHINI & MASINA)

MOTOZAPPA (160 cc)	Art. 15618 OEM  Frizione Ø 110 mm a dischi multipli con 4 dischi ed ingranaggio	Art. 15599 OEM  Frizione Ø 110 mm a dischi multipli con 4 dischi e senza ingranaggio	Art. 15600 OEM  Serie dischi completa composta da 4 dischi 104x78x3 mm
MOTOZAPPA R5 MOTOCOLTIVATORE 820	Art. 15601 OEM  Frizione monodisco con molle a diaframma Piatto Ø 90 mm	Art. 15602 OEM  Disco frizione rigido 86x50x3,5 mm 17x14EV - Z.9	Art. 15603 OEM  Disco frizione rigido 94x60x3 mm 17x14EV - Z.9
MOTOZAPPA R5 CON MOTORE JLO	Art. 15619 OEM  Frizione monodisco con molle a diaframma Piatto Ø 90 mm	Art. 15602 OEM  Disco frizione rigido 86x50x3,5 mm 17x14EV - Z.9	Art. 15758 OEM  Manicotto con cuscinetto reggispinta
MOTOZAPPA	Art. 15591 OEM  Frizione conica Ø 103x85 mm Albero Ø 22,5 mm Conicità 1:5 17x14EV - Z.9		
MOTOZAPPA R 100	Art. 15002 OEM  Frizione monodisco con molle a diaframma Piatto Ø 110 mm	Art. 15019 OEM  Disco frizione rigido 110x58x1,5 mm 15x12EV - Z.8	Art. 15042 OEM  Manicotto con cuscinetto reggispinta
MOTOZAPPA L 300	Art. 15627 OEM  Frizione monodisco con molle elicoidali Piatto Ø 160 mm	Art. 15040 OEM  Disco frizione rigido in ferodo 160x110x3,2 mm 22x19x3,5 mm - Z.10	
MOTOZAPPA R5	Art. 15670 OEM  Frizione conica Ø 104 mm - H 68 mm Albero Ø 22,5 mm Conicità 1:5 17x14EV - Z.9	Art. 15757 OEM  Disco frizione rigido 94x61x1,5 mm 17x14 mm - Z.9	Art. 15758 OEM  Manicotto con cuscinetto reggispinta

GOLDONI

SERIE 100 - 600 - Super 600 JOLLY - MONDIAL - UNO - FC (intercambiabile con 00005970)	Art. 15844 OEM 00005970  Frizione Ø 103x62 mm a dischi multipli con 3 dischi 12x15EV - Z.8 Albero Ø 23 mm	Art. 63868 OEM 06200093  Cuscinetto	
MOTOCOLTIVATORI: JOLLY JUNIOR - JOLLY SUPER - JOLLY PROFESS. - TWIST - JOKER (dalla serie P in avanti)	Art. 15274 OEM 02020015  Frizione monodisco con molle a diaframma Piatto Ø 110 mm Fornito senza disco	Art. 15022 OEM 06300063  Disco frizione rigido Ø 110 mm sinterizzato 15x12EV - Z.8	Art. 15754 OEM 00017181  Manicotto con cuscinetto reggispinta
	Art. 16207 OEM 00059242  Manicotto con cuscinetto reggispinta		
MOTOCOLTIVATORI SPECIAL LUX (FINO ALLA SERIE G) (segue GOLDONI)	Art. 15592 OEM 02020016  Frizione bidisco con molle a diaframma Piatto Ø 110 mm (Fornito senza disco 15022)	Art. 15022 OEM 06300063  Disco frizione rigido Ø 110 mm sinterizzato 15x12EV - Z.8	Art. 15754 OEM 00017181  Manicotto con cuscinetto reggispinta































Frizioni e loro componenti

CLUTCHES - CLUTCH DISK - BEARING - COUPLING - LEVER - SET-REVISION

11





















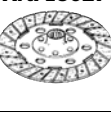













11

segue GOLDONI

MOTOCOLTIVATORI: SPECIAL - SUPER SPECIAL - SPECIAL LUX - (dalla serie H in avanti)	Art. 15004  Fornito senza disco	OEM 02020018 Frizione monodisco a molle elicoidali Piatto Ø 160 mm	Art. 15025  Fornito senza disco	OEM 00007474 06300116 Disco frizione rigido 160x110x4,3 mm 19x15,5x3 mm - Z.10	Art. 15059  Fornito senza disco	OEM 06300017 Leva a forcella	
	Art. 15051 	OEM 06300013 Cuscinetto reggispinta	Art. 15048 	OEM 06300011 Manicotto			
MOTOCOLTIVATORI: EXPORT - SERIE 500 - SERIE 700	Art. 15005  Fornito senza disco	OEM 02020020 Frizione monodisco a molle elicoidali Piatto Ø 187 mm	Art. 15026  Fornito senza disco	OEM 06300045 Disco frizione rigido 184x127x3,8 mm 19x15,5x3 mm - Z.10	Art. 15060 	OEM 00008313 Leva a forcella	
	Art. 15052 	OEM 06300023 Cuscinetto reggispinta 68x36x19 mm PER EXPORT 15051	Art. 15047 	OEM 06300022 Manicotto PER EXPORT 15048	Art. 16185 	OEM 00001757 Vite azionamento forcella frizione	
TRATTORINI: 926 - 933 RS/DT - 224 - 226 - 228 - 230 - 233 - 518T - 520T - 521T - MOTOAGRICOLE: SERIE 500 - 500 RT - 400 - 500T - 800 - 900 BASE 20 EURO TRANSCAR - TRANSPORTER UNIVERSAL UNIVERSALCAR	Art. 15008  Fornito senza disco	OEM 02020021 Frizione monodisco a molle elicoidali Piatto Ø 187 mm	Art. 15026  Fornito senza disco	OEM 06300045 Disco frizione rigido 184x127x3,8 mm 19x15,5x3 mm - Z.10 Non applicabile ai mod. 926 - 933 RS/DT	Art. 15060 	OEM 00008313 Leva a forcella	
	Art. 15141 	OEM 06300048 Disco frizione rigido 184x127x3,8 mm 22x18x3,5 mm - Z.10 Solo per mod. 926 - 933 RS/DT	Art. 16003 	OEM 06300075 Disco frizione rigido con molle 184x127x3,8 mm 22x18x3,5 mm - Z.10 Solo per mod. 926 - 933 RS/DT	Art. 15052 	OEM 06300023 Cuscinetto reggispinta 68x36x19 mm	
	Art. 15047 	OEM 06300022 Manicotto	Art. 16185 	OEM 00001757 Vite azionamento forcella frizione			
TRATTORINI: 236 - 238 - 240 - 1038 - 800 - 834 - 900 - 945 RS/DT - 1000 - 1045 R MOTOAGRICOLE: TRANSCAR TRANSPORTER EURO UNIVERSAL	Art. 15009  Fornito senza disco	OEM 02020022 Frizione monodisco a molle elicoidali Piatto Ø 215 mm	Art. 15027  Fornito senza disco	OEM 06300038 Disco frizione rigido 216x152x3,5 mm 22x18x3,3 mm - Z.10	Art. 15060 	OEM 00008313 Leva a forcella	
	Art. 15052 	OEM 06300023 Cuscinetto reggispinta 68x36x19 mm	Art. 15047 	OEM 06300022 Manicotto	Art. 16185 	OEM 00001757 Vite azionamento forcella frizione	
IDEA	Art. 15720  Fornito senza disco	OEM 02020035 Meccanismo a 3 leve completo di disco centrale in ferodo. Piatto Ø 180 mm	Art. 15721  Fornito senza disco	OEM 06300087 Disco frizione rigido centrale 180x127x3,8 mm 35x31 mm - Z.18	Art. 15272 	OEM 06300080 Cuscinetto reggispinta piccolo 82x50x28	
			Art. 15707 	OEM 06300086 Disco PTO in ferodo 180x127x3,8 mm 20x17 mm - Z.12	Art. 15808 	OEM 06300081 Cuscinetto reggispinta grande 117x75x27	

(segue GOLDONI)

segue GOLDONI

TRATTRICE MAXTER TRANSCAR TRANSCAR 80MR CLUSTER	 Art. 15724	OEM 02020046 Frizione monodisco a molle elicoidali Piatto Ø 280 mm	 Art. 15725	OEM 06300118 - 06300105 Disco frizione con molle 280x162x3,5 mm 35x31 mm - Z.18 Per CLUSTER - MAXTER	 Art. 16161	OEM 06300108 - 06300119 Disco frizione 280x172x3,8 mm 27x30 mm - Z.16 Per TRANSCAR 70/80MR
	 Art. 16197	OEM 02020041 Frizione a diaframma Ø 230 mm Per MAXTER 60	 Art. 16048	OEM 06300093 Disco frizione rigido 230x155x3,3 mm 28x32 - Z.17 Per MAXTER 60	 Art. 15980	OEM 06300088 - 06300117 Cuscinetto reggispinta 50x82x22 mm
	 Art. 16248	OEM 02020043 Frizione a diaframma Ø 280 mm Per MAXTER 70	 Art. 16249	OEM 06300099 Disco frizione Ø 280 mm 35x31 - Z.18 Per MAXTER 70	 Art. 62597	OEM 06200249 Cuscinetto PDF 45x75x16 mm Art. FAG 63883
TRATTORI: SERIE 1050 - SERIE 1055 MOTOAGRICOLE: TRANSCAR 55 CINGOLO EURO	 Art. 15010	OEM 02020023 Frizione monodisco a molle elicoidali Piatto Ø 215 mm Fornito senza disco	 Art. 15027	OEM 06300038 Disco frizione rigido 216x152x3,5 mm 22x18x3,5 mm - Z.10	 Art. 15060	OEM 00008313 Leva a forcella
	 Art. 15052	OEM 06300023 Cuscinetto reggispinta 68x36x19 mm	 Art. 15047	OEM 06300022 Manicotto		
TRANSCAR 60	 Art. 15010	OEM 02020023 Frizione monodisco a molle elicoidali Piatto Ø 215 mm Fornito senza disco	 Art. 16005	OEM 06300072 Disco PTO con parastrappi Ø 215 mm - 22x18 - Z.10	 Art. 15052	OEM 06300023 Cuscinetto reggispinta 68x36x19 mm
	 Art. 15047	OEM 06300022 Manicotto				
QUASAR 70/85/90 STAR 65/75/85/100 QUADRIFOGLIO STAR 4000 QUAD.	 Art. 15991	OEM 00037256 Meccanismo a 6 leve Ø 280 mm 36x40 mm - Z.20 + disco PTO (15988)	 Art. 15988	OEM 06300103 - 06300121 Disco PTO rigido Ø 280 mm 22x25 mm - Z.14	 Art. 15989	OEM 06300102 Disco Frizione lato cambio, ammortizzato Ø 280 mm 36x40 mm - Z.20
			 Art. 15755	OEM 06200155 Cuscinetto reggispinta 96,5x65x23,5 mm		 Art. 15756
3045 - 3050 - 3445 - 3450 STAR 3050 / 3070/V Serie COMPACT: 662 - 664 - 662D - 664D - 652D - 654D - 602D - 604D - 612D - 614D - 452 - 454 - 602 - 604 - 652 - 654	 Art. 15992	OEM 00035387 00035385 Meccanismo a 6 leve Ø 225 mm 31x35 mm - Z.18 + disco PTO (15993)	 Art. 15993	OEM 06300082 Disco PTO Ø 225 mm 20x23 mm - Z.20 Per frizione LUK	 Art. 15755	OEM 06200155 Cuscinetto reggispinta 96,5x65x23,5 mm
			 Art. 16004	OEM 06300097 Disco frizione organico cambio con molle Ø 225 mm 35x31 mm - Z.18 Per frizione LUK		 Art. 15756
ASTER RONIN ARBOS MR3040 MR3050	 Art. 16162	OEM 02020048 - 02020049 Meccanismo + disco PDF 9"x9"	 Art. 16163	OEM 06300112 Disco frizione cambio 225x150x3,8 mm 31x35 mm - Z.16	 Art. 16164	OEM 06300127 - 06300111 Disco frizione PDF 225x150x3 mm 17x20 mm - Z.12
	 Art. 15980	OEM 06300088 - 06300117 - 06300109 - 06300124 Cuscinetto reggispinta	 Art. 16201	OEM 06300110 - 06300123 Cuscinetto reggispinta 128x80x31		 Art. 62558

(segue GOLDONI)





























Frizioni e loro componenti

CLUTCHES - CLUTCH DISK - BEARING - COUPLING - LEVER - SET-REVISION















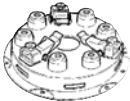



11

11





segue GOLDONI

3460 - 762 - 764 - 772 - 774 STAR 3070 STAR 3000V STAR 75 3000V STAR JO - 70	Art. 15994 	OEM 00035289 Meccanismo a 6 leve Ø 250 mm 35x31 mm - Z.18 + disco PTO	Art. 15995 	OEM 06300113 Disco PTO rigido organico Ø 250 mm 20x23 mm - Z.20	Art. 15996 	OEM 06300096 Disco Frizione lato cambio, ammortizzato a 18 molle - Ø 250 mm 35x31 mm - Z.18		
			Art. 15755 	OEM 06200155 Cuscinetto reggispinta 96,5x65x23,5 mm	Art. 15756 	OEM 06300056 Cuscinetto reggispinta PTO 106x139,5x25 mm		
STAR 3000V serie D-E QUASAR serie A-B STAR serie A-B	Art. 15997 	OEM 00035287 Meccanismo in ghisa a 6 leve Ø 280 mm + disco PTO (15998)	Art. 15998 	OEM 06300091 Disco PTO rigido organico Ø 280 mm 20x23 mm - Z.20	Art. 15999 	OEM 06300095 Disco cambio organico a molle Ø 280 mm 31x35 mm - Z.18		
			Art. 15755 	OEM 06200155 Cuscinetto reggispinta 96,5x65x23,5 mm	Art. 15756 	OEM 06300056 Cuscinetto reggispinta PTO 106x139,5x25 mm		
STAR 3000 STAR 3000 LE STAR 3060 STAR 3060 C ARBOS 4060F	Art. Kit 16000  	 OEM 00038911 00059896 - 00062806 Meccanismo doppio a 6 leve Ø 230 mm - 36x40 mm - Z.20 - + disco PTO (16001)						
			Art. 16176 	OEM 06300049 Disco PTO lato volano Ø 216 mm 23x20 mm - Z.20	Art. 16001 	OEM 06300107 06300122 Disco PTO lato volano Ø 225 mm 22x25 mm - Z.14	Art. 16002 	OEM 06300106 06300125 Disco lato cambio Ø 225 mm 36x40 mm - Z.20
					Art. 15755 	OEM 06200155 Cuscinetto reggispinta 96,5x65x23,5 mm	Art. 15756 	OEM 06300056 Cuscinetto reggispinta PTO 106x139,5x25 mm
STAR 3000 STAR 3000 LE STAR 3080 ENERGY 80 STAR 50-70 STAR QUADRIFOGLIO	Art. Kit 16006 	 OEM 00037254 - 00061035 Meccanismo doppio Frizione Ø 250/250 6 leve in ghisa + disco PTO (16007) Ø 250 mm - 40x36 mm - Z.20						
					Art. 16007 	OEM 06300101 - 06300120 Disco PTO rigido organico Ø 250 mm 25x22 mm - Z.14	Art. 16008 	OEM 06300100 Disco lato cambio organico a molle Ø 250 mm 40x36 mm - Z.20
					Art. 15755 	OEM 06200155 Cuscinetto reggispinta 96,5x65x23,5 mm	Art. 15756 	OEM 06300056 Cuscinetto reggispinta PTO 106x139,5x25 mm
Q 90/100/110 S 90/100/110 T4.100FB	Art. 16226 	OEM 00060568 Meccanismo doppio 11" Ø 280 mm completo di disco centrale 40x36 mm - Z. 20	Art. 16227 	OEM 06300114 Disco PTO a 5 pale 25x22 mm - Z.14				
			Art. 15755 	OEM 06200155 Cuscinetto reggispinta 96,5x65x23,5 mm	Art. 15756 	OEM 06300056 Cuscinetto reggispinta PTO 106x139,5x25 mm		

GOLDONI CINGOLATI

3.40 3.45 C45	Art. 15010  OEM 02020023 Frizione monodisco a molle elicoidali Piatto Ø 215 mm Fornito senza disco	Art. 15325  OEM 00660774 Disco frizione rigido 216x152x3,8 mm 26x21x4 mm - Z.10	Art. 16206  OEM 00660190 Anello frizione sterzo in tessuto 193+134+4,6 mm 63 denti
	Art. 63864  OEM 06200203 Cuscinetto		
3.60 C60	Art. 15350  OEM 00661173 Frizione monodisco a molle elicoidali Piatto Ø 280 mm	Art. 15169  OEM 00661174 Disco frizione rigido 279x171x4,3 mm 35x29x5,5 mm Z.10	Art. 15417  OEM 00660046 Anello frizione di sterzo in tessuto - dentatura esterna 219,2x152x4,7 mm 71 denti
	Art. 63868  OEM 06200093 Cuscinetto		
C55 C75 Lander 55-75	Art. 15997  OEM 00035287 Meccanismo in ghisa a 6 leve Ø 280 mm + disco PTO (15998)	Art. 15998  OEM 06300091 Disco PTO rigido organico Ø 280 mm 20x23 mm - Z.20	Art. 15999  OEM 06300095 Disco cambio organico a molle Ø 280 mm 31x35 mm - Z.18
		Art. 15755  OEM 06200155 Cuscinetto reggispinta 96,5x65x23,5 mm	Art. 15756  OEM 06300056 Cuscinetto reggispinta PTO 106x139,5x25 mm
	Art. 15994  OEM 00035289 Meccanismo a 6 leve Ø 250 mm 35x31 mm - Z.18 + disco PTO (15995)	Art. 15995  OEM 06300113 Disco PTO rigido organico Ø 250 mm 20x23 mm - Z.20	Art. 15996  OEM 06300096 Disco Frizione lato cambio, ammortizzato a 18 molle Ø 250 mm 35x31 mm - Z.18
		Art. 15755  OEM 06200155 Cuscinetto reggispinta 96,5x65x23,5 mm	Art. 15756  OEM 06300056 Cuscinetto reggispinta PTO 106x139,5x25 mm

HÜRLIMANN

H 355 - H355 F - H 360 - H 470	Art. 15722  OEM 008.5531.4 Meccanismo a 6 leve. Piatto Ø 280 mm (11")	Art. 15397  OEM 177.2250.3 144.2250.3 Disco centrale rigido in ferodo 280x165x3,5 mm 40x36EV - Z.20	Art. 15404  OEM Cuscinetto reggispinta 95x50x21,5 mm
		Art. 15121  OEM 008.4751.3 422.2222.3/20 Disco PTO rigido, in ferodo 280x165x3,5 mm 25x22EV - Z.14	
H 480		Art. 15392  OEM 195.2250.3 Disco centrale metalc. a 6 pale - rigido Ø 310 mm sinterizzato 40x36EV - Z.20	
(segue HÜRLIMANN)			































Frizioni e loro componenti

CLUTCHES - CLUTCH DISK - BEARING - COUPLING - LEVER - SET-REVISION













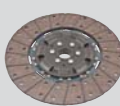





11

11







segue HÜRLIMANN

H 5160 - H 6160 -	Art. Kit 15394  	 Art. 15410 	OEM 212.2358.4/10 KIT meccanismo presa di movimento con disco	Art. 15293  OEM 212.2359.3/10 Disco centrale metalceramico a 7 pale Rigido Ø 350 mm sinterizzato 50x45EV - Z.24
	Art. 15445  OEM 269.2313.3 Disco presa di movimento rigido in ferodo 352x195x4,3 mm 50x45EV - Z.24	Art. 15883  OEM 2.2999.510.0 2.2999.207.0 2.2999.443.0 112x65x42 mm Cuscinetto reggispinta		
XB75 XB85-T-TB XB95-T-TB XT95 XT105 XT110	Art. Kit 16041  	 Art. 15924 	OEM 0.012.2621.4 Kit composto da: - Meccanismo 15923 - Disco centrale 15924 - Cuscinetto 15744	Art. 15744  OEM 2.2999.475.0 Cuscinetto reggispinta 90x55x22 mm
	Art. 15923  OEM 0.012.7094.3 Meccanismo frizione con molle a diaframma Ø 330 (13")	Art. 15917  OEM 0.011.9067.3 Disco Ø 280 mm 22x25 mm - 14 cave	Art. 15990  OEM 2.2999.153.0/10 Cuscinetto reggispinta cambio 90x50x22 mm	
H 361 XE 306 XE 355 - 365F	Art. 15916  OEM 0.012.2567.4 0.019.8634.4 Meccanismo a 6 leve completo di disco Ø 280 mm	Art. 15280  OEM 2.2999.153.0/10 Cuscinetto reggispinta cambio 90x50x22 mm		
	Art. Kit 16276  	OEM 0.017.7890.4 Kit Frizione con meccanismo a 6 leve disco e cuscinetti. Piatto Ø 310 mm.		
JOKER 75.4 - 80.4 XA 80 - 85 - 90 - 100 XE 80 - 90 - 100 XF80 - 80.4	Art. 15990  OEM Cuscinetto reggispinta cambio 90x50x22 mm	Art. 63363  OEM Cuscinetto PTO 100x65x18 mm	Art. 62549  OEM Cuscinetto volano 20x47x14 mm	
	Art. 15912  OEM 151.2222.3 0.015.6382.3 0.008.4803.3 Disco frizione rigido interno org. Ø 230 40x35 mm - Z.14	Art. 15913  OEM 151.2213.3 0.014.9429.3 0.008.4804.3 Disco lato cambio esterno Ø 250 25x20x4 mm - Z.10		
M 490	Art. Kit 16107  	 Art. 15963 	OEM 0.015.6389.4 0.176.2351.4/10 KIT meccanismo con disco Ø 330 mm	
H488 H488T PRESTIGE	Art. 15746  OEM 0.015.9285.3 0.008.4254.3/10 Meccanismo con molla a diaframma piatto Ø 310 mm	Art. 15441  OEM 44623.303 0.455.2330.3/10 0.015.9288.3 009.6924.3 /20 /30 Disco centrale in ferodo con molle parastrappi 310x191x3,5 mm 40x36,5 mm - Z.24		
	Art. 15744  OEM 2.2999.475.0 Cuscinetto reggispinta cambio 90x55x22 mm			
(segue HÜRLIMANN)				

segue HÜRLIMANN

H 476 - 476.4 H 478 - 478.4 - 478 T Prestige H 486 H 488 H 488 T Prestige XT 909 XT 910.6	Art. 15647  LUK	OEM 0.008.4184.3 3713531M1 0.014.9423.3/10 Meccanismo con molle a diaframma Piatto Ø 330 mm	Art. 15964  LUK	OEM Disco centrale in ferodo con molle parastrappi 330x196x4,2 mm 41x36,5EV - Z.24	Art. 15803  LUK	OEM Disco centrale in ferodo con molle parastrappi 330x196x4,2 mm 41x36,5EV - Z.24
	Art. 15895  LUK	OEM 007.7928.3 Disco centrale metaceramico 6 pale con parastrappi Ø310 mm sinterizzato 41x36,5 mm - Z.24	Art. 15965  LUK	OEM 0.014.9432.3 Disco centrale metalceramico a 6 p. con molle parastrappi Ø 330 mm sinterizzato 41x45,3 mm - Z.21	Art. 15749  Per gli altri modelli	OEM 0.014.9432.3 Disco centrale metalceramico a 6 p. con molle parastrappi Ø 330 mm sinterizzato 41x45,3 mm - Z.21
			Art. 15984  LUK	OEM 0.016.6105.3 Disco centrale metalceramico a 6 pale con molle parastrappi Ø 330 mm sinterizzato 41x36,5EV - Z.24	Art. 15673  LUK	OEM 009.6533.3 Disco centrale metalceramico a 6 pale con molle parastrappi Ø 330 mm sinterizzato 41x36,5EV - Z.24
			Art. 15883  LUK	OEM 2.2999.510.0 2.2999.207.0 2.2999.443.0 112x65x42 mm Cuscinetto reggispinta	Art. 15744  LUK	OEM 2.2999.475.0 Cuscinetto reggispinta 90x55x22 mm
M478.4 PRESTIGE 478/488T XB ELITE 6115 XT 908/909/910.4/ 910.6/911	Art. 15954  LUK	OEM 0.010.6912.3/10 0.015.6386.3 Meccanismo con molle a diaframma Piatto Ø 350 mm	Art. 15953  LUK	OEM 0.007.7929.3/10 0.015.6328.3 Disco Ø 350 mm 36,5x41 mm - Z.24	Art. 15983  LUK	OEM 0.007.7930.3/10 Disco Ø 350 mm 41x45 mm - Z.21
			Art. 16010  LUK	OEM 0.015.6381.3 Disco Ø 330 mm 36,5x41 mm - Z.24	Art. 15744  LUK	OEM 2.2999.475.0 Cuscinetto reggispinta 90x55x22 mm
PRINCE 30 - 35 - 35 TIER3 - 40 - 45 - 45 TIER3 - 50 - 55 - 55 TIER3	Art. Kit 15987  LUK		Art. 15987  LUK	OEM 0.012.5851.4/20 Kit frizione doppia a 6 leve con disco interno Ø 230 mm		
			Art. 62952  Art. FAG 63897	OEM Cuscinetto reggispinta PTO 75x115x20 mm	Art. 62577  Art. FAG 63863	OEM Cuscinetto volano 15x35x11 mm

IMER







MOTOZAPPA SERIE 115	Art. 15002  LUK	Meccanismo monodisco a molle elicoidali Piatto Ø 110 mm	Art. 15019  LUK	Disco frizione rigido in ferodo 110x58x1,5 mm 15x12EV - Z.8	Art. 15042  LUK	Manicotto con cuscinetto reggispinta
MOTOZAPPA SERIE 270	Art. 15296  LUK	OEM Meccanismo monodisco a molle elicoidali Piatto Ø 184 mm	Art. 15628  LUK	OEM Disco frizione con molle parastrappi 184x127x8 mm 22x19EV - Z.13	Art. 15052  LUK	OEM Cuscinetto reggispinta 68x36x19 mm
					Art. 15047  LUK	OEM Manicotto

Frizioni e loro componenti















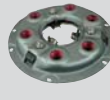





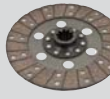

CLUTCHES - CLUTCH DISK - BEARING - COUPLING - LEVER - SET-REVISION

11

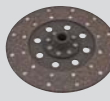













































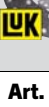

IMT

539	Art. Kit 16169  		OEM 962193M94 Kit composto da: - Meccanismo 15901 - Disco PTO 15183	Art. 15514 OEM  Cuscinetto reggispinta
	Art. 15901 OEM 3620401M91 Meccanismo 	Art. 15127 OEM 899823M91 1753753M92 - 3620411M91 Disco PTO rigido in ferodo 225x145x3,5 mm 44x38x7 mm -Z.10 	Art. 15183 OEM 890302M91 3620410M91 Disco frizione centrale rigido in ferodo 273x178x3,5 mm 29x23x4 mm -Z.10 	

ITMA

4RM SIRIO - G 215 AC2	Art. 15010 OEM 00661238 Meccanismo monodisco a molle elicoidali Piatto Ø 217 mm 	Art. 15027 OEM 00651814 Disco frizione rigido 216x152x3,5 mm 22x18 mm - Z.10 	Art. 15052 OEM 00651815  Cuscinetto reggispinta 68x36x19 mm
NIKE 180 - 280 - 300 - 301 - 302 - 322 - F215	Art. 15009 OEM 00651375 Frizione monodisco a molle elicoidali Piatto Ø 215 mm 	Art. 15347 OEM 00650990 Disco frizione rigido 215x154x4 mm 31x27EV - Z.11 	Art. 15055 OEM 00660775  Cuscinetto reggispinta
A35 - 30FL - 235 - A302 - A322 - F215.4	Art. 15009 OEM 00651375 Frizione monodisco a molle elicoidali Piatto Ø 215 mm 	Art. 15325 OEM 00660774 Disco frizione rigido 216x152x3,8 mm 26x21x4 mm - Z.10 	Art. 15055 OEM 00660775  Cuscinetto reggispinta
NIKE 250 - 320 - 350 - 351 - 401 - L250	Art. 15345 OEM 00660545 49624 Frizione monodisco a molle elicoidali Piatto Ø 250 mm 	Art. 15348 OEM 00651122 Disco frizione rigido 250x157x4,3 mm 35x30EV - Z.12 	
352 - 453 - 500 - 503 - L250	Art. 15345 OEM 00660545 49624 Frizione monodisco a molle elicoidali Piatto Ø 250 mm 	Art. 15234 OEM 00660544 Disco frizione rigido 250x155x4,3 mm 35x29x5,5 mm Z.10 	Art. 15980 OEM 06300117 - 06300073 - 12002  Cuscinetto reggispinta
A553 - A654 - H280.4 - 600 - 700 - (Frizione monodisco)	Art. 15350 OEM 00661173 Frizione monodisco a molle elicoidali Piatto Ø 280 mm 	Art. 15169 OEM 00661174 Disco frizione rigido 279x171x4,3 mm 35x29x5,5 mm Z.10 	
600 - 700 Frizione doppia	Art. 15147 OEM 00652253 Disco centrale rigido in ferodo 280x165x3,5 mm 40x35EV - Z.14 	Art. 15972 OEM 00652252 Disco PTO rigido in ferodo 280x165x3,5 mm 25x22EV - Z.10 	Art. 15642 OEM 00652252 Disco PTO rigido in ferodo 280x165x3,5 mm 25x22EV - Z.10 
3.55 - 3.65	Art. 15147 Disco centrale con molle parastrappi in ferodo 280x165x3,8 mm 40x35EV - Z.14 	Art. 15351 OEM 00652264 Disco PTO rigido in ferodo 280x165x3,5 mm 22x19EV - Z.10 	Art. 62951 OEM 06200222 Cuscinetto reggispinta PTO 70x110x20 mm  Art. FAG 63896
3.75 H - 3.85 TURBO	Art. 15352 OEM Disco centrale rigido metalceramico Ø 310 mm sinterizzato 40x36EV - Z.20 	Art. 15353 OEM 00652256 Disco presa di fresa rigido in ferodo 310x175x3,5 mm 25x22EV - Z.14 	

JOHN DEERE

840-940-1020-1040-1140-1530-1630	Art. Kit 16192     	OEM Kit composto da: - Meccanismo 15884 - Disco PTO 15885 - Cuscinetti 15744 - 63863				
	Art. Kit 16193     	OEM Kit composto da: - Meccanismo 15884 - Disco PTO 16012 - Cuscinetti 15936 - 63863				
	Art. 15884  	OEM AL120023 AL39618 Meccanismo monodisco Z.23 Ø 280 mm	Art. 15885  	OEM AL120017 AL67525 Disco PTO Ø 280 22x26 mm - Z.15	Art. 15744 	OEM Cuscinetto reggispinta cambio 55x90x20 mm
	Art. 15936  	OEM Cuscinetto 58x96x57 mm	Art. 16012  	OEM AL120018 Disco con molle parastrappi Ø 280 mm - Z.15	Art. 62577  Art. FAG 63863	OEM Cuscinetto VOLANO 15x35x11 mm
2040 - 2140 - 2650 - 2850 - 3040 - 3050 - 3140 - 3350 - 3640 - 3650	Art. 15571  	OEM AL68485 Frizione in ghisa con PTO fissa - volano a tazza - piattello reggispinta Piatto Ø 330 mm Z.27	Art. 15573  	OEM AL68022 AL61754 Disco avanzamento metalceramico a 5 pale con molle parastrappi Ø 327 mm - Z.10	Art. 15896  	OEM AL70272 Disco avanzamento metalceramico a 6 pale Ø 330 mm - Z.10
	Art. 15572  	OEM AL33126 Disco centrale in ferodo con molle parastrappi Ø 320 mm - Z.10	Art. 15936  	OEM Cuscinetto 58x96x57 mm	Art. 62577  Art. FAG 63863	OEM Cuscinetto volano 15x35x11 mm
	 Art. 16150 	OEM AL120029 Reggispinta idraulico	Art. 15744 	OEM CE13883 Cuscinetto reggispinta 55x90x22 mm		
820-830-840 - 920-930-940-V- 1030-1030VU-1035- 1040-V - 1130-1140- F-1350 1530-1550-1630-VU- 1635-EF-EV - 1640-F-1750-V-1840- F-1850-F-N-V 1950-N-2020-2030- 3040-2120-2150- 2155 - 2250-F-2350- 2450-F	Art. Kit 15935   	OEM Kit Frizione con meccanismo doppio e disco frizione				
	Art. 15885  	OEM AL120017 AL67525 Disco PTO Ø 280 mm 22x26 mm - Z.15	Art. 15744 	OEM Cuscinetto reggispinta cambio 55x90x20 mm	Art. 62577  Art. FAG 63863	OEM Cuscinetto VOLANO 15x35x11 mm
2130 - 3030	Art. 15886  	OEM AL120024 AL23095 Meccanismo monodisco Z.23 Ø 320 mm	Art. 15887  	OEM AL120016 AL30451 Disco PTO Ø 300 mm 22x26 mm - Z.15		
	Art. 15888  	OEM AL120025 AL28039 Meccanismo monodisco Z.27 Ø 320 mm	Art. 15889  	OEM AL120015 AL30452 Disco PTO Ø 300 mm 26x32 mm - Z.10		

(segue JOHN DEERE)



























Frizioni e loro componenti

CLUTCHES - CLUTCH DISK - BEARING - COUPLING - LEVER - SET-REVISION



























11

11

segue JOHN DEERE

1640 - 2040 - 2140 - 2240	Art. Kit 16194 				 OEM Kit composto da: - Meccanismo 15890 - Disco PTO 15893 - Cuscinetti 15936 - 63863
	Art. 15890 	OEM AL120026 AL39592 Meccanismo monodisco Z.23 Ø 320 mm	Art. 15893 	OEM AL120011 AL64340 Disco PTO Ø 320 mm 22x26 mm - Z.15	Art. 15937  OEM AL120013 Disco PTO Ø 295 mm 22x26 mm - Z.15
	Art. 16150 	OEM AL120029 Reggispinta idraulico	Art. 15936 	OEM Cuscinetto 58x96x57	Art. 62577  OEM Cuscinetto volano 15x35x11 mm Art. FAG 63863
2251/N - 2351 - 2651 - 2951 - 3640 - 3650	Art. 15897 	OEM AL68486 Meccanismo monodisco Ø 330 mm	Art. 15898 	OEM AL68023 Disco avanzamento metalceramico a 6 pale Ø 330 mm - Z.10	
5300/N - 5400/N - 5500/N (frizione OMG) (segue JOHN DEERE)	Art. 16057 	OEM ER135120 Meccanismo frizione compatto completo di disco centrale 34x40- Z.12 e disco PDF 22x19 - Z.13 Ø 280 mm	Art. 62597  Art. FAG 63883	OEM ER026007 - JD33004 Cuscinetto avanzamento 45x75x16 mm	Art. 63363  OEM ER027659 - AZ46129 Cuscinetto PTO 100x65x18 mm Art. FAG 63895
5300/N - 5400/N - 5500/N (modificati con frizioni OMG)	Art. Kit 15871 				 OEM ER135120 Kit Frizione con spingidisco, reggispinta frizione, cuscinetto guida frizione, kit bulloni e disco frizione
5300 - 5310 - 5400 - 5410 - 5500 - 5510 (segue JOHN DEERE)	Art. 15872 	OEM AL 120 117 Meccanismo frizione a 6 leve Ø 280 mm con disco a 6 pale 34x40 mm - Z.12	Art. 15873  Art. 62580  Art. FAG 63866	OEM AL 120 118 Disco avanzamento sint. Ø 280 mm 22x19 mm - Z.13 OEM Cuscinetto 17x40x12 mm	Art. 62597  OEM JD33004 Cuscinetto 45x75x16 mm Art. FAG 63883 Art. 15900  OEM AZ46129 Collare con cuscinetto

segue JOHN DEERE

5075GF/GN/GV - 5080G - 5090G/GF/GN/GV - 5100GF/GN - 5105GF/GN	Art. Kit 16254  		OEM ER426997 Kit Frizione 6 LEVE Ø 280 completo di meccanismo e disco PTO a 4 pale Z.13
	Art. 62597  Art. FAG 63883 OEM ER026007 - JD33004 Cuscinetto avanzamento 45x75x16 mm	Art. 63363  Art. FAG 63895 OEM ER027659 - AZ46129 Cuscinetto PTO 100x65x18 mm	Art. 62580  Art. FAG 63866 OEM JD9449 Cuscinetto volano 17x40x12 mm
5215-5215F-5215V 5315-5315F-5315V	Art. Kit 15955  		OEM Kit Frizione bidisco con meccanismo a 6 leve e disco PTO Ø 280 mm. 34x40 mm - Z.12
	Art. 15873  Art. FAG 63895 OEM AL120118 Disco frizione rigido sinterizzato a 4 pale mozzo 22x19 mm - Z.13	Art. 63363  Art. FAG 63895 OEM Cuscinetto PTO 100x65x18 mm	Art. 62580  Art. FAG 63866 OEM Cuscinetto 17x40x12 mm
5075GF/GN/GV - 5080G/GF/GV - 5085GF/GN/GV - 5090G/GF/GH/GV - 5100GF/GV - 5415 - 5515/F/HC/V - 5615/F/V	Art. Kit 15957  		OEM ER200707 Kit composto da: - Meccanismo - Disco frizione 15873 - Cuscinetto 63895
	Art. Kit 16105  		OEM ER199989 Kit composto da: - Meccanismo 15958 - Disco frizione 15873
	Art. 15958  Art. FAG 63895 OEM Frizione bidisco a 6 leve Ø 280 mm con disco a 6 pale 34x40 mm - Z.12	Art. 15873  Art. FAG 63895 OEM AL120118 Disco frizione rigido sinterizzato a 4 pale mozzo 22x19 mm - Z.13	Art. 63363  Art. FAG 63895 OEM Cuscinetto PTO 100x65x18 mm
			Art. 16253  Art. FAG 63895 OEM Cuscinetto reggispinta 75x45x16 mm
	Art. Kit 16258  		OEM ER434721 Kit composto da meccanismo Ø 310 e disco PTO a 4 pale Ø 280 Z.13 mozzo 22x19
5200 - 5300 - 5400/N - 5500/N - 5600 - 5700 - 5210 - 5310/N - 5410 - 5510/N - 5415/H - 5615/HC - 5715/H/HC	Art. 16121 (frizione OMG) 		OEM 351480 - RE66695 Kit Frizione a 6 leve Ø 280 completo di: disco AVANZAMENTO sinterizzato a 5 pale Ø 280 mm Z.19 - 32x35 disco PTO rigido Ø 280 mm Z.13 - 22x25

Frizioni e loro componenti

CLUTCHES - CLUTCH DISK - BEARING - COUPLING - LEVER - SET-REVISION

11

11

KUBOTA

Serie
M 4050 - 7050
4000ER 4850
5000ER 5030 - 5850
6000ER 6030
7000ER 7030 - 7500
8000ER 8030
M 4030/SU
M4500
M4950
M5500

**Art. Kit
16083**



OEM 3567225101

Kit composto da:
- Meccanismo 15878
- Disco 15879
- Cuscinetti 15990 - 63866

Art. 15878

OEM
35672 - 25101
Disco interno D.280
35x40 mm - Z.14



Art. 15879

OEM
35653 - 25143
Disco D.280
20x24 mm - Z.10



Art. 15280

OEM
Cuscinetto reggispinta
cambio 90x50x22 mm



Art. 15990

OEM
Cuscinetto reggispinta
cambio 90x50x22 mm



Art. 62580































OEM
Cuscinetto
17x40x12 mm



**Art. FAG
63866**



LAMBORGHINI RUOTE

R360 - R360 DT - R365 - R365 DT - R470 - R470 DT - R475 - R475 DT	Art. 15182  OEM 404 0044 1 Disco frizione centrale rigido in ferodo 295x170x3,85 mm 48x44EV - Z.23	Art. 15411  OEM 427 2450 3 Disco PTO rigido in ferodo 280 x165x3,5 mm 30x27EV - Z.16	
R483 - R483 DT CRONO 554-60	Art. Kit 16044      	OEM 0.012.2564.4 Kit composto da: - Meccanismo 15395 - Disco PTO 15804 - Cuscinetti 15990 - 63896 - 63836	
	Art. 15395  OEM 463.2411.4 0.012.2564.4 - Meccanismo a 6 leve completo di disco centrale in ferodo senza il disco PTO - Piatto Ø 250 mm (11")	Art. 15804  OEM 0.011.9063.3 Disco PTO rigido in ferodo 225x145x3,5 mm 25x22EV - Z.14	Art. 15990  OEM 2.2999.153.0/10 Cuscinetto reggispinta cambio 90x50x22 mm
	Art. 15402  OEM 254.2213.3 463.2413.3 - 0.012.2565.3 Disco centrale rigido in ferodo 250x155x3,5 mm 40x36EV - Z.20	Art. 15403  OEM 254.2222.3/10 463.2422.3 Disco PTO rigido in ferodo 250x155x3,5 mm 25x22EV - Z.14 Per vecchi modelli	Art. 15280  OEM 2.2999.153.0/10 Cuscinetto reggispinta cambio 90x50x22 mm
		Art. 62951  OEM 2.2021.018.0 Cuscinetto reggispinta PTO 70x110x20 mm Art. FAG 63896	Art. 62549  OEM Cuscinetto volano 20x47x14 mm Art. FAG 63836
R503 - R503 DT - R583 - R583 DT - R633 - R633 DT - R683 - R683 DT - R653 - R653 DT - R654 - R654 DT - R684 - R684 DT - R724 - R724 DT - R754 - R754 DT - R824 - R824 DT - R845 - R845 DT - R854 - R854 DT - 660 - 660DT	Art. Kit 15959      	OEM Kit composto da: - Meccanismo 15745 - Disco 15917 - Cuscinetti 15990 - 63896 - 63836	
	Art. 15745  OEM 0.012.2574.4 -0.012.2571.4 Meccanismo 6 leve completo di disco centrale sinterizzato 40x36 - Z.20 Piatto Ø 280 mm	Art. 15917  OEM 0.011.9067.3 Disco Ø 280 mm 22x25 mm - 14 cave	Art. 15119  OEM 171.2272.3 - 463.2413.3 - 171.2251.3 Disco centrale metalceramico rigido a 6 placchette Ø 280 mm sinterizzato 40x36EV - Z.20
	Art. 15397  OEM 422.2261.3 - 463.2413.3 Disco centrale rigido in ferodo 280x165x3,8 mm 40x36EV - Z.20	Art. 15280  OEM 2.2999.153/10 Cuscinetto reggispinta cambio 90x50x22 mm	Art. 62951  OEM 2.2021.018.0 Cuscinetto reggispinta PTO 70x110x20 mm Art. FAG 63896
	Art. 15990  OEM 2.2999.153.0/10 Cuscinetto reggispinta cambio 90x50x22 mm	Art. 15404  OEM 2.2099.008.0 Cuscinetto reggispinta 95x50x21,5 mm	Art. 62549  OEM Cuscinetto volano 20x47x14 mm Art. FAG 63836

(segue LAMBORGHINI
RUOTE)





























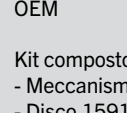

Frizioni e loro componenti

CLUTCHES - CLUTCH DISK - BEARING - COUPLING - LEVER - SET-REVISION





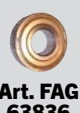



























11

11

segue LAMBORGHINI RUOTE

R704 - R704 DT R804 - R804 DT	Art. 15540  OEM 427.2410.4/10 - Meccanismo a 6 leve completo di disco centrale metalceramico a 6 pale - senza il disco PTO. - Piatto Ø 280 mm (11")	Art. 15541  OEM 427.2451.3 Disco centrale metalceramico rigido a 6 pale Ø 280 mm sinterizzato 48x44EV - Z.23	Art. 15121  OEM 422.2222.3/20 Disco PTO rigido in ferodo 280x165x3,5 mm 25x22EV - Z.14 N.B.: Solo per mod. R804 - R804DT
		Art. 15542  OEM 427.2450.3/10 Disco PTO rigido in ferodo 280x165x3,5 mm 30x27EV - Z.16	N.B.: Solo per mod. R704 - R704DT
R955 - R955DT		Art. 15392  OEM 195.2250.3 Disco centrale metalceramico rigido a 6 placchette Ø 310 mm sinterizzato 40x36EV - Z.20	
R1106 - R1106 DT - R1156 - R1156 DT - R1256 - R1256 DT - R1306 TURBO DT - R1506 TURBO DT - R1706 TURBO DT - 956-100	Art. Kit 15394  	 OEM 212.2358.4/10 KIT meccanismo presa di movimento con disco	Art. 15293  OEM 212.2359.3/10 Disco centrale metalceramico a 7 pale Rigido Ø 350 mm sinterizzato 50x45EV - Z.24
Originale VALEO	Art. 15445  OEM 269.2313.3 Disco presa di movimento rigido in ferodo 352x195x4,3 mm 50x45EV - Z.24	Art. 15410  OEM 250.6533.3 Manicotto con cuscinetto reggispinta	Art. 15883  OEM 2.2999.510.0 2.2999.207.0 2.2999.443.0 112x65x42 mm Cuscinetto reggispinta
FORMULA 105 AGILE 880S -990S CROSS 674-70N/ BASSO - GRAN PRIX 674-70 774-80 - 874-90T SPRINT 674-70 675-75 - 684-85	Art. 15420  OEM 0.014.9424.3 0.008.4293.3 0.008.4254.3/10 Meccanismo con molle a diaframma Piatto Ø 310 mm	Art. 15982  OEM 0.015.9289.3 0.014.111 1.3 Disco centrale metalceramico 6 pale Ø310 mm sinterizzato 41x36 mm - Z.24	Art. 15895  OEM 0.014.9433.3 Disco centrale metaceramico 6 pale con parastrappi Ø310 mm sinterizzato 41x36,5 mm - Z.24
		Art. 15748  OEM 0.015.9289.3 0.014.1111.3 Disco centrale metaceramico 6 pale con parastrappi Ø310 mm sinterizzato 40x36,5 mm - Z.24	Art. 15744  OEM 2.2999.475.0 Cuscinetto reggispinta cambio 90x55x22 mm
CRONO 564.60 574.70 - 554-55F GRIMPER 555-560 PLUS 880F-990F CRONO F70 TARGET	Art. Kit 15959      	OEM Kit composto da: - Meccanismo 15745 - Disco 15917 - Cuscinetti 15990 - 63836 - 63896	
	Art. 15745  OEM 0.012.2574.4 - 0.012.2571.4 Meccanismo 6 leve completo di disco centrale sinterizzato 40x36 - Z.20 Piatto Ø 280 mm	Art. 15917  OEM 0.011.9067.3 Disco Ø 280 mm 22x25 mm - 14 cave	Art. 62951  OEM 2.2021.018.0 Cuscinetto reggispinta PTO 70x110x20 mm
	Art. 15990  OEM 2.2999.153.0/10 Cuscinetto reggispinta cambio 90x50x22 mm	Art. 15280  OEM 2.2999.153/10 Cuscinetto reggispinta cambio 90x50x22 mm	Art. 62549  OEM Cuscinetto volano 20x47x14 mm
(segue LAMBORGHINI RUOTE)			Art. FAG 63836 

segue LAMBORGHINI RUOTE

AGILE 880S-990S CROSS 674-70N GRAN PRIX 674-70/774-80-874-90T	Art. 15746  LUK	OEM 0.015.9285.3 0.008.4254.3/10 Meccanismo con molla a diaframma piatto Ø 310 mm	Art. 15963  LUK	OEM 44623.303 0.455.2330.3/10 0.015.9288.3 009.6924.3 /20 /30 Disco centrale in ferodo con molle parastrappi 310x191x3,5 mm 40x36,5 mm - Z.24	Art. 15441  LUK	OEM 44623.303 0.455.2330.3/10 0.015.9288.3 009.6924.3 /20 /30 Disco centrale in ferodo con molle parastrappi 310x191x3,5 mm 40x36,5 mm - Z.24
	Art. 16011  LUK	OEM 0.015.6393.3 Disco centrale in ferodo Ø 310 mm - Z.24	Art. 15962  LUK	OEM 0.015.9289.3 0.014.1111.3 Disco centrale metaceramico 6 pale con parastrappi Ø 310 mm sinterizzato 41x36 mm - Z.24	Art. 15748  LUK	OEM 0.015.9289.3 0.014.1111.3 Disco centrale metaceramico 6 pale con parastrappi Ø 310 mm sinterizzato 40x36,5 mm - Z.24
					Art. 15744  LUK	OEM 2.2999.475.0 Cuscinetto reggispinta cambio 90x55x22 mm
AGILE 660S 770S CROSS 574-60N 674-70N/BASSO GRAN PRIX 674-70 SPRINT 654-55 664-60 664-65	Art. Kit 16038  LUK	 LUK	 LUK	 LUK	OEM 0.015.9287.3 Kit composto da: - Meccanismo 15439 - Disco centrale 15979 - Cuscinetto 15744	
	Art. 15439  LUK	OEM 0.015.9287.3 255.2320.3/10 0.009.6914.3/20 Meccanismo con molle a diaframma Piatto Ø 280 mm	Art. 15979  LUK	OEM 0.015.9286.3 Disco frizione centrale in ferodo con molle parastrappi 280x172x3,5 mm 40x36,5EV - Z.24	Art. 15440  LUK	OEM 0.015.9286.3 0.009.6913.3/10 255.2330.3/20 270.2330.3/10 Disco frizione centrale in ferodo con molle parastrappi 280x172x3,5 40x36,5EV - Z.24
				Art. 15744  LUK	OEM 2.2999.475.0 Cuscinetto reggispinta 90x55x22 mm	
FORMULA 135 PREMIUM 1300	Art. Kit 16042  LUK	 LUK	 LUK	 LUK	OEM Kit composto da: - Meccanismo 15881 - Disco PTO 15882 - Cuscinetto 15883	
	Art. Kit 16039  LUK	 LUK	 LUK	OEM Kit composto da: - Meccanismo 15881 - Disco PTO 15882		
	Art. 15881  LUK	OEM 008.5595.3 Meccanismo frizione Ø 350	Art. 15882  LUK	OEM 008.5596.3/10 Disco PTO Ø 350 mm - 41x45 mm Z.21	Art. 15883  LUK	OEM 2.2999.510.0 2.2999.207.0 2.2999.443.0 112x65x42 mm Cuscinetto reggispinta
RUNNER 250-350 Prima Serie	Art. 15706  LUK	OEM 0.010.0288.4 Meccanismo a 3 leve completo di disco centrale in ferodo senza il disco PTO Piatto Ø 184 mm	Art. 15707  LUK	OEM 0.008.7303.3/40 Disco PTO in ferodo 184x127x3,8 mm 20x17 mm Z.12	Art. 15272  LUK	OEM 0.010.8739.3 Cuscinetto reggispinta piccolo - 82x50x28
					Art. 15808  LUK	OEM 0.010.8738.3 Cuscinetto reggispinta grande - 117x75x27
RUNNER 250 - 350 Seconda Serie RUNNER 450	Art. 15704  LUK	OEM 0.009.6395.4/10 Meccanismo a 3 leve completo di disco centrale in ferodo senza il disco PTO Piatto Ø 215 mm	Art. 15705  LUK	OEM 0.009.6437.3 Disco PTO rigido in ferodo 216x152x3,8 mm 20x17 mm - Z.12	Art. 15272  LUK	OEM 0.010.8739.3 Cuscinetto reggispinta piccolo - 82x50x28
	(segue LAMBORGHINI RUOTE)				Art. 15808  LUK	OEM 0.010.8738.3 Cuscinetto reggispinta grande 117x75x27





























Frizioni e loro componenti

CLUTCHES - CLUTCH DISK - BEARING - COUPLING - LEVER - SET-REVISION



















11

11

segue LAMBORGHINI RUOTE

<p>R1.30 / 35 / 35 TIER3 / 40 / 45 / 45 TIER3 / 50 / 55 / 55 TIER3</p>	<p>Art. Kit 15987</p>    <p>OEM 0.012.5851.4/20 Kit frizione doppia a 6 leve con disco interno Ø 230 mm</p>	<p>Art. 62952 OEM Cuscinetto reggispinta PTO 75x115x20 mm</p>  <p>Art. FAG 63897</p>	<p>Art. 62577 OEM Cuscinetto volano 15x35x11 mm</p>  <p>Art. FAG 63863</p>
<p>FORMULA 105-115-135 GRAN PRIX 774-80 874-90T PREMIUM 850 950 1050 1060 1300 774 774.5 774.80 874 TURBO 874-90 GP</p>	<p>Art. 15647 OEM 0.008.4184.3 0.014.9423.3 Meccanismo con molle a diaframma Piatto Ø 330 mm</p>  <p>Art. 15895 OEM 007.7928.3 Disco centrale metalceramico 6 pale con parastrappi Ø310 mm sinterizzato 41x36,5 mm - Z.24 Per 774 - 774.5 - 774.80 - 874 TURBO - 874-90 GP</p> 	<p>Art. 15964 OEM 008.9937.3 Disco centrale in ferodo con molle parastrappi 330x196x4,2 mm 41x36,5EV - Z.24</p>  <p>Art. 15965 OEM 0.014.9432.3 Disco centrale metalceramico a 6 pale con molle parastrappi Ø330 mm sinterizzato 41x45,3 mm - Z.21 Per gli altri modelli</p> 	<p>Art. 15803 OEM 008.9937.3 Disco centrale in ferodo con molle parastrappi 330x196x4,2 mm 41x36,5EV - Z.24</p>  <p>Art. 15749 OEM 0.014.9432.3 Disco centrale metalceramico a 6 pale con molle parastrappi Ø330 mm sinterizzato 41x45,3 mm - Z.21 Per gli altri modelli</p> 
<p>573 573 60N 574 574 60N 674 674-70 AGILE 660 AGILE 770</p>	<p>Art. 15984 OEM 0.016.6105.3 Disco centrale metalceramico a 6 pale con molle parastrappi Ø 330 mm sinterizzato 41x36,5EV - Z.24</p> 	<p>Art. 15673 OEM 009.6533.3 Disco centrale metalceramico a 6 pale con molle parastrappi Ø 330 mm sinterizzato 41x36,5EV - Z.24</p> 	<p>Art. 15883 OEM 2.2999.510.0 2.2999.207.0 2.2999.443.0 112x65x42 mm Cuscinetto reggispinta</p>  <p>Art. 15744 OEM 2.2999.475.0 Cuscinetto reggispinta 90x55x22 mm</p> 
<p>R3.75 R3.85-T R3.95-T-TB C90-100 C95-105 TRIUMPH100</p>	<p>Art. Kit 16041</p>     <p>OEM 0.012.2621.4</p>	<p>Art. 15979 OEM 0.015.9286.3 Disco frizione centrale in ferodo con molle parastrappi 280x172x3,5 mm 40x36,5EV - Z.24</p> 	<p>Kit composto da: - Meccanismo 15923 - Disco centrale 15924 - Cuscinetto 15744</p> <p>Art. 15440 OEM 0.015.9286.3 0.009.6913.3/10 255.2330.3/20 270.2330.3/10 Disco frizione centrale in ferodo con molle parastrappi 280x172x3,5 mm 40x36,5EV - Z.24</p> 
<p>R3.75 R3.85-T R3.95-T-TB C90-100 C95-105 TRIUMPH100</p>	<p>Art. 15923 OEM 0.012.7094 Meccanismo frizione con molle a diaframma Ø 330 mm (13")</p> 	<p>Art. 15924 OEM 0.012.7095.3/10 Disco centrale a 5 pale 36,5x41 mm - Z.24</p> 	<p>Art. 15744 OEM 2.2999.475.0 Cuscinetto reggispinta 90x55x22 mm</p> 
<p>CRONO 564-60 - 554- 55 - 564-65F R 660</p>	<p>Art. 15916 OEM 0.012.2567.4 0.019.8634.4 Meccanismo a 6 leve completo di disco Ø 280 mm</p> 	<p>Art. 15917 OEM 0.011.9067.3 Disco Ø 280 mm 22x25 mm - 14 cave</p> 	<p>Art. 15990 OEM 2.2999.153.0/10 Cuscinetto reggispinta cambio 90x50x22 mm</p> 
			<p>Art. 15280 OEM 2.2999.153.0/10 Cuscinetto reggispinta cambio 90x50x22 mm</p> 

segue **LAMBORGHINI RUOTE**

345	Art. 15912  OEM 151.2222.3 0.015.6382.3 0.008.4803.3 Disco frizione rigido interno organico Ø 230 40x35 mm - Z.14	Art. 15913  OEM 151.2213.3 0.014.9429.3 0.008.4804.3 Disco lato cambio esterno Ø 250 mm 25x20x4 mm - Z.10	
FORMULA 115 - PREMIUM 850/950/1050/1100 - R774 80GP/80N R874 90GP	Art. 15954  OEM 0.010.6912.3/10 0.015.6386.3 Meccanismo con molle a diaframma Piatto Ø 350 mm	Art. 15953  OEM 0.007.7929.3/10 0.015.6328.3 Disco Ø 350 mm 36,5x41 mm - Z.24	Art. 15983  OEM 0.007.7930.3/10 Disco Ø 350 mm 41x45 mm - Z.21
		Art. 16010  OEM 0.015.6381.3 Disco Ø 330 mm 36,5x41 mm - Z.24	Art. 15744  OEM 2.2999.475.0 Cuscinetto reggispinta 90x55x22 mm
CF 100 L/N - 90 L/N/ST CROSS 75/80/674-75N NITRO R 90 R2.70/76/80/86/90 R2.76/86 TARGET R3.75 T/TB R3.80/85/90 R3 EVO 85/85TARGET R3.90 TREND RF 70/75/90/100/110 RS 70/75/90/100/110 RV 80/90/100/110 SPIRE 70/80/85/90/F80/F90/F100/F105/F115/S80/S90/S100/S105/S115/V80/V90/V100/V105/V115 STRIKE 80/90/CF90/CF100	new Art. Kit 16055  OEM Kit composto da: - Meccanismo 15960 - Disco 15961 - Cuscinetto 15744		
	Art. 15960  OEM 0.014.9017.3 Meccanismo frizione con molle a diaframma Ø 310 mm	Art. 15961  OEM 0.014.9016.3 0.015.2816.3 Disco Ø 310 mm	Art. 15744  OEM 2.2999.475.0 Cuscinetto reggispinta 90x55x22 mm
CRONO 65/70/75/ CROSS 65S/50R/55R /60R REKORD 60/70/60E/70E/65/75 TREND 65/70/75 SPIRE TREND 50/65/70/75/F70	new Art. Kit 16218  OEM 9.J1424.00.9 - 0.015.4708.3/10 Kit Frizione con meccanismo a 6 leve disco e cuscinetti. Piatto Ø 280 mm.		
CRONO 75/80/90/100 R2 TARGET R2 TREND REKORD 75.4/80.4 RF TREND 80/80.4 SPIRE F 80 SPIRE 85/90/90.4/100	new Art. Kit 16276  OEM 0.017.7890.4 Kit Frizione con meccanismo a 6 leve disco e cuscinetti. Piatto Ø 310 mm.		
	Art. 15990  OEM Cuscinetto reggispinta cambio 90x50x22 mm	Art. 63363  OEM Cuscinetto PTO 100x65x18 mm Art. FAG 63895	Art. 62549  OEM Cuscinetto volano 20x47x14 mm Art. FAG 63836
R5. 130 - 140 EVO - 150 - 160 EVO	new Art. Kit 16233  OEM 9.P023.00.9 Kit Frizione mono disco con cuscinetto reggispinta. Ø 350 mm.		
	Art. 16234  OEM 0.015.7949.3 0.015.7949.3/10 Disco frizione a 7 pale Ø 350 mm - Z.24	Art. 15883  OEM 2.2999.510.0 2.2999.207.0 2.2999.443.0 112x65x42 mm Cuscinetto reggispinta	





















Frizioni e loro componenti

CLUTCHES - CLUTCH DISK - BEARING - COUPLING - LEVER - SET-REVISION









11

11





















LAMBORGHINI CINGOLI

C230 - C340 - C352 - C362 -	Art. 15417  OEM 434.5714.0/10 Anello frizione di sterzo - dentatura esterna 219,2x152x4,7 mm 71 denti	Art. 15672  OEM 431.2313.3 Disco centrale rigido in ferodo-tessuto 225x145x3,5 mm 25,5x20,5x4 mm - Z.10 Per frizione singola	
C350 - C452	Art. 15180  OEM 400.2401.4 Disco frizione centrale rigido in ferodo tessuto 250x150x3,5 mm 45x41EV - Z.16	Art. 15355  OEM 400.2401.5 Disco PTO rigido in ferodo 250x150x3,5 mm 28x23x6 mm - Z.6	Art. 15181  OEM 0.400.1808.7 Disco PTO rigido in ferodo 250x150x3,5 mm 22x18x6 mm - Z.6
	Art. 15206  OEM 400.0515.4 Anello frizione di sterzo - dentatura esterna 219,2x152x6 mm 71 denti		
C482L - C503 - C553 - C583 - C663 - C664 - ERGOMATIC	Art. 15397  OEM 422.2261.3 Disco frizione centrale rigido in ferodo tessuto 280x165x3,8 mm 40x36EV - Z.20	Art. 15121  OEM 84751.3/10 - 422.2222.3/20 Disco PTO rigido in ferodo 280x165x3,5 mm 25x22EV - Z.14	Art. 15389  OEM 160.5715.0 Anello per frizione di sterzo - dentatura interna 229x171x2 mm 21 denti
	Art. 15176  OEM 160.5714.0/10 Anello per frizione di sterzo - in tessuto - dentatura esterna 239x180x4,8 - 28 denti		
C503 (2ª serie tutte le versioni) C553-C603 (tutte le versioni) C653 (2ª serie tutte le versioni) C754	Art. 15177  OEM160.2214.0 Anello per frizione centrale - dentatura esterna 277x166x7 - 45 denti		
-	Art. Kit 16055   	 	  OEM Kit composto da: - Meccanismo 15960 - Disco 15961 - Cuscinetto15744
	Art. 15960  OEM 0.014.9017.3 Meccanismo frizione con molle a diaframma Ø 310 mm	Art. 15961  OEM 0.014.9016.3 0.015.2816.3 Disco Ø 310 mm	Art. 15744  OEM 2.2999.475.0 Cuscinetto reggispinta 90x55x22 mm

LAMPACRESCIA - MGM

MOTOZAPPA MOTOCOLTIVATORE (motore benzina)	Art. 15845  OEM Frizione Ø 103x99 mm a 3 dischi 12x15EV - Z.8 Albero Ø 23 mm	Art. 15630  OEM Disco frizione sinterizzato Ø 93 mm	
MOTOZAPPA MOTOCOLTIVATORE (motore diesel)	Art. 15589  OEM Frizione Ø 103x99 mm a 4 dischi 15x12EV - Z.8 Albero Ø 23 mm	Art. 15630  OEM Disco frizione sinterizzato Ø 93 mm	
MOTOZAPPA MOTOCOLTIVATORE (motore HONDA)	Art. 15847  OEM Frizione Ø 103x128 mm a 4 dischi 12x15EV - Z.8 Albero Ø 19,05 mm	Art. 15630  OEM Disco frizione sinterizzato Ø 93 mm	
MOTOZAPPA MOTOCOLTIVATORE (motore HONDA)	Art. 15848  OEM Frizione Ø 103x139mm a 4 dischi 12x15EV - Z.8 Albero Ø 25,4 mm	Art. 15630  OEM Disco frizione sinterizzato Ø 93 mm	

LANDINI RUOTE

5500-5550-5830-6500 6880-6030-6830-5840 6040-6840-5860-6060 6860-6550. BLIZZARD 50-55-60-65. ATLAS 70-75. FRUTTETI 5530-6030- 6530-5560 6060-6560. ADVANTAGE 55-65. SERIE REX	Art. 15574  LUK	OEM 3303238M93 3303000M96 - 3540479M91 - Meccanismo a 6 leve completo di disco centrale molleggiato in ferodo - fornito senza disco PTO - Piatto Ø 280 mm (11")	Art. 15972  LUK e effler	OEM 1424135M94 Disco PTO rigido in ferodo 280x165x3 mm 25x22EV Z.10	Art. 15642  	OEM 1424135M93 Disco PTO rigido in ferodo 280x165x3 mm 25x22EV Z.10
	Art. 15147  	OEM 3311538M92 Disco centrale in ferodo con molle parastrappi 280x165x4,4 mm 40x35EV - Z.14	Art. 15990  LUK	OEM 1423473M94 Cuscinetto reggispinta cambio 90x50x22 mm	Art. 15280  	OEM 1423473M94 Cuscinetto reggispinta cambio 90x50x22 mm
	Art. 15404  	OEM 392051X1 Cuscinetto reggispinta 95x50x21,5 mm	Art. 15751  	OEM 1442381X1 Cuscinetto reggispinta PTO 65x100x11 mm	Art. 62583  	OEM 339599X1 - 3670612M1 Cuscinetto volano 20x47x14 mm Art. FAG 63869
ADVANTAGE 55F/FB/ GE/GT - 60F/FP/GE/GT/ GTP/L/LP/V - 75F/FP/GE/ GT/GTP/L/LP/V - 85F/FP/ GE/GT/GTP/L/LP/V BLIZZARD 75-85 REX 80F SERIE 254-274-284- 364-374-394 4530-4830-4830-5500- 5530-5550-5830-5840- 5860-6030-6040-6060- 6500-6530-6550-6560- 6830-6840-7500-7530- 7550-7830-7860-7870- 7880-8500-8530-8550- 8830-8860-8870	Art. Kit 16037  LUK	OEM			Kit composto da: - Meccanismo 15575 - Disco PTO 15972 - Cuscinetti 15990 - 15751 - 63869	
Art. Kit 15928  LUK	OEM 3532239M93 Kit composto da: - Meccanismo 15575 - Disco PTO 15972					
N.B.: VALEO e LUK sono intercambiabili fra di loro	Art. 15575  LUK	OEM 3304585M95 3540480M91 - Meccanismo a 6 leve completo di disco centrale metalceramico a 5 pale - fornito senza disco PTO - Piatto Ø280 mm (11")	Art. 15972  LUK e effler	OEM 1424135M94 Disco PTO rigido in ferodo 280x165x3 mm 25x22EV Z.10	Art. 15642  	OEM 1424135M94 Disco PTO rigido in ferodo 280x165x3 mm 25x22EV Z.10
	Art. 15414  	OEM 1424149M95 3304586M91 Disco centrale metalceramico con molle parastrappi a 5 pale Ø 280 sinterizzato 40x35EV - Z.14	Art. 15280  	OEM 1423473M94 Cuscinetto reggispinta cambio 90x50x22 mm	Art. 15990  LUK	OEM 1423473M94 Cuscinetto reggispinta cambio 90x50x22 mm
	Art. 15751  	OEM 1442381X1 Cuscinetto reggispinta PTO 65x100x11 mm	Art. 15404  	OEM 392051X1 Cuscinetto reggispinta 95x50x21,5 mm	Art. 62583  	OEM 339599X1 - 3670612M1 Cuscinetto volano 20x47x14 mm Art. FAG 63869

(segue LANDINI
RUOTE)





































Frizioni e loro componenti

CLUTCHES - CLUTCH DISK - BEARING - COUPLING - LEVER - SET-REVISION

































11

11

segue LANDINI RUOTE

<p>6850-6860-6870-6880-7860-7870-7880-8860-8870-8880-9060-9080-9880/H BLIZZARD 65-75-85-95 ADVANTAGE 65-75-85-95 ATLAS 70-75-80-90-100 GHIBLI 80-90-100 REX 70F/L/GT-80F/L/GT-90F/GT-100GT SERIE 65F/GT/L-75F/GT/LV-85F/GT/LV VIEWMASTER 6880-7880-8880</p>	<p>Art. Kit 15931   </p>	<p>OEM 6521049M91 Kit composto da: - Meccanismo 15576 - Disco PTO 15974</p>	
	<p>Art. Kit 16068      </p>		<p>OEM 6625200A1 Kit composto da: - Meccanismo 15576 - Disco PTO 15974 - Cuscinetti 15404 - 15751 - 63869</p>
	<p>Art. 15576   OEM 3532192M96 3540478M91 - Meccanismo a 6 leve completo di disco centrale metalceramico a 8 pale - senza il disco PTO - Piatto Ø 310 mm (12")</p>	<p>Art. 15974   OEM 3105233M92 3311943M91 Disco PTO rigido in ferodo 25x22EV 310x175x3,5 (12")-Z.10</p>	<p>Art. 15578  OEM 3105233M92 3311943M91 Disco PTO rigido in ferodo 25x22EV 310x175x3,5 (12") - Z.10</p>
	<p>Art. 15577  OEM 3311942M91 Disco centrale metalceramico con molle parastrappi 8 pale Ø 310 sinterizzato (12") 40x35EV - Z.14</p>	<p>Art. 15751  OEM 1442381X1 Cuscinetto reggispinta PTO 65x100x11</p>	<p>Art. 15404  OEM 392051X1 Cuscinetto reggispinta 95x50x21,5 mm</p> <p>Art. 62583  OEM 339599X1 - 3670612M1 Cuscinetto volano 20x47x14 mm</p> <p>Art. FAG 63869</p>
<p>9500 - 9500 SPECIAL Originale VALEO</p>	<p>Art. Kit 15663    </p>		<p>OEM 44017803 1823150M91 - Meccanismo a 6 leve completo di disco centrale metalceramico - con disco PTO e cuscinetto reggispinta - Piatto Ø 310 mm (12")</p>
<p>10000 VECCHIA SERIE (segue LANDINI RUOTE)</p>	<p>Art. Kit 16071      </p>	<p>Art. 15416  OEM 1423267M91 Disco centrale metalceramico con molle parastrappi Ø 310 mm sinterizzato 45x40EV - Z.16</p>	<p>OEM 3541015M92 - 3302447M91 - 3302477M92 Kit composto da: - Meccanismo 15579 - Disco PTO 15419 - Cuscinetti 15864 - 15752 - 63872</p>
	<p>Art. 15579   OEM 3301229M91 3304468M92 - Meccanismo a 6 leve completo di disco centrale metalceramico - senza il disco PTO - Piatto Ø 310 mm (12")</p>	<p>Art. 15419   OEM 3310234M91 3135367M91 Disco PTO rigido in ferodo 310x175x3,5 mm 30x27EV - Z.16</p>	<p>Art. 15418  OEM 3310761M91 Disco centrale metalceramico rigido Ø 310 mm sinterizzato 48x44EV - Z.23</p>
	<p>Art. 15864  OEM 55x92x22 mm (tolleranza 8mm)</p>	<p>Art. 15752  OEM 392191X1 Cuscinetto reggispinta PTO - 75x115x13 mm</p>	<p>Art. 62586  OEM 392168X1 Cuscinetto volano 25x52x15 mm</p> <p>Art. FAG 63872</p>

segue LANDINI RUOTE

10000 S 12500 - 13000 14500	Art. Kit 15933   	OEM 3303137M94 Kit composto da: - Meccanismo 15580 - Disco PTO 15973				
	Art. 15580  	OEM 3303137M95 3540481M91 -1426390M94 - Meccanismo a 6 leve completo di disco centrale metalceramico a 8 pale - senza il disco PTO - Piatto Ø 330 mm - 13"	Art. 15973  	OEM 1426390M93 Disco PTO rigido in ferodo 327x175x3,8 mm 30x27EV - Z.16	Art. 15422 	OEM 1426390M93 Disco PTO rigido in ferodo 327x175x3,8 mm 30x27EV - Z.16
	Art. 15421 	OEM 1426389M91 3302049M93 Disco centrale metalceramico rigido a 8 pale Ø 327 mm sinterizzato 48x44EV - Z.23	Art. 15752 	OEM 392191X1 Cuscinetto reggispinta PTO 75x115x13 mm	Art. 15742 	OEM 3302143M91 Cuscinetto reggispinta cambio - 92x55x27mm
					Art. 62586 	OEM 392168X1 Cuscinetto volano 25x52x15 mm
17550 19000	Art. Kit 15904   	OEM 3580944M92 - 3713264M91 Meccanismo bi-disco Ø 310 mm				
GLOBUS 50-60-70 TOP	Art. Kit 15726   	OEM 3553260M92 Frizione semplice con disco avanzamento in organico - Piatto Ø 280 mm				
	Art. 15908  	OEM 3540866M92 Disco frizione Ø 280 31x35 mm - Z.18				
ALPINE 60-65-70-75- 80-85 GLOBUS 75-80TOP	Art. Kit 15949   	OEM 3654598M91 - 3648842M91 Kit meccanismo con disco Ø 310 mm				
			Art. 15950  	OEM 3654599M91 Disco a 6 pale Ø 310 mm 31x35 mm - Z.18		
LEGEND TOP 105-115-130-145- 165	Art. Kit 15729   	OEM 3542226M91 Frizione semplice con disco avanzamento sinterizzato - Piatto Ø 350 mm				
	Art. 15909  	OEM 3540443M91 Disco frizione Ø 350 48x52 mm - Z.24	Art. 16144  	OEM 3664102M91 Cuscinetto 65x112x45 mm		
(segue LANDINI RUOTE)						







































Frizioni e loro componenti

CLUTCHES - CLUTCH DISK - BEARING - COUPLING - LEVER - SET-REVISION

11































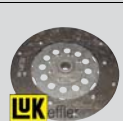









11

segue LANDINI RUOTE

LEGEND TECHNO 105-115-130-145-165 LANDPOWER 115 Blu - 125 - 130 Blu - 135 - 145 - 160 Blu - 165 LANDPOWER IVECO 125 - 135 - 145 - 165 LEGEND NG 115 - 120 - 125 TDI - 130/BLU - 135 TDI - 140 - 145 TDI - 160 BLU - 165 TDI	Art. Kit 15730  	OEM 3549179M91 - 3559804M91 Frizione doppia con disco avanzamento e PTO sinterizzati - Piatto Ø 350 mm		
	Art. 15909  	OEM 3540443M91 Disco frizione Ø 350 48x52 mm - Z.24	Art. 15910  	OEM 3541380M91 Disco frizione Ø 350 27x30 mm - Z.16
	Art. 16125  	OEM 3549201M91 Cuscinetto reggispinta 60x96x28 mm	Art. 16145  	OEM 3539704M91 Cuscinetto PTO 105x130x12,75 mm
LANDPOWER 125-165-185 LEGEND TOP 105-115-120-130-140-145-165-180-185	Art. Kit 16142  	OEM Frizione monodisco completa Ø 350 mm - Disco Ø 350 Z.24 a 8 pale con molle parastrappi - cuscinetto 60x97x26 mm		
MISTRAL 40 - 45 - 50 MISTRAL 2-045 MISTRAL 2-050	Art. Kit 15899  	OEM 4202165M91 Kit composto da: - Meccanismo - Disco PTO 15907		
	Art. 15906  	OEM 4202163M91 Disco frizione interno Ø 225 mm 27x30 mm - Z.16	Art. 15907  	OEM 4202164JA 6510438M91 Disco PTO Ø 225 mm 14x17 mm - Z.9
	Art. 15990  	OEM 1423473M94 Cuscinetto reggispinta cambio 90x50x22 mm	Art. 15280  	OEM 1423473M94 Cuscinetto reggispinta cambio 90x50x22 mm
MISTRAL 55 MISTRAL 2-055 MISTRAL 2-060	Art. Kit 16203  	OEM 6510439M91 Kit composto da: - Meccanismo - Disco PTO 15907		
	Art. 15990  	OEM 1423473M94 Cuscinetto reggispinta cambio 90x50x22 mm	Art. 63363  	OEM Cuscinetto PTO 100x65x18 mm
	Art. 62577  	Art. FAG 63895  	Art. 62577  	OEM Cuscinetto volano 15x35x11 mm
MYTHOS 90/100 - 110/115	Art. Kit 15914  	OEM 3559828M91 3657986M91 Meccanismo singolo con disco PTO Ø 330 mm		
	Art. 16125  	OEM 3549201M91 Cuscinetto reggispinta 60x96x28 mm		

(segue LANDINI RUOTE)

segue LANDINI RUOTE

VISION 100/105/80/85/90/95 Serie 5h 80/90/100/110/115 POWERMONDIAL 105/100 - 105 REX 85/95/105	Art. Kit 16094 	 	 	OEM 3667112M91 Kit frizione con disco avanzamento 5 pale Ø 330 mm Z.14	
TECHNOFARM 75/80/85	Art. Kit 16095 	 	 	OEM 3696565M91 - 3692006M92 Kit frizione con disco PTO rigido Ø 310 mm Z.13	
	Art. 63363  Art. FAG 63895	OEM 3695992M1 Cuscinetto PTO 100x65x18 mm	Art. 62597  Art. FAG 63883	OEM 369200M91 Cuscinetto PDF 45x75x16 mm	
DISCOVERY 65 - 85	Art. Kit 16032 	    			OEM Kit composto da: - Meccanismo 15552 - Disco PTO 15971 - Cuscinetti 15990 - 63895 - 63867
	Art. Kit 16031 	 	 	OEM Kit composto da: - Meccanismo 15552 - Disco PTO 15971	
	Art. 15552  	OEM 5138144-5154513- 5171493-5139339 Meccanismo a 6 leve completo di disco centrale in ferodo, senza il disco di PTO Piatto Ø 250 mm (10") Intercambiabile con meccanismo VALEO	Art. 15971  	Art. 15971 OEM 5128074-5154799 Disco PTO rigido in ferodo 250x155x3,5 mm 22x19EV - Z.13	Art. 15554 OEM 5128074-5154799 Disco PTO rigido in ferodo 250x155x3,5 mm 22x19EV - Z.13
	Art. 63363  Art. FAG 63895	OEM 24905350 Cuscinetto PTO 100x65x18 mm	Art. 15990  	OEM 5119290 5119875 - 5122028 - 87345759 Cuscinetto reggispinta cambio 90x50x22 mm	Art. 62581 OEM 28043280 Cuscinetto volano 17x47x14 mm Art. FAG 63867
	Art. 15280  	OEM 5119290 - 5119875 - 5122028 - 87345759 Cuscinetto reggispinta cambio 90x50x22 mm			
5-090D 5-100D 5-110D	 Art. Kit 16160 	 	 	OEM 4218588M93 Kit frizione Ø 310 mm a 6 leve con disco PTO Ø 280 mm a 4 pale Z.10	
	Art. 15990  	OEM 1423473M94 Cuscinetto reggispinta cambio 90x50x22 mm	Art. 62952  Art. FAG 63897	OEM 4219993M91 Cuscinetto reggispinta PTO 75x115x20 mm	





















Frizioni e loro componenti

CLUTCHES - CLUTCH DISK - BEARING - COUPLING - LEVER - SET-REVISION

11





































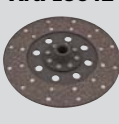

11

LANDINI CINGOLI

C3200 EXPORT - CS3200 EXPORT - CL3200 SPECIAL - C4000 C-CL 4000 SPECIAL	Art. 15206 	OEM 973372M1 Anello per frizione di sterzo in ferodo - dentatura esterna 219,2x152x6 - 71 denti		
35 C 4000-4500-4830- 5000-5500-5530- 5830-5860-5870- 6030-6500 TL 21 3500	Art. Kit 15940 			OEM 1423838M91 1423980M91-1850838M91-3306277M91 Meccanismo monodisco Ø 250 mm a 3 leve con collare e disco PTO
			Art. 15234 	OEM Disco frizione rigido 250x155x4,3 mm 35x29x5,5 mm Z.10
			Art. 62583 	OEM 339599X1 - 3670612M1 Cuscinetto volano 20x47x14 mm Art. FAG 63869
C4500 - C5500 - C6500 - C6830 - CF4830 - CF5030 - CF5830 - CF6030 - CF6060 - CF6830 TREKKER CF55 - CF60 - CF70	Art. 15176 	OEM 1423483M1 Anello per frizione di sterzo - in tessuto - dentatura esterna 239x180x4,8 - 28 denti	Art. 15389 	OEM 160.5715.0 Anello per frizione di sterzo - dentatura interna 229x171x2 mm 21 denti
6500 CINGOLI 6830C	Art. 15945 	OEM 3306280M91 Meccanismo monodisco Ø 280 mm	Art. 15169 	OEM 3306282M1 Disco frizione rigido 279x171x4,3 mm 35x29x5,5 mm - Z.10
			Art. 15272 	OEM Cuscinetto reggispinta piccolo 82x50x28
C6000 - CL600 - TL6C (segue LANDINI CINGOLI)	Art. 15419 	OEM 3310234M91 Disco PTO rigido in ferodo 310x175x3,5 mm 30x27EV - Z.16	Art. 15423 	OEM 1824733M1 Anello per frizione di sterzo in ferodo - dentatura esterna 239x180x5 - 28 denti
	Art. 15574 	OEM 3303238M93 3303000M96 - 3540479M91 - Meccanismo a 6 leve completo di disco centrale molleggiato in ferodo - fornito senza disco PTO - Piatto Ø 280 mm (11")	Art. 15972 	OEM 1424135M93 Disco PTO rigido in ferodo 280x165x3 mm 25x22EV Z.10
	Art. 15147 	OEM 1424123M91 Disco centrale in ferodo con molle parastrappi 280x165x4,4 mm 40x35EV - Z.14	Art. 15404 	OEM 392051X1 Cuscinetto reggispinta 95x50x21,5 mm
	Art. 15990 	OEM 1423473M94 Cuscinetto reggispinta cambio 90x50x22 mm	Art. 15280 	OEM 1423473M94 Cuscinetto reggispinta cambio 90x50x22 mm
	Art. 15178 	OEM 3300186M1 Anello per frizione di sterzo in ferodo - dentatura esterna 271x201x5 - 89 denti	Art. 15766 	OEM 3300184M1 Controdisco 260x190x2,5 mm 65 denti
(segue LANDINI CINGOLI)			Art. 15423 	OEM 1824733M1 Anello per frizione di sterzo in ferodo - dentatura esterna 239x180x5 mm - 28 denti

N.B. VALEO e LUK sono intercambiabili fra di loro

segue LANDINI CINGOLI

<p>C7800 - C7830 - TREKKER C75- C85-C95 DOPPIA FRIZIONE C4500-C5500-C6500- C4830-C5030-C5830- C6030-C6830. SERIE TREKKER</p> <p>N.B. VALEO e LUK sono intercambiabili fra di loro</p>	<p>Art. Kit 15928</p>    <p>OEM</p> <p>Kit composto da: - Meccanismo 15575 - Disco PTO 15972</p>		
	<p>Art. 15575</p>   <p>OEM 3304585M95 3540480M91 - Meccanismo a 6 leve completo di disco centrale metalceramico a 5 pale - fornito senza disco PTO - Piatto Ø 280mm (11")</p>	<p>Art. 15972</p>   <p>OEM 1424135M94 Disco PTO rigido in ferodo 280x165x3 mm 25x22EV Z.10</p>	<p>Art. 15642</p>  <p>OEM 1424135M94 Disco PTO rigido in ferodo 280x165x3 mm 25x22EV Z.10</p>
	<p>Art. 15414</p>  <p>OEM 1424149M95 3306586M91 Disco centrale metalceramico con molle - parastrappi a 5 pale Ø 280 mm sinterizzato 40x35EV - Z.14</p>	<p>Art. 15990</p>   <p>OEM 1423473M94 Cuscinetto reggispinta cambio 90x50x22 mm</p>	<p>Art. 15280</p>  <p>OEM 1423473M94 Cuscinetto reggispinta cambio 90x50x22 mm</p>
		<p>Art. 15751</p>  <p>OEM 1442381X1 Cuscinetto reggispinta PTO 65x100x11 mm</p>	<p>Art. 62583</p>   <p>OEM 339599X1 - 3670612M1 Cuscinetto volano 20x47x14 mm</p> <p>Art. FAG 63869</p>
C14000	<p>Art. 15423</p>  <p>OEM 1824733M1 Anello per frizione di sterzo in ferodo - dentatura esterna 239x180x5 - 28 denti</p>	<p>Art. 15389</p>  <p>OEM 975743M1 Anello per frizione di sterzo - dentatura interna 229x171x2 - 21 denti</p>	
<p>TREKKER C65F - C70N/F - C75N/F - C80N/F</p> <p>N.B.: VALEO e LUK sono intercambiabili fra di loro</p>	<p>Art. Kit 16037</p>       <p>OEM</p> <p>Kit composto da: - Meccanismo 15575 - Disco PTO 15972 - Cuscinetti 15990 - 15751 - 63869</p>		
	<p>Art. Kit 15928</p>    <p>OEM 3532239M93</p> <p>Kit composto da: - Meccanismo 15575 - Disco PTO 15972</p>		
	<p>Art. 15575</p>   <p>OEM 3304585M95 3540480M91 - Meccanismo a 6 leve completo di disco centrale metalceramico a 5 pale - fornito senza disco PTO - Piatto Ø280 mm (11")</p>	<p>Art. 15972</p>   <p>OEM 1424135M94 Disco PTO rigido in ferodo 280x165x3 mm 25x22EV Z.10</p>	<p>Art. 15642</p>  <p>OEM 1424135M94 Disco PTO rigido in ferodo 280x165x3 mm 25x22EV Z.10</p>
	<p>Art. 15414</p>  <p>OEM 1424149M95 3304586M91 Disco centrale metalceramico con molle parastrappi a 5 pale Ø 280 sinterizzato 40x35EV - Z.14</p>	<p>Art. 15280</p>  <p>OEM 1423473M94 Cuscinetto reggispinta cambio 90x50x22 mm</p>	<p>Art. 15990</p>   <p>OEM 1423473M94 Cuscinetto reggispinta cambio 90x50x22 mm</p>
	<p>Art. 15751</p>  <p>OEM 1442381X1 Cuscinetto reggispinta PTO 65x100x11 mm</p>	<p>Art. 15404</p>  <p>OEM 392051X1 Cuscinetto reggispinta 95x50x21,5 mm</p>	<p>Art. 62583</p>   <p>OEM 339599X1 - 3670612M1 Cuscinetto volano 20x47x14 mm</p> <p>Art. FAG 63869</p>

(segue LANDINI CINGOLI)

Frizioni e loro componenti

CLUTCHES - CLUTCH DISK - BEARING - COUPLING - LEVER - SET-REVISION

11

11

segue LANDINI CINGOLI

TREKKER C65F-
C75F-C80F- C80F/M
- C85/85F-C90/F/M-
C95/95F-C100/100F/
C105/F/M

**Art. Kit
15931**



OEM 6521049M91

Kit composto da:
- Meccanismo 15576
- Disco PTO 15974

**Art. Kit
16068**



OEM 6625200A1

Kit composto da:
- Meccanismo 15576
- Disco PTO 15974
- Cuscinetti 15404 - 15751 - 63869

Art. 15576



OEM 3532192M96
3540478M91
- Meccanismo a 6 leve
completo di disco centrale
metalceramico a 8 pale -
senza il disco PTO
- Piatto Ø 310 mm (12")

Art. 15974



OEM 3105233M92
3311943M91
Disco PTO rigido in
ferodo
25x22EV
310x175x3,5 (12")-Z.10

Art. 15578



OEM 3105233M92
3311943M91
Disco PTO rigido in
ferodo
25x22EV
310x175x3,5 (12") - Z.10

Art. 15577



OEM 3311942M91
Disco centrale
metalceramico con molle
parastrappi 8 pale
Ø 310 sinterizzato (12")
40x35EV - Z.14

Art. 15751



OEM 1442381X1
Cuscinetto reggispinta
PTO 65x100x11

Art. 15404



OEM 392051X1
Cuscinetto reggispinta
95x50x21,5 mm

Art. 62583



**Art. FAG
63869**

OEM 339599X1 -
3670612M1
Cuscinetto volano
20x47x14 mm



















TREKKER NEW
80, 90 (2000->2003)
75, 85, 95, 105
(2003->2007)
RETYLING
80, 90, 100, 105
(2011->...)

Art. 16210





OEM 3535760M91
Disco sinterizzato per
frizione di sterzo

LAVERDA MIETITREBBIE

M84 - M92	Art. 15424  OEM Meccanismo monodisco con molle a diaframma Piatto Ø 215 mm	Art. 15116  OEM 3.010.07850 Disco frizione rigido in ferodo 216x152x3,5 mm 35x30x4 mm - Z.10	Art. 15055  OEM Cuscinetto reggispinta
M100 - M112	Art. 15425  OEM 3.016.24302 - Meccanismo monodisco a molle elicoidali - Piatto Ø 250 mm	Art. 15117  OEM 3.015.25750 Disco frizione centrale rigido in ferodo 250x155x3,5 mm 35x30x4 mm - Z.10	Art. 15364  OEM 4561428 Manicotto
		Art. 15365  OEM 541743 Cuscinetto reggispinta	
M120 - M132 - M150 - TA150 - M152 - M1000 AL - AM 1200		Art. 15053  OEM 3.018.48250 Disco frizione centrale rigido in ferodo 275x165x3,5 mm 35x30x4 mm - Z.10	Art. 15364  OEM 4561428 Manicotto
		Art. 15365  OEM Cuscinetto reggispinta	
M52 (2ª serie) - M152 - AUTOLIVELLANTI: 3450R - 3500		Art. 15187  OEM 3.001.14836 Disco frizione centrale rigido in ferodo 300x193x3,6 mm 35x30x4 mm - Z.10	Art. 15364  OEM 4561428 Manicotto
		Art. 15365  OEM Cuscinetto reggispinta	
3650 - 3650 R - 3750 - 3750 R - 3850 - 3850 R	Art. Kit 15394  LUK	 OEM KIT meccanismo presa di movimento con disco	Art. 15293  OEM Disco centrale metalceramico a 7 pale Rigido Ø 350 mm sinterizzato 50x45EV - Z.24
	Art. 15445  OEM Disco presa di movimento rigido in ferodo 352x195x4,3 mm 50x45EV - Z.24	Art. 15410  OEM Manicotto con cuscinetto reggispinta	Art. 15883  OEM 112x65x42 mm Cuscinetto reggispinta

LEO

MOTOZAPPA M4 (10/12/14 HP)	Art. 15354  OEM Frizione monodisco a molle elicoidali Piatto Ø 140 mm	Art. 15731  OEM Disco frizione rigido 140x96x7,5 mm 17x14x4 mm Z.6	
----------------------------	---	--	--













Frizioni e loro componenti

CLUTCHES - CLUTCH DISK - BEARING - COUPLING - LEVER - SET-REVISION



















11

11

MAB

MOTOCOLTIVATORI PANDA 135 10 HP	Art. 15001 	OEM 592431394 Frizione conica Ø 103x100 mm Albero Ø 22,5 mm Conicità 1:5 15x12EV - Z.8		
MOTOZAPPA TALPINA	Art. 15595 	OEM Frizione Ø 94 mm a dischi multipli 3 dischi	Art. 15596 	OEM Disco 85,5x60x4,5 mm
MOTOZAPPA	Art. 15597 	OEM Frizione Ø 94 mm a dischi multipli 4 dischi	Art. 15596 	OEM Disco 85,5x60x4,5 mm
MOTOZAPPA	Art. 15849 	OEM Frizione Ø 103x82 mm a 3 dischi 12x15EV - Z.8 Albero Ø 23 mm	Art. 15630 	OEM Disco frizione sinterizzato Ø 93 mm
MOTOZAPPA (motore HONDA)	Art. 15850 	OEM Frizione Ø 103x106 mm a 3 dischi 12x15EV - Z.8 Albero Ø 20 mm	Art. 15630 	OEM Disco frizione sinterizzato Ø 93 mm
MOTOCOLTIVATORE TALPA TRATTORINO TALPA 4 RM	Art. 15016 	OEM Frizione monodisco a molle elicoidali Piatto Ø 155 mm	Art. 15033 	OEM Disco frizione rigido in ferodo 155x114x4,5 mm 17x14x4 mm - Z.6
				Art. 15051 OEM  Cuscinetto reggispinta
				Art. 15048 OEM  Manicotto

MASSEY FERGUSON RUOTE

<p>133 fino a matr. 217333 135 made in FR fino a matr. 350000 135 made in GB fino a matr. 1210069 140 fino a matr. 382043 145</p>	<p>Art. Kit new 16169</p>    <p>OEM 962193M94</p> <p>Kit composto da: - Meccanismo 15901 - Disco PTO 15183</p>		
	<p>Art. 15901 OEM 3620401M91 Meccanismo</p> 	<p>Art. 15127 OEM 899823M91 1753753M92 - 3620411M91 Disco PTO rigido in ferodo 225x145x3,5 mm 44x38x7 mm -Z.10</p> 	<p>Art. 15183 OEM 890302M91 3620410M91 Disco frizione centrale rigido in ferodo 273x178x3,5 mm 29x23x4 mm -Z.10</p> 
			<p>Art. 15514 OEM</p>  <p>Cuscinetto reggispinta</p>
<p>MF 33A3 - MF135 (fino al telaio 121069) - MF 133 MK III - MF 135 AD3 (Dal telaio 121070) - MF 135 (fino al telaio 439190) - MF 135MK III Francia - MF 135 MK III Export - MF 148 MK III - MF 148 (fino al telaio 605134) - MF 152 - MF 165 (fino al telaio 564619) - MF 175 - MF 178 (fino al telaio 729574) - MF550 - MF560 - MF565 - MF575 - MF765</p>	<p>Art. 15183 OEM 890302M91 3620410M91 Disco frizione centrale rigido in ferodo 273x178x3,5 mm 29x23x4 mm Z.10</p> 	<p>Art. 15127 OEM 899823M91 1753753M92 - 3620411M91 Disco PTO rigido in ferodo 225x145x3,5 mm 44x38x7 mm - Z.10</p> 	
<p>30E 133 da matr. 275041 135 made in GB da matr. 439191 135 made in FR da matr. 275041 135 da matr. 382043 145 - 148 - 158 - 230 - 231 - 235 - 240 - 245 - 250 - 255 - 261 - 340 - 342 - 350 - 550</p>	<p>Art. Kit new 16170</p>      <p>OEM</p> <p>Kit composto da: - Meccanismo 15891 - Disco PTO 15184 - Cuscinetto 15514</p>		
	<p>Art. 15891 OEM 3599463M91 3610273M91 1867438M91 Meccanismo Ø 300 mm</p> 	<p>Art. 15892 OEM 3478359M1 1867386M91 3620417M91 Disco PTO rigido organico Ø 250 mm 38x41 mm - Z.25</p> 	<p>Art. 15184 OEM 1866042M91 Disco frizione centrale rigido in ferodo 302x197x4 mm 29x23x4 mm -Z.10</p> 
		<p>Art. 15433 OEM 887900M91 1865836M91 Disco PTO rigido in ferodo 250x155x3,5 mm 44x38x7 mm -Z.10</p> 	<p>Art. 15514 OEM</p>  <p>Cuscinetto reggispinta</p>

(segue MASSEY FERGUSON RUOTE)















Frizioni e loro componenti

CLUTCHES - CLUTCH DISK - BEARING - COUPLING - LEVER - SET-REVISION

























11

11

segue MASSEY FERGUSON RUOTE

<p>MF 135 (Dal telaio 439191) - MF 148 (Dal telaio 605135) - MF 165 (Dal telaio 564620) - MF 165 Nuova serie - MF 168 - MF 175 Nuova serie - MF 178 (Dal telaio 729575) - MF 185 - MF 188 - MF 235 - MF 240 (fino al telaio 522354) - MF 245 - MF 250 - MF 255 - MF 260 - MF 265 - MF 275 - MF 290 (Asia - Africa - Australia) - MF 290 (Europa) - MF 575 (Francia) - MF 590 - MF 675 - MF 675/4 - MF 690 - MF 690/4 - MF 1080.8 - MF 1080.8 suffr. - 1845 - 1945 - 283 - 2845 - 293 - 2945 - T/VALEO</p>	<p>Art. 15184 OEM 1866042M93 Disco frizione centrale rigido in ferodo 302x197x4 mm 29x23x4 mm Z.10</p> 	<p>Art. 15433 OEM 887900M91 1865836M91 Disco PTO rigido in ferodo 250x155x3,5 mm 44x38x7 mm - Z.10</p> 	<p>Art. 15514 OEM Cuscinetto reggispinta</p> 
<p>165 168 178</p>	<p>Art. 15902 OEM 3620402M91 Meccanismo Ø 280 mm</p> 	<p>Art. 15127 OEM 899823M91 1753753M92 - 3620411M91 Disco PTO rigido in ferodo 225x145x3,5 mm 44x38x7 mm -Z.10</p> 	<p>Art. 15183 OEM 890302M91 3620410M91 Disco frizione centrale rigido in ferodo 273x178x3,5 mm 29x23x4 mm -Z.10</p> 
			<p>Art. 15514 OEM Cuscinetto reggispinta</p> 
<p>185 fino a matr. 317618 188 da matr. 358839</p>	<p>Art. 15903 OEM 1867005M91 Meccanismo Ø 300 mm</p> 	<p>Art. 15184 OEM 1866042M91 Disco frizione centrale rigido in ferodo 302x197x4 mm 29x23x4 mm -Z.10</p> 	<p>Art. 15892 OEM 3478359M1 1867386M91 3620417M91 Disco PTO rigido organico Ø 250 mm 38x41 mm -Z.25</p> 
			<p>Art. 15514 OEM Cuscinetto reggispinta</p> 
<p>155 - 158 - 165 - 168 - 265 - 275</p>	<p>Art. Kit 16173 </p> 		<p>OEM 3599494M92 Kit frizione a 3 leve Ø 300 mm completo di: Disco PTO in acciaio 38x41 Z.25 Disco centrale rigido in ferodo 23x29 Z.10 Cuscinetto 63,5x100x22 Cuscinetto 17x40x12</p>
<p>185 - 188 - 285 (motore 4.248) - 290 (segue MASSEY FERGUSON RUOTE)</p>	<p>Art. Kit 16174 </p> 		<p>OEM 3599496M93 Kit frizione a 3 leve Ø 300 mm completo di: Disco PTO in acciaio 38x41 Z.25 Disco centrale rigido in ferodo 23x29 Z.10 Cuscinetto 63,5x100x22 Cuscinetto 17x40x12</p>

segue MASSEY FERGUSON RUOTE

154S - 174S - 233 - 234S - 253 - 254S.4WD - 263 - 273 - 274S 134C/N - 154N/F/S/V - 164T/F/S/V 184S - 194S - 283 - 284S.4WD - 293 - 294S.4WD	Art. 15574  OEM 3303238M93 3303000M96 - 3540479M91 - Meccanismo a 6 leve completo di disco centrale molleggiato in ferodo - fornito senza disco PTO - Piatto Ø 280 mm (11")	Art. 15972  OEM 1424135M94 Disco PTO rigido in ferodo 280x165x3 mm 25x22EV Z.10	Art. 15642  OEM 1424135M93 Disco PTO rigido in ferodo 280x165x3 mm 25x22EV Z.10	
	Art. 15147  OEM 3311538M92 Disco centrale in ferodo con molle parastrappi 280x165x4,4 mm 40x35EV - Z.14	Art. 15404  OEM 392051X1 Cuscinetto reggispinta 95x50x21,5 mm	Art. 15751  OEM 1442381X1 Cuscinetto reggispinta PTO 65x100x11 mm	
	Art. 15990  OEM 1424135M94 Cuscinetto reggispinta cambio 90x50x22 mm	Art. 15280  OEM 1424135M94 Cuscinetto reggispinta cambio 90x50x22 mm	Art. 62583  OEM 339599X1 - 3670612M1 Cuscinetto volano 20x47x14 mm Art. FAG 63869	
	Art. Kit 16037     	OEM Kit composto da: - Meccanismo 15575 - Disco PTO 15972 - Cuscinetti 15990 - 15751 - 63869		
	Art. Kit 15928  	OEM Kit composto da: - Meccanismo 15575 - Disco PTO 15972		
Art. 15575  OEM 3304585M95 3540480M91 - Meccanismo a 6 leve completo di disco centrale metalceramico a 5 pale - fornito senza disco PTO - Piatto Ø 280 mm (11")	Art. 15972  OEM 1424135M94 Disco PTO rigido in ferodo 280x165x3 mm 25x22EV - Z.10	Art. 15642  OEM 1424135M94 Disco PTO rigido in ferodo 280x165x3 mm 25x22EV - Z.10		
Art. 15414  OEM 1424149M95 3304586M91 Disco centrale metalceramico con molle parastrappi a 5 pale 280 sinterizzato 40x35EV - Z.14	Art. 15990  OEM 1424135M94 Cuscinetto reggispinta cambio 90x50x22 mm	Art. 15280  OEM 1423473M94 Cuscinetto reggispinta cambio 90x50x22 mm		
		Art. 15751  OEM 1442381X1 Cuscinetto reggispinta PTO 65x100x11 mm		
3680 3690 3670	Art. Kit 15904  	OEM 3580944M92 Meccanismo bi-disco Ø 310 mm		

(segue MASSEY
FERGUSON RUOTE)

Frizioni e loro componenti

CLUTCHES - CLUTCH DISK - BEARING - COUPLING - LEVER - SET-REVISION

11

11
new

segue MASSEY FERGUSON RUOTE

377 - 387 - 397

Art. Kit 15931



OEM 6521049M91

Kit composto da:
- Meccanismo 15576
- Disco PTO 15974

Art. Kit 16068



OEM 6625200A1

Kit composto da:
- Meccanismo 15576
- Disco PTO 15974
- Cuscinetti 15404 - 15751 - 63896

Art. 15576



OEM 3532192M96
3540478M91
- Meccanismo a 6 leve completo di disco centrale metalceramico a 8 pale - senza il disco PTO
- Piatto Ø 310 mm (12")

Art. 15974



OEM 3105233M92
3311943M91
Disco PTO rigido in ferodo
25x22EV
310x175x3,5 mm (12")
Z.10

Art. 15578

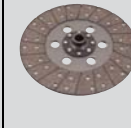

OEM 3105233M92
3311943M91
Disco PTO rigido in ferodo
25x22EV
310x175x3,5 mm (12")
Z.10

Art. 15577



OEM 3105232M91
3311942M91
Disco centrale metalceramico con molle parastrappi 8 pale Ø 310 mm sinterizzato (12")
40x35EV - Z.14

Art. 15751



OEM 1442381X1
Cuscinetto reggispinta PTO 65x100x11 mm

Art. 15404



OEM 392051X1
Cuscinetto reggispinta 95x50x21,5 mm

Art. 62583



OEM 339599X1 - 3670612M1
Cuscinetto volano 20x47x14 mm

Art. FAG 63869

390T - 396 - 398 - 399
4240 - 4245/HV
- 4255/HV - 4260
- 4265 - 4270
4355 - 4360 - 4365 - 4370

Art. Kit 16147



OEM

Kit frizione Ø 330 mm a 3 leve completo di:
Disco a 5 pale Ø 330 Z.21 con molle parastrappi.
Cuscinetto 63,5x100x23
Cuscinetto 17x40x12

2200 - 2205 - 2210 - 2220

Art. Kit 15726



OEM

Frizione semplice con disco avanzamento in organico
- Piatto Ø 280 mm

Art. 15908



OEM
Disco frizione Ø 280 mm - 31x35 mm - Z.18

1014

Art. Kit 16071



OEM 3541015M92 - 3302447M91 - 3302477M92

Kit composto da:
- Meccanismo 15579
- Disco PTO 15419
- Cuscinetti 15742 - 15752 - 63872

Art. 15579



OEM 3301229M91
3304468M92
- Meccanismo a 6 leve completo di disco centrale metalceramico - senza il disco PTO
- Piatto Ø 310 mm (12")

Art. 15419



OEM 3310234M91
3135367M91
Disco PTO rigido in ferodo
310x175x3,5 mm
30x27EV - Z.16

Art. 15418



OEM 3310761M91
Disco centrale metalceramico rigido Ø 310 sinterizzato 48x44EV - Z.23

Art. 15742



OEM 3302143M91
Cuscinetto reggispinta cambio - 92x55x27 mm

Art. 15752



OEM 39219X1
Cuscinetto reggispinta PTO - 75x115x13 mm

Art. 62586































OEM 392168X1
Cuscinetto volano 25x52x15 mm

Art. FAG 63872

(segue MASSEY FERGUSON RUOTE)

segue MASSEY FERGUSON RUOTE

1007 - 1014 - 1024 - 1114 - 1134	Art. Kit 15933   	OEM Kit composto da: - Meccanismo 15580 - Disco PTO 15973	
	Art. 15580  OEM 3303137M95 3540481M91 -1426390M94 - Meccanismo a 6 leve completo di disco centrale metalceramico a 6 pale - senza il disco PTO - Piatto Ø 330 mm - 13"	Art. 15973  OEM 1426390M93 Disco PTO rigido in ferodo 327x175x3,8 mm 30x27EV Z.16	Art. 15422  OEM 1426390M93 Disco PTO rigido in ferodo 327x175x3,8 mm 30x27EV Z.16
	Art. 15421  OEM 1426389M91-3302049M93 Disco centrale metalceramico rigido a 6 pale Ø 327 mm sinterizzato 48x44EV - Z.23	Art. 15419  OEM 3310234M91 3105367M91 Disco PTO rigido in ferodo 310x175x3,5 mm 30x27EV - Z.16	
	Art. 15742  OEM 3302143M91 Cuscinetto reggispinta cambio - 92x55x27mm	Art. 15752  OEM 392191X1 Cuscinetto reggispinta PTO 75x115x13 mm	Art. 62586  OEM 392168X1 Cuscinetto volano 25x52x15 mm Art. FAG 63872
2405 2410 2415	Art. Kit 15987   	OEM 0.012.5851.4/20 Kit frizione doppia a 6 leve con disco interno Ø 230 mm	
		Art. 62952  OEM Cuscinetto reggispinta PTO 75x115x20 mm Art. FAG 63897	Art. 62577  OEM Cuscinetto volano 15x35x11 mm Art. FAG 63863
3050 - 3070 - 3080 3090 - 3095	Art. 15647  OEM 3713531M1 Meccanismo con molle a diaframma Piatto Ø 330 mm	Art. 15964  OEM Disco centrale in ferodo con molle parastrappi 330x196x4,2 mm 41x36,5EV - Z.24	Art. 15803  OEM Disco centrale in ferodo con molle parastrappi 330x196x4,2 mm 41x36,5EV - Z.24
	Art. 15965  OEM Disco centrale metalceramico a 6 pale con molle parastrappi Ø 330 mm sinterizzato 41x45,3 mm - Z.21	Art. 15749  OEM Disco centrale metalceramico a 6 pale con molle parastrappi Ø330 mm sinterizzato 41x45,3 mm - Z.21	Art. 15292  OEM 3615366M1 Disco centrale metalceramico a 7 pale con molle parastrappi Ø 330 mm - 50x46V - Z23
	Art. 15984  OEM 0.016.6105.3 Disco centrale metalceramico a 6 pale con molle parastrappi Ø 330 mm sinterizzato 41x36,5EV - Z.24	Art. 15744  OEM 2.2999.475.0 Cuscinetto reggispinta 90x55x22 mm	Art. 15883  OEM 2.2999.510.0 2.2999.207.0 2.2999.443.0 112x65x42 mm Cuscinetto reggispinta
3435V/S/F 3445V/S/F 3455V/S/F (segue MASSEY FERGUSON RUOTE)	Art. 15746  OEM Meccanismo con molla a diaframma piatto Ø 310 mm	Art. 15441  OEM Disco centrale in ferodo con molle parastrappi 310x191x3,5 mm 40x36,5 mm - Z.24	Art. 15744  OEM Cuscinetto reggispinta cambio 90x55x22 mm

Frizioni e loro componenti

CLUTCHES - CLUTCH DISK - BEARING - COUPLING - LEVER - SET-REVISION

11

11
new























segue MASSEY FERGUSON RUOTE

3645 F/GE/S 3655 F/GE/S 3070	Art. Kit 16222    	OEM VA205510
	Art. Kit 16223    	OEM VA205511

















Kit composto da:
- Meccanismo Ø 310
- Disco sinterizzato a 5 pale
- Cuscinetto

Kit composto da:
- Meccanismo Ø 310
- Disco sinterizzato a 6 pale
- Cuscinetto

MASSEY FERGUSON CINGOLI

MF 101C	Art. 15206  OEM 973372M1 Anello per frizione di sterzo in ferodo dentatura esterna 219,2x152x6 mm - 71 denti			
MF 134C - MF 154C - MF 174C	Art. Kit 15928   	OEM	Kit composto da: - Meccanismo 15575 - Disco PTO 15972	
	Art. 15575  OEM 3304585M95 3540480M91 - Meccanismo a 6 leve completo di disco centrale metalceramico a 5 pale - fornito senza disco PTO - Piatto Ø 280 mm (11")	Art. 15972  OEM 1424135M94 Disco PTO rigido in ferodo 280x165x3 mm 25x22EV - Z.10	Art. 15642  OEM 1424135M94 Disco PTO rigido in ferodo 280x165x3 mm 25x22EV - Z.10	
	Art. 15414  OEM 1424149M95 3304586M91 Disco centrale metalceramico con molle parastrappi a 5 pale 280 sinterizzato 40x35EV - Z.14	Art. 15404  OEM 392051X1 Cuscinetto reggispinta 95x50x21,5 mm	Art. 15751  OEM 1442381X1 Cuscinetto reggispinta PTO 65x100x11 mm	
	Art. 15990  OEM 1424135M94 Cuscinetto reggispinta cambio 90x50x22 mm	Art. 15280  OEM 1423473M94 Cuscinetto reggispinta cambio 90x50x22 mm	Art. 62583  OEM 339599X1 - 3670612M1 Cuscinetto volano 20x47x14 mm Art. FAG 63869	
	Art. 15423  OEM 1824733M1 Anello per frizione di sterzo - in tessuto - dentatura esterna 239x180x5 mm - 28 denti	Art. 15389  OEM 975743M1 Anello per frizione di sterzo - dentatura interna 229x171x2 mm - 21 denti		
	Art. 15940   solo per MF134C-154C	Art. 15169  OEM 1423838M91 1423980M91-1850838M91-3306277M91 Meccanismo monodisco Ø 250 mm a 3 leve con collare e disco PTO	Art. 15234  OEM Disco frizione rigido 250x155x4,3 mm 35x29x5,5 mm Z.10	
(segue MASSEY FERGUSON CINGOLI)	Art. 15945  solo per MF174C	Art. 15169  OEM Disco frizione rigido 279x171x4,3 mm 35x29x5,5 mm Z.10	Art. 15272  OEM Cuscinetto reggispinta piccolo 82x50x28	

segue MASSEY FERGUSON CINGOLI

MF 144C - MF 164C	Art. 15111  OEM 1424123M91 Disco centrale rigido in ferodo 280x165x3,8 mm 40x35EV - Z.14	Art. 15972  OEM 1424135M91 Disco PTO rigido in ferodo 280x165x3 mm 25x22EV - Z.10	Art. 15642  OEM1424135M91 Disco PTO rigido in ferodo 280x165x3,5 mm 25x22EV - Z.10
	Art. 15423  OEM 1824733M1 Anello per frizione di sterzo - in tessuto - dentatura esterna 239x180x5 mm - 28 denti	Art. 15389  OEM 975743M1 Anello per frizione di sterzo - dentatura interna 229x171x2 mm - 21 denti	
MF 194C	Art. 15414  OEM 3304584M92 1424149M95 3306586M91 Disco centrale metalceramico con molle parastrappi a 5 pale Ø 280 mm sinterizzato 40x35EV - Z.14	Art. 15972  OEM 1424135M91 Disco PTO rigido in ferodo 280x165x3 mm 25x22EV - Z.10	Art. 15642  OEM 1424135M91 Disco PTO rigido in ferodo 280x165x3,5 mm 25x22EV - Z.10
			Art. 15178  OEM 3300186M1 Anello per frizione di sterzo in ferodo - dentatura esterna 271x201x5 mm 89 denti
MF 234CF - MF 254C - MF 254CF - MF 274C - MF 274CF	Art. 15972  OEM 1424135M91 Disco PTO rigido in ferodo 280x165x3 mm 25x22EV - Z.10	Art. 15642  OEM 1424135M91 Disco PTO rigido in ferodo 280x165x3,5 mm 25x22EV - Z.10	
	Art. 15423  OEM 1824733M1 Anello per frizione di sterzo - in tessuto - dentatura esterna 239x180x5 mm - 28 denti	Art. 15389  OEM 975743M1 Anello per frizione di sterzo - dentatura interna 229x171x2 mm - 21 denti	
MF 294C	Art. 15414  OEM 3304584M92 1424149M95 3306586M91 Disco centrale metalceramico con molle parastrappi a 5 pale Ø 280 mm sinterizzato 40x35EV - Z.14	Art. 15972  OEM 1424135M91 Disco PTO rigido in ferodo 280x165x3 mm 25x22EV - Z.10	Art. 15642  OEM 1424135M91 Disco PTO rigido in ferodo 280x165x3,5 mm 25x22EV - Z.10

MIRA

MOTOZAPPA MOTOCOLTIVATORE	Art. 15851  OEM Frizione Ø 103x87 mm a 4 dischi 12x15EV Z.8 - Albero Ø 23 mm		
------------------------------	---	--	--









Frizioni e loro componenti

CLUTCHES - CLUTCH DISK - BEARING - COUPLING - LEVER - SET-REVISION













11

11

NIBBI BRUNO

TRATTORINI: G119 - G219 - G520 - G521	Art. 15296 OEM  Meccanismo monodisco a molle elicoidali Piatto Ø 184 mm	Art. 15213 OEM  Disco frizione rigido in ferodo 184x127x3,5 mm 25x21EV Z.15	Art. 15052 OEM  Cuscinetto reggispinta 68x36x19 mm
			Art. 15047 OEM  Manicotto
MOTOCOLTIVATORI G519 - G719	Art. 15644 OEM  Disco frizione rigido 100x63x2 mm 24,5x20EV - Z.15 per G719	Art. 15645 OEM  Disco frizione rigido 135x91x2,2 mm 24,5x20EV - Z.15 per G519	
TRATTORINI: 344 (doppia frizione)	Art. 15098 OEM  Disco centrale rigido in ferodo 216x152x3,8 mm 35x31EV - Z.18	Art. 15099 OEM  Disco PTO rigido in ferodo 216x152x3,9 mm 23x20EV - Z.20	

NIBBI DECIMO

MOTAZAPPA CON MOTORE MINARELLI	Art. 15598 OEM  Frizione conica Ø 103x79 mm Albero Ø 16,7 mm Conicità 1:5 15x12EV - Z.8		
MOTAZAPPA	Art. 15604 OEM  Frizione multidisco Ø 114 mm Completa di dischi	Art. 15605 OEM  Serie dischi completa 104x77,5x2,6 mm	
MOTOCOLTIVATORI MAJOR	Art. 15002 OEM  Frizione monodisco a molle a diaframma Piatto Ø 110 mm	Art. 15019 OEM  Disco frizione rigido 110x58x1,5 mm 15x12EV - Z.8	Art. 15042 OEM  Manicotto con cuscinetto reggispinta
		Art. 15050 OEM  Cuscinetto reggispinta	Art. 15057 OEM  Leva a forcella
MOTOCOLTIVATORI GRIFO - ARGO MOTAZAPPA GRIFO EXTRA	Art. 15215 OEM  Disco frizione rigido 120x78x3 mm 17x14EV - Z.9 Solo per motocoltivatori GRIFO e ARGO	Art. 15643 OEM  Disco frizione rigido 144x102x3 mm 26x21x3V - Z.10 Solo per motozappa GRIFO EXTRA	
MOTOCOLTIVATORI	Art. 15339 OEM  Frizione bidisco completa di disco centrale Piatto Ø 110 mm	Art. 15022 OEM  Disco frizione rigido in sinterizzato Ø 110 mm sinterizzato 15x12EV - Z.8	Art. 15042 OEM  Manicotto con cuscinetto reggispinta

PASQUALI

SERIE 938 - 939 - 952 - 953	Art. 15318 	OEM 939.183.0 Frizione conica Ø 103x69 mm Albero Ø 22,5 mm Conicità 1:5 15x12EV - Z.8			
MOTOCOLTIVATORI 461 - 475 - 478 (DAL 1995 IN AVANTI)	Art. 15606 	OEM Frizione Ø 103x68 mm a dischi multipli con 5 dischi 15x12EV - Z.8 Albero Ø23 - Conicità 1:5	Art. 15630 	OEM 15653 Disco frizione Ø 93 mm	Art. 15653 OEM  Serie dischi
MOTOFALCIATRICI (DAL 1995 IN AVANTI)	Art. 15607 	OEM Frizione Ø 103x85,5 mm a dischi multipli con 6 dischi 15x12EV - Z.8 Albero Ø 22,5 Conicità 1:5	Art. 15630 	OEM 15654 Disco frizione Ø 93 mm	Art. 15654 OEM  Serie dischi
MOTOCOLIVATORI: 921 - 922 - 934 - 917 - 923 - 924 - 933	Art. 15007 	OEM Meccanismo monodisco a molle elicoidali Piatto Ø 160 mm	Art. 15039 	OEM Disco frizione rigido in ferodo 160x108x2,5 mm 22x19x3,5 mm - Z.10	
MOTOCOLIVATORI: 904 - 925	Art. 15880 	OEM Meccanismo frizione Piatto Ø 160 mm	Art. 15216 	OEM 930.1020 Disco frizione rigido in ferodo 160x108x3,5 mm 29,5x23x4 - Z.10	
MOTOCOLIVATORI: 906 - 910 (18 HP) 931 - 937 - 940 - 941 944 - 945 - 946 - 946T - 947 - 986	Art. 15538 	OEM Frizione monodisco con molle elicoidali Ø 180 mm	Art. 15041  Motocoltiv. 945	OEM Disco frizione rigido in ferodo 180x124x3,5 mm 29,5x23x4 mm - Z.10	Art. 15669 OEM  Reggispinta con battente 30x62x20 mm appoggio piano
Serie 940 - 941 - 944 - 945 - 946 - 947 - 986 	Art. 16152 	OEM 424020010001 Meccanismo monodisco a 3 leve Ø 180 mm	Art. 15146 	OEM 945215000000 Disco frizione rigido in ferodo - mozzo bombato 180x124x3,5 mm 29x23x4,5 (SAE 1 1/8") - Z.10	Art. 15669 OEM  Reggispinta con battente 30x62x20 mm appoggio piano
					Art. 16046 OEM 4240190  Manicotto con cuscinetto reggispinta 33,5x136x44 mm appoggio piano
910 - 931 - 937 - 940 - 941 - 944 - 945 - 946 - 947 - 946T - 986T - 988T - MD 23 - 24 MOZZO BOMBATO	Art. 15217 	OEM Disco frizione rigido in ferodo 181x124x3,5 mm 29x23x4 mm - Z.10	Art. 16046 	OEM 4240190 Manicotto con cuscinetto reggispinta 33,5x136x44 mm appoggio piano	Art. 15669 OEM  Reggispinta con battente 30x62x20 mm appoggio piano
906 - 910 MOZZO BOMBATO 985 2° Serie (segue PASQUALI)	Art. 15146 	OEM 945215000000 Disco frizione rigido in ferodo - mozzo bombato 180x124x3,5 mm 29x23x4,5 (SAE 1 1/8") - Z.10			







Frizioni e loro componenti

CLUTCHES - CLUTCH DISK - BEARING - COUPLING - LEVER - SET-REVISION















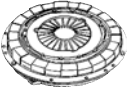







11

11











segue PASQUALI

956 - 957 - 958 - 959 - 970 - 971 - 990 - 991 - 993 995 - 996 - 997 - 988	 Art. 15539	OEM 990.118.0 988.136.0-988.136.1 Frizione monodisco con molle a diaframma Piatto Ø 190 mm	 Art. 15218	OEM 990.123.1 Disco frizione rigido in ferodo 190x131x4 mm 29x23x4 mm - Z.10	 Art. 15669	OEM Reggispinta con battente 30x62x20 mm appoggio piano
	 Art. 15941	OEM 9881361 Meccanismo monodisco a 3 leve Ø 190 mm	 Art. 15798	OEM 990.123.1 Disco frizione rigido in ferodo con parastrappi 190x131x4 mm 29x23x4 mm - Z.10	 Art. 16046	OEM 4240190 Manicotto con cuscinetto reggispinta 33,5x136x44 mm appoggio piano

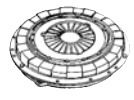



PGS

MOTOCOLIVATORI: ATTILA 11 - SERIE SMERALDO	 Art. 15016	OEM Frizione monodisco a molle elicoidali Piatto Ø 155 mm	 Art. 15034	OEM Disco frizione rigido in ferodo 155x114x4,5 mm 19x16x3 mm - Z.10	 Art. 15048	OEM Manicotto
	 Art. 15051	OEM Cuscinetto reggispinta	 Art. 15059	OEM Leva a forcella		
MOTOCOLIVATORI: F10	 Art. 15007	OEM Meccanismo monodisco a molle elicoidali Piatto Ø 160 mm	 Art. 15040	OEM Disco frizione rigido in ferodo 160x108x3,2 mm 22x19x3,5 mm - Z.10		
MOTOCOLIVATORI: F13 - F14 - F16 - L 15 - ATTILA SUPER DUMPER 2096 3078	 Art. 15296	OEM Frizione monodisco a molle elicoidali Piatto Ø 187 mm	 Art. 15038	OEM Disco frizione rigido in ferodo 184x127x3,8 mm 22x18x3,5 mm - Z.10		
	 Art. 15052	OEM Cuscinetto reggispinta 68x36x19 mm	 Art. 15047	OEM Manicotto		
TRATTORINI: ROMA 38	 Art. 15006	OEM 0703915037 Frizione monodisco con molle elicoidali Piatto 187 mm	 Art. 15038	OEM Disco frizione rigido in ferodo 184x127x3,8 mm 22x18x3,5 mm - Z.10		
	 Art. 15052	OEM 08210 Cuscinetto reggispinta 68x36x19 mm	 Art. 15047	OEM 03018 Manicotto		
TRATTORINI: ROMA 500 - R55 - TRANSPORTER 450	 Art. 15009	OEM 00184 Frizione monodisco con molle elicoidali Piatto 215 mm	 Art. 15027	OEM 02922 Disco frizione rigido in ferodo 216x152x3,5 mm 22x18x3,5 mm - Z.10		
	 Art. 15052	OEM 08210 Cuscinetto reggispinta 68x36x19 mm	 Art. 15047	OEM 03018 Manicotto		
CARRELLO ELEVATORE D200S - D3000S 2500 OVERLAND	 Art. 15345	OEM Meccanismo monodisco a molle elicoidali Piatto Ø 250 mm	 Art. 15234	OEM Disco frizione rigido in ferodo 250 mm 35x29 mm Z.10	 Art. 15365	OEM 541743 Cuscinetto reggispinta
			 Art. 15364	OEM 4561428 Manicotto		







PINZA - GRILLO

MOTAZAPPE: 9000 - 9000R - MOTOCOLTIVATORI: GRILLO GN 10/12	Art. 15354 OEM  Frizione monodisco a molle elicoidali Piatto Ø 140 mm	Art. 15219 OEM 9037 Disco frizione rigido in ferodo 140x96x3,8 mm 16x13x3,5 mm - Z.6	
MOTOCOLTIVATORI: GRILLO (2ª serie)	Art. 15016 OEM 50709  Frizione monodisco a molle elicoidali Piatto Ø 155 mm	Art. 15032 OEM 7052  Disco frizione rigido 155x114x4,5 mm 16x13x3,5 mm - Z.6	
MOTOCOLTIVATORI: GRILLINO 127 - GRILLINO 1100 - MOTOFALCIATRICI: BL / BC	Art. 15001  Frizione conica Ø 103x100 mm Albero Ø 22,5 mm Conicità 1:5 15x12EV - Z.8		
MOTOCOLTIVATORI: 131	Art. 15381 OEM  Frizione monodisco a molle a diaframma Piatto Ø 160 mm	Art. 15220 OEM 13242 Disco frizione rigido in ferodo 160x110x3,8 mm 16x13x3,5 mm - Z.6	
TRATTORE 40 HP	Art. 15010 OEM  Frizione monodisco con molle elicoidali Piatto 215 mm	Art. 15221 OEM Disco frizione rigido in ferodo 216x152x4 mm 22x18x3,5 mm - Z.10	Art. 15052 OEM  Cuscinetto reggispinta 68x36x19 mm
MOTOFALCIATRICI MOTOCOLTIVATORI 130	Art. 15594  Frizione conica Ø 103x98,5 mm Albero Ø 22,5 mm Conicità 1:5 15x12EV - Z.8		
MOTOFALCIATRICI MOTOCOLTIVATORI	Art. 15527  Frizione Ø 103x99 mm a dischi multipli con 5 dischi 15x12EV - Z.8 Albero Ø23 Conicità 1:5	Art. 15584 OEM  Serie dischi completa composta da 5 dischi di Ø 93 mm	

POLENTES

TRATTORINO PIERRE	Art. 15006 OEM  Frizione monodisco a molle elicoidali Piatto Ø 187 mm	Art. 15038 OEM  Disco frizione rigido in ferodo 184x127x3,8 mm 22x18x3,5 mm Z.10	Art. 15047 OEM  Cuscinetto reggispinta
			Art. 15052 OEM  Cuscinetto reggispinta 68x36x19 mm

RANDI

MOTOCOLTIVATORE 2500 - 2500 SUPER - 3000 - 3500 - 4000 - 6000 JUNIOR	Art. 15016 OEM  Frizione monodisco con molle elicoidali Piatto Ø 155 mm	Art. 15025 OEM  Disco frizione rigido in ferodo 160x110x3,8 mm 19x15,5x3 mm Z.10	Art. 15051 OEM  Cuscinetto reggispinta
			Art. 15359 OEM  Manicotto
MOTOCOLTIVATORI 3600 TRATTORINI R421 - R424	Art. 15296  Meccanismo monodisco a molle elicoidali Piatto Ø 184 mm	Art. 15026  Disco frizione rigido 184x127x3,8 mm 19x15,5x3 mm - Z.10	Art. 15052  Cuscinetto reggispinta 68x36x19 mm







Frizioni e loro componenti

CLUTCHES - CLUTCH DISK - BEARING - COUPLING - LEVER - SET-REVISION



11

11







RAPID

MOTOFALCIATRICE ALLTRAC	Art. 15149 	OEM Frizione monodisco a molle elicoidali Piatto Ø 215 mm		
MOTOFALCIATRICE ALLTRAC	Art. 15010 	OEM Frizione monodisco con molle elicoidali Piatto 215 mm		
MOTOCOLTIVATRICE EURO 3	Art. 15321 	OEM Frizione monodisco con molla a diaframma Piatto Ø 95 mm	Art. 15189 	OEM Disco frizione rigido in ferodo 94x61x1,5 mm 15x12EV - Z.8
MOTOCOLTIVATRICE 505	Art. 15733 	OEM Frizione monodisco con molle elicoidali Piatto 160 mm	Art. 15734 	OEM 44218 Disco PTO rigido in ferodo Ø 160 mm 20x18EV - Z.18

























ROTECO

MOTAZAPPA	Art. 15735 	OEM Frizione conica Ø 103x94,5 mm Albero Ø 23 mm Conicità 1:5 15x12 mm - Z.8		
MOTOCOLTIVATORE 10/14 HP	Art. 15013 	OEM Frizione monodisco con molle a diaframma Piatto 160 mm	Art. 15198 	OEM Disco frizione rigido 155x110x4 mm 17x15 ASA 32/64 Z.20





RENAULT (CLAAS)

CERES 75/X - 95X - 320/X - 325/X - 335/X - 340/X - 345/X ERGOS 95 - 105	Art. Kit 16049 			OEM Kit composto da: - Meccanismo 15919 - Disco PTO 15920
	Art. 15919 	OEM 7700062285 7700058654 Meccanismo a 6 leve Ø 310 mm con disco interno 40x45 mm - Z.16	Art. 15920 	OEM 7700060873 Disco PTO Ø 310 mm 21,7x25 mm - Z.13
		Art. 62580 	OEM 7700620323 Cuscinetto 17x40x12 mm	Art. 15756 
		Art. FAG 63866		OEM 7700069705 - 7700515751 - 7700653344 Cuscinetto reggispinta 96,5x65x23,5 mm
				OEM 7700069706 - 7700653343 Cuscinetto reggispinta PTO 106x139,5x25 mm

segue RENAULT (CLAAS)

CERES 320/X - 325/X - 335/X - 340/X - 345/X CERGOS 330 - 335	Art. 15919  LUK	OEM 7700062285 7700058654 Meccanismo a 6 leve Ø 310 mm con disco interno 40x45 mm - Z.16	Art. 15925  LUK	OEM 7700052919 Disco PTO a 4 pale Ø 280 mm 21x25 mm - Z.13	Art. 15755 	OEM 7700069705 - 7700515751 - 7700653344 Cuscinetto reggispinta 96,5x65x23,5 mm
			Art. 62580  LUK	OEM 7700620323 Cuscinetto 17x40x12 mm	Art. FAG 63866	Art. 15756 
CERGOS 350 CERGOS 355	Art. Kit 16074  LUK	 LUK	 LUK	OEM 6005705428 Kit composto da: - Meccanismo 15944 - Disco PTO 15920		
	Art. 15944  LUK	OEM 7700060339 - 0011309880 Meccanismo a 6 leve Ø 330 mm con disco interno 40x45 mm - Z.16 - 5 pale	Art. 15920  LUK	OEM 7700060873 Disco PTO Ø 310 mm 21,7x25 mm - Z.13	Art. 15755 	OEM 7700069705 - 7700515751 - 7700653344 Cuscinetto reggispinta 96,5x65x23,5 mm
					Art. 15756 	OEM 7700069706 - 7700653343 Cuscinetto reggis. PTO 106x139,5x25 mm
DIONIS 110-140 FRUCTUS 120-140 HERDSMAN 80-140- 210-230-240 PALES 210-230-240	Art. Kit 16054  LUK	 LUK	 LUK	 LUK	 LUK	 LUK
	Art. 15946  LUK	OEM 6000105184 Meccanismo a 6 leve completo di disco centrale metalceramico 34x40 mm - Z12 senza disco PTO Piatto Ø 280 (11") intercambiabile con OMG	Art. 15873  LUK	OEM 6000105768 Disco PTO rigido in metalceramico. Ø 280 mm 22x19 mm - Z13	Art. 15948  LUK	OEM Disco PTO rigido in ferodo. Ø 280 mm 22x19 mm - Z13
	Art. 15280  LUK	OEM Cuscinetto reggispinta cambio 90x50x22 mm	Art. LUK 15990	Art. 63363  LUK	OEM Cuscinetto PTO 100x65x18 mm	Art. FAG 63895
				Art. FAG 64536 	OEM Cuscinetto volano 40x12x17 mm	

SAME RUOTE

CENTAUTO 55-60-65 CORSARO 70 CORSARO 70 SYNCRO	Art. 15228  LUK	OEM 157.2213.3/10 Disco frizione in ferodo rigido 290x160x3,8 mm 29x23x4 mm - Z.10	Art. 15438  LUK	OEM 135.2222.3/10 Disco PTO rigido in ferodo 255x155x3,5 mm 45x41EV - Z.22	Art. 15799 	OEM 2.2999.003.0 Cuscinetto reggispinta 65x102x26 mm
ITALIA 35 doppia frizione	Art. 15223  LUK	OEM 144.2213.3/03 Disco frizione avanzamento rigido in ferodo 225x130x4,5 mm 29x23x4 mm - Z.10				
PULEDRO U - DT (segue SAME RUOTE)	Art. 15222  LUK	OEM001.6058.3 Disco PTO rigido in ferodo 262x195x4,5 mm 29x23x4 mm - Z.10				



























Frizioni e loro componenti

CLUTCHES - CLUTCH DISK - BEARING - COUPLING - LEVER - SET-REVISION







































11

11

segue SAME RUOTE

CENTURION 75 EXPORT MERCURY 85 EXPORT MERCURY 85 SPECIAL SATURNO 80 SYNCRO	Art. 15229  OEM 180.2213.3/10 Disco centrale in ferodo con molle parastrappi 320x203x3,8 mm 29x23x4 mm - Z.10	Art. 15447  OEM 136.2222.3/10 Disco PTO rigido in ferodo 265x155x3,5 mm 45x41EV - Z.22	Art. 15799  OEM 2.2999.003.0 Cuscinetto reggispinta 65x102x26 mm
SIRENETTA SIRENETTA 35	Art. 15224  OEM 150.2213.3 - 0.008.4806.3 - 0.015.6384.3 Disco PTO rigido in ferodo 212x152x4 mm 23x18x3 mm - Z.10		
DELFINO 32 - 35 - VIGNERON 35 - 45 doppia frizione	Art. 15224  OEM 150.2213.3 - 0.008.4806.3 - 0.015.6384.3 Disco rigido in ferodo 212x152x4 mm 23x18x3 mm - Z.10	Art. 15918  OEM 150.2222.3 - 0.015.6383.3 Disco PTO per frizione doppia Ø 200 38x34 mm - Z.19	
AURORA 35 - 45 RANGER 45 VIGNERON 50	Art. 15912  OEM 151.2222.3 0.015.6382.3 0.008.4803.3 Disco frizione rigido interno organico Ø 230 40x35 mm - Z.14	Art. 15913  OEM 151.2213.3 0.014.9429.3 0.008.4804.3 Disco lato cambio esterno Ø 250 mm 25x20x4 mm - Z.10	Art. 15742  OEM 2.2999.034.0 0.192.6550.3 Cuscinetto reggispinta cambio - 92x55x27mm
MINITAURO 60 FRUTTETO MINITAURO 60 VIGNETO MINITAURUS 60 FRUTTETO MINITAURUS 60 SYNCRO CONDOR 55 CORSARO 70 - TAURUS 60 FALCON 50 VIGNEROM 60 - 75 FRUTTETO1 60 - 75 N.B.: per applicabilità contattare assistenza tecnica con numero telaio trattore.	Art. Kit 16070    OEM 0.194.2210.4/20 Kit composto da: - Meccanismo 15805 - Disco 15986		
	Art. 15805  OEM 0.194.2210.4/20 Meccanismo a 6 leve completo di disco PTO senza disco centrale Ø 280 mm - Z.20	Art. 15986  OEM 003.8404.3 0.194.2213.3/10 0.015.6391.3 Disco in ferodo con molle parastrappi lato volano 280x165x3,5 mm 25x22EV - Z.14	Art. 15227  OEM 003.8404.3 0.194.2213.3/10 0.015.6391.3 Disco in ferodo con molle parastrappi lato volano 280x165x3,5 mm 25x22EV - Z.14
		Art. 15446  OEM 194.2222.3/10 Disco PTO rigido in ferodo 250x165x3,5 mm 40x36EV - Z.20	Art. 15799  OEM 2.2999.003.0 Cuscinetto reggispinta 65x102x26 mm
TIGER SIX 105 (dal telaio 7129 in avanti) LEOPARD 90 TURBO JAGUAR 100 - LASER 90 - 100 - 110	Art. Kit 15394    OEM 212.2358.4/10 0.014.0175.4 KIT meccanismo di movimento con disco. Piatto Ø 350 mm		
	Art. 15445  OEM 0.269.2313.3/10 Disco centrale rigido in ferodo 352x195x4,3 mm 50x45EV - Z.24	Art. 15293  OEM 212.2359.3/10 0.014.0176.3 Disco centrale metalcer. a 7 pale Rigido Ø 350 mm sinterizzato 50x45EV - Z.24	Art. 16043  OEM 0.264.6533.3/20 Manicotto con cuscinetto 65x74x215 mm
			Art. 15442  OEM 0.202.6551.3/20 Manicotto con cuscinetto reggispinta 65x74x225 mm
JAGUAR 95-100 LEOPARD 85-90-90T (segue SAME RUOTE)	Art. Kit 16107    OEM 0.015.6389.4 0.176.2351.4/10 KIT meccanismo con disco Ø 330 mm		

segue SAME RUOTE

DORADO 55-60-65 EXPLORER 60-65/SPECIAL 70-80/SPECIAL EXPLORER II 60/ SPECIAL - 70/SPECIAL GOLDEN 60-65 SAME 65 TAURUS - 100E TIGER 105 SYNCRO	Art. Kit 16038    	OEM 0.015.9287.3				
	Art. 15439  	Art. 15439 OEM 0.015.9287.3 255.2320.3/10 0.009.6914.3/20 Meccanismo con molle a diaframma Piatto Ø 280 mm	Art. 15979  	Art. 15979 OEM 0.015.9286.3 Disco frizione centrale in ferodo con molle parastrappi 280x172x3,5 mm 40x36,5EV - Z.24	Art. 15440 	Art. 15440 OEM 0.015.9286.3 0.009.6913.3/10 255.2330.3/20 270.2330.3/10 Disco frizione centrale in ferodo con molle parastrappi 280x172x3,5 40x36,5EV - Z.24
					Art. 15744 	Art. 15744 OEM 2.2999.475.0 Cuscinetto reggispinta 90x55x22 mm
ANTARES 100-110-130 EXPLORER 80 SPECIAL/SPECIAL LT EXPLORER 90LP/ SPECIAL/SPECIAL LP EXPLORER 100 LP EXPLORER II 80/80LP/ SPECIAL LP/90T LASER 170 ROW CROP 90 SILVER 80-85-90-95- 100.4-100.6-105-110- 130	Art. 15647  	Art. 15647 OEM 0.008.4184.3 0.014.9423.3/10 Meccanismo con molle a diaframma Piatto Ø 330 mm	Art. 15964  	Art. 15964 OEM 008.9937.3 Disco centrale in ferodo con molle parastrappi 330x196x4,2 mm 41x36,5EV - Z.24	Art. 15803 	Art. 15803 OEM 008.9937.3 Disco centrale in ferodo con molle parastrappi 330x196x4,2 mm 41x36,5EV - Z.24
	Art. 15965   Per gli altri modelli	Art. 15965 OEM 0.014.9432.3 Disco centrale metalceramico a 6 p. con molle parastrappi Ø330 mm sinterizzato 41x45,3 mm - Z.21	Art. 15749  Per gli altri modelli	Art. 15749 OEM 0.014.9432.3 Disco centrale metalceramico a 6 p. con molle parastrappi Ø330 mm sinterizzato 41x45,3 mm - Z.21	Art. 15895   Per SILVER 80-85-90-95-100.4-100.6-105-110	Art. 15895 OEM 007.7928.3 Disco centrale organico con molle Ø 310 mm 41x36,5EV - Z.24
	Art. 15984  	Art. 15984 OEM 0.016.6105.3 Disco PTO 6 pale Ø 330 mm 36x40 mm - Z24	Art. 15673  Per SILVER 100.6 e ANTERS 100	Art. 15673 OEM 009.6533.3 Disco centrale metalceramico a 6 pale con molle parastrappi Ø 330 mm sinterizzato 41x36,5EV - Z.24	Art. 15744 	Art. 15744 OEM 2.2999.475.0 Cuscinetto reggispinta 90x55x22 mm
					Art. 15883 	Art. 15883 OEM 2.2999.510.0 2.2999.207.0 2.2999.443.0 112x65x42 mm Cuscinetto reggispinta
EXPLORER 80 - 90 SILVER 80-90-100.4	Art. 15647  	Art. 15647 OEM 0.008.4184.3 0.014.9423.3 Meccanismo con molle a diaframma Piatto Ø 330 mm	Art. 15964  	Art. 15964 OEM 008.9937.3 Disco centrale in ferodo con molle parastrappi 330x196x4,2 mm 41x36,5EV - Z.24	Art. 15803 	Art. 15803 OEM 008.9937.3 Disco centrale in ferodo con molle parastrappi 330x196x4,2 mm 41x36,5EV - Z.24
	Art. 15965  	Art. 15965 OEM 0.014.9432.3 Disco centrale metalceramico a 6 p. con molle parastrappi Ø330 sinterizzato 41x45,3 mm - Z.21	Art. 15749  	Art. 15749 OEM 0.014.9432.3 Disco centrale metalceramico a 6 p. con molle parastrappi Ø330 sinterizzato 41x45,3 mm - Z.21	Art. 15984  	Art. 15984 OEM 0.016.6105.3 Disco PTO 6 pale Ø 330 36x40 - Z24
	Art. 15883 	Art. 15883 OEM 2.2999.510.0 2.2999.207.0 2.2999.443.0 112x65x42 mm Cuscinetto reggispinta	Art. 15744 	Art. 15744 OEM 2.2999.475.0 Cuscinetto reggispinta 90x55x22 mm		

(segue SAME RUOTE)





























Frizioni e loro componenti

CLUTCHES - CLUTCH DISK - BEARING - COUPLING - LEVER - SET-REVISION

11







































11

segue SAME RUOTE

LASER 115 - 130 - 140 - 150 - 160 - 170	Art. Kit 16233  	OEM 9.P023.00.9		
	Kit Frizione mono disco con cuscinetto reggispinta. Ø 350 mm.			
	Art. 16234  OEM 0.015.7949.3 0.015.7949.3/10 Disco frizione a 7 pale Ø 350 mm - Z.24	Art. 15883  OEM 2.2999.510.0 2.2999.207.0 2.2999.443.0 112x65x42 mm Cuscinetto reggispinta		
LASER 130 - 150 - LASER 165 TURBO TRIDENT 130 EXPORT	Art. Kit 15394  	Art. 15293  OEM 212.2359.3/10 Disco centrale metalceramico a 7 pale Rigido Ø 350 mm sinterizzato 50x45EV - Z.24		
	Art. 15442  OEM 0.202.6551.3/20 Manicotto con cuscinetto reggispinta per TRIDENT130 e EXPORT 65x74x225 mm	Art. 16043  OEM 0.264.6533.3/20 Manicotto con cuscinetto x LASER 65x74x215 mm	Art. 15883  OEM 2.2999.510.0 2.2999.207.0 2.2999.443.0 112x65x42 mm Cuscinetto reggispinta	
DORADO70/75/80 EXPLORER 70-75-80- 85-90 EXPLORER II 70 SPECIAL/SPECIAL BASSO EXPLORER 75 SPECIAL EXPLORER II 80/LO/ SPECIAL BASSO/ SPECIAL LP EXPLORER 90T GOLDEN 75-85	Art. 15746  OEM 0.015.9285.3 0.008.4254.3/10 Meccanismo con molla a diaframma piatto Ø 310 mm	Art. 15963  OEM 44623.303 0.455.2330.3/10 0.015.9288.3 Disco centrale in ferodo con molle parastrappi 310x191x3,5 mm 40x36,5 mm - Z.24	Art. 15441  OEM44623.303 0.455.2330.3/10 0.015.9288.3 Disco centrale in ferodo con molle parastrappi 310x191x3,5 mm 40x36,5 mm - Z.24	
	Art. 15962  OEM 0.015.9289.3 0.014.1111.3 Disco centrale metaceramico 6 pale con parastrappi Ø310 mm sinterizzato 41x36 mm - Z.24	Art. 15748  OEM 0.015.9289.3 0.014.1111.3 Disco centrale metaceramico 6 pale con parastrappi Ø310 mm sinterizzato 40x36,5 mm - Z.24	Art. 16011  OEM Disco centrale in ferodo 310x190x3,5 mm 40x36 mm - Z.24	
	Art. 15744  OEM 2.2999.475.0 Cuscinetto reggispinta cambio 90x55x22 mm			
ANTARES 110 II EXPLORER 80 II - 80SP/LP - 90 II - 90SP/ LP ROW CROP 100.6 SILVER 80 - 90 - 100.4 - 100.6 - 110	Art. 15954  OEM 0.010.6912.3/10 0.015.6386.3 Meccanismo con molle a diaframma Piatto Ø 350 mm	Art. 15953  OEM 0.007.7929.3/10 0.015.6328.3 Disco Ø 350 mm 36,5x41 mm - Z.24	Art. 15983  OEM 0.007.7930.3/10 Disco Ø 350 mm 41x45 mm - Z.21	
		Art. 16010  OEM 0.015.6381.3 Disco Ø 330 mm 36,5x41 mm - Z.24	Art. 15744  OEM 2.2999.475.0 Cuscinetto reggispinta 90x55x22 mm	
DORADO 70-75-85 EXPLORER 70N/SPECIAL - 75N/SPECIAL - 80 - 85 - 90 EXPLORER II 70N/SPECIAL/SPECIAL BASSO 80/LP/SPECIAL LP/ SPECIAL BASSO 90 TURBO GOLDEN 75-85	Art. 15420  OEM 0.014.9424.3 0.008.4293.3 Meccanismo con molle a diaframma Piatto Ø 310 mm	Art. 15982  OEM 0.015.9289.3 0.014.1111.3 Disco centrale metaceramico 6 pale con parastrappi Ø310 mm sinterizzato 41x36 mm - Z.24	Art. 15748  OEM 0.015.9289.3 0.014.1111.3 Disco centrale metaceramico 6 pale con parastrappi Ø310 mm sinterizzato 40x36,5 mm - Z.24	
	Art. 15895  OEM 007.7928.3 Disco centrale metaceramico 6 pale con parastrappi Ø310 mm sinterizzato 41x36,5 mm - Z.24	Art. 15441  OEM 44623.303 0.455.2330.3/10 0.015.9288.3 0.009.69.24 Disco centrale in ferodo con molle parastrappi 310x191x3,5 mm 40x36,5 mm - Z.24	Art. 15744  OEM 2.2999.475.0 Cuscinetto reggispinta 90x55x22 mm	

(segue SAME RUOTE)

segue SAME RUOTE

DORADO 70 - 76 - 85 - 86 - 90 - 90.4 - F70 - F75 - F90 - F100 - S70 - S75 - S90 - S100 DORADO ³ 70 - 80 - 90 EXPLORER 80 - 85 - 90 - 90.4 EXPLORER II EXPLORER SPECIAL EXPLORER T-TB EXPLORER ³ FRUTTETO S/V FRUTTETO ³ S/V KRYPTON VIRTUS	Art. Kit 16055  	 	OEM Kit composto da: - Meccanismo 15960 - Disco 15961 - Cuscinetto 15744
	Art. 15960  	OEM 0.014.9017.3 Meccanismo frizione con molle a diaframma Ø 310 mm	Art. 15961  
ANTARES II 110 EXPLORER 75 - 80 SPECIAL - 85 T/TB - 90 SPECIAL - 95T/TB EXPLORER II 85 SPECIAL - 90T - 95 SPECIAL ROW CROP 90 - 100 SILVER 80 - 85 - 90 - 95 - 100.4 - 100.6 - 105 - 110	Art. Kit 16141  	 	OEM 001661063 Kit composto da: - Meccanismo 15985 - Disco PTO 15984 - Cuscinetto 15744
	Art. 15985  	OEM 0.016.6106.3 Meccanismo frizione con molle a diaframma Ø 350 mm	Art. 15984  
ANTARES II 130	Art. Kit 16042  	 	OEM Kit composto da: - Meccanismo 15881 - Disco PTO 15882 - Cuscinetto 15883
	Art. Kit 16039  		OEM Kit composto da: - Meccanismo 15881 - Disco PTO 15882
	Art. 15881  	OEM 0.008.5595.3 Meccanismo frizione con molle a diaframma Ø 350 mm	Art. 15882  
EXPLORER 55-60-65-70 SAME 65		Art. 15979  	OEM 0.015.9286.3 Disco frizione centrale in ferodo con molle parastrappi 280x172x3,5 mm 40x36,5EV - Z.24
KRIPTON 100 90-100 95-105 SILVER 95-105-110	Art. Kit 16041  	 	OEM 0.012.2621.4 Kit composto da: - Meccanismo 15923 - Disco centrale 15924 - Cuscinetto 15744
	Art. 15923  	OEM 0.012.7094.3 Meccanismo frizione con molle a diaframma Ø 330 mm (13")	Art. 15924  
(segue SAME RUOTE)			Art. 15744  

































Frizioni e loro componenti

CLUTCHES - CLUTCH DISK - BEARING - COUPLING - LEVER - SET-REVISION

11







































11

segue SAME RUOTE

GALAXY 170 HERCULES 160 - LASER 150 TITAN	Art. Kit 15394    OEM 212.2358.4/10 0.014.0175.4 KIT meccanismo di movimento con disco. Piatto Ø 350 mm		
	Art. 15293   OEM Disco centrale metalceramico a 7 pale Rigido Ø 350 mm sinterizzato 50x45EV - Z.24	Art. 16043   OEM 0.264.6533.3/20 Manicotto con cuscinetto 65x74x215 mm	Art. 15442   OEM 0.202.6551.3/20 Manicotto con cuscinetto reggispinta 65x74x225 mm
	Art. 15883   OEM 2.2999.510.0 2.2999.207.0 2.2999.443.0 112x65x42 mm Cuscinetto reggispinta		
ARGON 60/70/55/65F	Art. 15745   OEM 0.012.2574.4 - 0.012.2571.4 Meccanismo 6 leve completo di disco centrale sinterizzato 40x36 - Z.20 Piatto Ø 280 mm	Art. 15917   OEM 0.011.9067.3 Disco Ø 280 mm 22x25 mm - 14 cave	Art. 15121   OEM 0.014.9428.3 Disco PTO rigido in ferodo 280x165x3,5 mm 25x22 mm - Z.14
	Art. 62549   Art. FAG 63836 OEM Cuscinetto volano 20x47x14 mm	Art. 15990   OEM 2.2999.153/10 Cuscinetto reggispinta cambio 90x50x22 mm	Art. 15280   OEM 2.2999.153/10 Cuscinetto reggispinta cambio 90x50x22 mm
			Art. 63363   Art. FAG 63895 OEM 2.2021.017.0 Cuscinetto PTO 100x65x18 mm
ARGON 55-60-65F SOLAR 60	Art. 15916   OEM 0.012.2567.4 0.019.8634.4 Meccanismo a 6 leve completo di disco Ø 280 mm	Art. 15917   OEM 0.011.9067.3 Disco Ø 280 mm 22x25 mm - 14 cave	Art. 15990   OEM 2.2999.153/10 Cuscinetto reggispinta cambio 90x50x22 mm
			Art. 15280   OEM 2.2999.153.0/10 Cuscinetto reggispinta cambio 90x50x22 mm

(segue SAME RUOTE)

segue SAME RUOTE

SOLAR 50 CV ARGON 50	Art. Kit 16044      	OEM 0.012.2563.4		
	Art. 15395  	OEM 463.2411.4 - 0.012.2563.4 Meccanismo a 6 leve completo di disco centrale in ferodo senza il disco PTO Piatto Ø 250 mm (11")	Art. 15804  	OEM 0.011.9063.3 Disco PTO rigido in ferodo 225x145x3,5 mm 25x22EV - Z.14
	Art. 15402 	OEM 254.2213.3 - 463.2413.3 Disco centrale rigido in ferodo 250x155x3,5 mm 40x36EV - Z.20	Art. 15990  	OEM 2.2999.153/10 Cuscinetto reggispinta cambio 90x50x22 mm
			Art. 15280 	OEM 2.2999.153.0/10 Cuscinetto reggispinta cambio 90x50x22 mm
		Art. 62951 	OEM 2.2021.018.0 Cuscinetto reggispinta PTO 70x110x20 mm	
		Art. FAG 63896 	OEM Cuscinetto volano 20x47x14 mm	
		Art. FAG 63836 		
ASTER 60-70 - FRUTTETO II 65/75/85/90/100 ROCK 55/N/M/C - ROCK 60N/M/C/SC - ROCK 70N/M/C SOLAR 55C-60-60C - VIGNERON 62-75	Art. Kit 15959      	OEM Kit composto da: - Meccanismo 15745 - Disco 15917 - Cuscinetti 15990 - 63896 - 63836		
	Art. 15745  	OEM 0.012.2574.4 - 0.012.2571.4 - 0.020.3543.4 Meccanismo 6 leve completo di disco centrale sinterizzato 40x36 - Z.20 Piatto Ø 280 mm	Art. 15917  	OEM 0.011.9067.3 Disco Ø 280 mm 22x25 mm - 14 cave
	Art. 62549 	OEM Cuscinetto volano 20x47x14 mm	Art. 15990  	OEM 2.2999.153/10 Cuscinetto reggispinta cambio 90x50x22 mm
			Art. 63363 	OEM 2.2021.017.0 Cuscinetto PTO 100x65x18 mm
		Art. FAG 63895 	Solo per modelli ARGON.	
		Art. FAG 63896 		
ARGON 65/70/75 DORADO 50/55/65/75 DORADO NATURAL 50/55/65/70 FRUTTETO NATURAL 60/65/70/75 TREM II 60/603 TIGER 60/60E/65 /70/70E/75 TIGER COMPACT 46/ 50/55/60	Art. Kit 16218      	OEM 9.J1424.00.9 - 0.015.4708.3/10		
	(segue SAME RUOTE)	Kit Frizione con meccanismo a 6 leve disco e cuscinetti. Piatto Ø 280 mm.		





























Frizioni e loro componenti

CLUTCHES - CLUTCH DISK - BEARING - COUPLING - LEVER - SET-REVISION











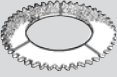



11

11

segue SAME RUOTE

SOLARIS 30 - 35 - 40 - 45 - 50 - 55	Art. Kit 15987   		OEM 0.012.5851.4/20 Kit frizione doppia a 6 leve con disco interno Ø 230 mm			
		Art. 62952 	OEM Cuscinetto reggispinta PTO 75x115x20 mm Art. FAG 63897	Art. 62577 	OEM Cuscinetto volano 15x35x11 mm Art. FAG 63863	
ARGON 75/80/90/100 DORADO 75/80/85/90/100 EXPLORER 75/80 TIGER 75/80	Art. Kit 16276      		OEM 0.017.7890.4 Kit Frizione con meccanismo a 6 leve disco e cuscinetti. Piatto Ø 310 mm.			
	Art. 15990 	OEM Cuscinetto reggispinta cambio 90x50x22 mm	Art. 63363 	OEM Cuscinetto PTO 100x65x18 mm Art. FAG 63895	Art. 62549 	OEM Cuscinetto volano 20x47x14 mm Art. FAG 63836
SOLARIS 25 - 35 Frizione doppia	Art. 15706 	OEM 0.010.0288.4 Meccanismo a 3 leve completo di disco centrale in ferodo senza il disco PTO Piatto Ø 184 mm	Art. 15707 	OEM Disco PTO in ferodo 184x127x3,8 mm 20x17 mm Z.12	Art. 15272 	OEM 0.010.8739.3 Cuscinetto reggispinta piccolo 82x50x28
					Art. 15808 	OEM 0.010.8738.3 Cuscinetto reggispinta grande 117x75x27
SOLARIS 35 - 45 Frizione doppia	Art. 15704 	OEM 0.009.6395.4/10 Meccanismo a 3 leve completo di disco centrale in ferodo senza il disco PTO Piatto Ø 215 mm	Art. 15705 	OEM 0.009.6437.3 Disco PTO rigido in ferodo 216x152x3,8 mm 20x17 mm - Z.12	Art. 15272 	OEM 0.010.8739.3 Cuscinetto reggispinta piccolo 82x50x28
					Art. 15808 	OEM 0.010.8738.3 Cuscinetto reggispinta grande 117x75x27
KRYPTON F100 - F90 - J90	Art. Kit 16055    		OEM Kit composto da: - Meccanismo 15960 - Disco 15961 - Cuscinetto 15744			
	Art. 15960 	OEM Meccanismo frizione con molle a diaframma Ø 310 mm	Art. 15961 	OEM Disco Ø 310 mm	Art. 15744 	OEM Cuscinetto reggispinta 90x55x22 mm

SAME CINGOLI

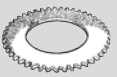
CONDOR C	Art. 15173  OEM 168.2314.0 Anello per frizione centrale dentatura est. 277x156x10 mm (1/3T) 45 denti	Art. 15388  OEM 160.6525.0 Anello per frizione cambio 88x48x4,5 mm 8 fori	Art. 15417  OEM 434.5714.0/10 Anello per frizione di sterzo dentatura esterna 219,2x152x4,7 mm 71 denti
FALCON C	Art. 15173  OEM 168.2314.0 Anello per frizione centrale - dent. esterna 277x156x10 mm (1/3T) 45 denti	Art. 15176  OEM 160.5714.0/10 Anello di sterzo - in tessuto - dentatura est. 239x180x4,8 - 28 denti	
	Art. 15389  OEM 160.5715.0 Anello per frizione di sterzo - dentatura interna 229x171x2 - 21 denti	Art. 15417  OEM 434.5714.0/10 Anello per frizione di sterzo - dent. esterna 219,2x152x4,7 - 71 denti	
FOX 35 - 45 - 55 - LEOPARD C	Art. 15417  OEM 434.5714.0/10 Anello per friz. sterzo - dentatura esterna 219,2x152x4,7 mm 71 denti		
MINITAURUS 60C - TAURUS C	Art. 15177  OEM 160.2214.0 Anello per frizione centrale - dentatura est. 277x166x7 - 45 denti	Art. 15388  OEM 160.6525.0 Anello per frizione cambio 88x48x4,5 mm - 8 fori	Art. 15389  OEM 160.5715.0 Anello per frizione di sterzo - dentatura interna 229x171x2 - 21 denti
		Art. 15176  OEM 160.5714.0/10 Anello di sterzo - in tessuto - dentatura esterna 239x180x4,8 - 28 denti	
SOLAR 55C COMPACT - SOLAR 60C ERGOMATIC	Art. 15397  OEM 422.2261.3 Disco frizione centrale rigido in ferodo 280x165x3,8 mm 40x36EV - Z.20	Art. 15121  OEM 422.2222.3/20 Disco PTO rigido in ferodo 280x165x3,5 mm 25x22EV - Z.14	Art. 15389  OEM 160.5715.0 Anello per frizione di sterzo - dentatura interna 229x171x2 - 21 denti
	Art. 15176  OEM 160.5714.0/10 Anello di sterzo - in tessuto - dentatura esterna 239x180x4,8 - 28 denti		

Frizioni e loro componenti

CLUTCHES - CLUTCH DISK - BEARING - COUPLING - LEVER - SET-REVISION































































11

11

SEP

MOTOFALCIATRICE 150 - 200	Art. 15019 	OEM Disco frizione rigido 110x58x1,5 mm 15x12EV - Z.8		
MOTOZAPPA 140	Art. 15608 	OEM Disco frizione rigido 122x80x11,5 mm 28x25EV - Z.15		
MOTOCOLTIVATORI MOTOZAPPE	Art. 15736 	OEM 210962 Disco frizione rigido 82x58x2 mm 28x25EV - Z.15		
MOTOCOLTIVATORE 125	Art. 15737 	OEM 220534 Frizione Ø 100x88 a dischi multipli con 4 dischi Albero 23 mm Conicità 1:5 15x12 - Z.8	Art. 15630 	OEM Disco frizione sinterizzato Ø 93 mm
MOTOCOLTIVATORE 1700	Art. 15743 	OEM 220585 Frizione Ø 103x122 a dischi multipli con 4 dischi. Albero 23 mm Conicità 1:5 15x12 mm - Z.8		
MOTOCOLTIVATORE REVERSIBILE 1000	Art. 15853 	OEM Frizione Ø 100x108 mm a 4 dischi 12x15EV - Z.8 Albero Ø 23 mm	Art. 15630 	OEM Disco frizione sinterizzato Ø 93 mm
MOTOCOLTIVATORE 1700 (motore Robin)	Art. 15854 	OEM Frizione Ø 103x102 mm a 4 dischi 12x15EV - Z.8 Albero Ø 23 mm		
MOTOCOLTIVATORE 1900	Art. 15856 	OEM Frizione Ø 103x107 mm a 4 dischi 12x15EV - Z.8 Albero Ø 24 mm		
MOTOCOLTIVATORE (motore HONDA)	Art. 15857 	OEM 220541 Frizione Ø 100x117 mm a 3 dischi 12x15EV - Z.8 Albero Ø 19,05 mm		
MOTOZAPPA 138 CL	Art. 15858 	OEM Frizione monodisco Ø 142x105 mm 13x16 mm - Z.6 Albero Ø 24 mm		
MOTOZAPPA S 130-132	Art. 15859 	OEM Frizione monodisco Ø 142x87 mm 13x16 mm - Z.6 Albero Ø 23 mm		
MOTOZAPPA S 140	Art. 15860 	OEM Frizione monodisco Ø 142x121 mm 13x16 mm - Z.6 Albero Ø 24 mm		

STEYR

4065 4075	Art. Kit 16073     	OEM 47134886 Kit composto da: - Meccanismo 15797 - Disco PTO 15792 - Cuscinetti 63897 - 63867		
	Art. 15797   OEM 5186548 - 5186550 - 47134884 - 5196770 - 47134873 - 87732485 - 47134886 Meccanismo Piatto Ø 280 mm	Art. 15792   OEM 5176450 - 47134874 - 5196819 Disco PTO rigido in cerametallico 4 pale Ø 280 mm - 22x25 Z10	Art. 62581   OEM 28043280 Cuscinetto volano 17x47x14 mm	Art. FAG 63867  
			Art. 62952   OEM 47127081 Cuscinetto reggispinta PTO 75x115x20 mm	Art. FAG 63897  
KOMPAKT 370/375/ 485/495/4065/4075/ 4085/4095	Art. Kit 16036      	OEM Kit composto da: - Meccanismo 15796 - Disco PTO 15792 - Cuscinetti 15990 - 63897 - 63867		
	Art. Kit 15930   	OEM Kit composto da: - Meccanismo 15796 - Disco PTO 15792		
	Art. 15796   OEM 87732504 5181421 - 5196813 - 47134895 - 87732503 - 87732506 Meccanismo a 6 leve completo di disco centrale cerametallico 6 pale Piatto Ø 280 mm 35x39,8 mm - Z.14	Art. 15990   OEM 5119290 5119875 - 5122028 Cuscinetto reggispinta cambio 90x50x22 mm	Art. 15280   OEM 5122028 87345759 Cuscinetto reggispinta cambio 90x50x22 mm	
	Art. 15792   OEM 5176450 - 47134874 - 5196819 Disco PTO rigido in cerametallico 4 pale Ø 280 mm - 22x25 Z10	Art. 62952   OEM 47127081 Cuscinetto reggispinta PTO 75x115x20 mm	Art. 62581   OEM 28043280 Cuscinetto volano 17x47x14 mm	Art. FAG 63897  
			Art. FAG 63867  	
9155	Art. Kit 15904   	OEM 49700160901 Meccanismo bi-disco Ø 310 mm		
KOMPAKT 360	Art. Kit 16035      	OEM 73328271 Kit composto da: - Meccanismo 15793 - Disco PTO 15792 - Cuscinetti 15990 - 63897 - 63867		
	Art. 15793   OEM 5196818-47134898 Meccanismo a 6 leve completo di disco centrale cerametallico 5 pale Piatto Ø 280 mm	Art. 15792   OEM 5176450 - 47134874 - 5196819 Disco PTO rigido in cerametallico 4 pale Ø 280 mm - 22x25 Z10	Art. 15990   OEM 5119290 5119875 - 5122028 Cuscinetto reggispinta cambio 90x50x22 mm	
		Art. 62952   OEM 47127081 Cuscinetto reggispinta PTO 75x115x20 mm	Art. 62581   OEM 28043280 Cuscinetto volano 17x47x14 mm	Art. FAG 63867  





















Frizioni e loro componenti

CLUTCHES - CLUTCH DISK - BEARING - COUPLING - LEVER - SET-REVISION

11

11

























UNIVERSAL / UTB

<p>453 703 704 723 853</p>	<p>Art. Kit 15929</p>   	<p>OEM</p> <p>Kit composto da: - Meccanismo 15505 - Disco PTO 15943</p>	
<p>MECCANISMO RINFORZATO</p> <p>N.B.: Quando si sostituisce un meccanismo non rinforzato con un meccanismo rinforzato, bisogna sostituire anche il disco PTO.</p>	<p>Art. Kit 15938</p>      	<p>OEM</p> <p>Kit composto da: - Meccanismo 15505 - Disco PTO 15943 - Cuscinetti 15990 - 63896 - 63867</p>	
<p>Art. 15505</p> 	<p>Art. 15943</p> 	<p>Art. 15520</p> 	
<p>Art. 15414</p> 	<p>Art. 15528</p> 	<p>Art. 15523</p> 	
<p>Tipo SILA intercambiabile con LUK</p>	<p>Art. 15990</p> 	<p>Art. 15280</p> 	<p>Art. 62581</p> 
<p>Art. 15863</p> 	<p>Art. 15800</p>	<p>Art. FAG 63867</p>	
<p>Art. 15862</p> 	<p>Art. 15751</p> 	<p>Art. FAG 63896</p>	

URSUS

<p>8054 - 8064STD 9054 C380M - C382 - C392</p>	<p>Art. Kit 16095</p>   	<p>OEM</p> <p>Kit frizione con disco PTO rigido Ø 310 mm Z.13</p>
<p>10014H - 8014H - 9014H</p>	<p>Art. Kit 16092</p>      	<p>OEM 82224600 - 82224610</p> <p>Kit frizione completo Ø 300/280 con disco PTO rigido Ø 280 mm Z.18 e cuscinetti: 55x92,4x50 - 70x132,4x93,4 - 20x52x15</p>

VALPADANA

MOTOCOLTIVATORI: VMC 14	Art. 15016 	OEM 104333 Frizione monodisco a molle elicoidali Piatto Ø 155 mm	Art. 15033 	OEM 104337 Disco frizione rigido in ferodo 155x114x4,5 17x14x4 mm- Z.6	Art. 15059 	OEM 104340 Leva a forcella
	Art. 15051 	OEM 104338 Cuscinetto reggispinta	Art. 15048 	OEM 104334 Manicotto		
MOTOCOLTIVATORI 140	Art. 15608 	OEM Disco frizione rigido 122x80x11,5 mm 28x25EV - Z.15				
MOTOFALCIATRICE SUPER VALPADANA	Art. 15194 	OEM Disco frizione rigido 178x134x2,5 mm 26x21x3 mm Z.10				
MOTOCOLTIVATORI: PADANO D12 - D14 - VMC 18 - TRATTORINI: 4RM20	Art. 15006 	OEM 102776 Frizione monodisco a molle elicoidali Piatto Ø 187 mm	Art. 15038 	OEM 102770 Disco frizione rigido in ferodo 184x127x3,8 22x18x3,5 mm - Z.10	Art. 15069 	OEM 104068 Leva a forcella
	Art. 15052 	OEM 102772 Cuscinetto reggispinta 68x36x19 mm	Art. 15047 	OEM 102773 Manicotto		
4RM330	Art. 15008 	OEM VP116203 Frizione monodisco a molle elicoidali Piatto Ø 187 mm	Art. 15101 	OEM VP125911 Disco rigido frizione 184x127x3,3 mm 22x18x3,5 Z.10	Art. 15052 	OEM VP116061 Cuscinetto reggispinta 68x36x19 mm
TRATTORINI: 4RM 350 - 4RM 450 4RM 555	Art. 15009 	OEM 104952 Frizione monodisco a molle elicoidali Piatto Ø 215 mm	Art. 15027 	OEM 104951 Disco frizione rigido in ferodo 216x152x3,5 22x18x3,5 mm - Z.10	Art. 15069 	OEM 104956 Leva a forcella
	Art. 15052 	OEM 104953 Cuscinetto reggispinta 68x36x19 mm	Art. 15047 	OEM 104954 Manicotto		
MOTOCOLTIVATORI: VMC 160 - VMC 12	Art. 15002 	OEM 109081 Meccanismo monodisco con molle a diaframma Piatto Ø 110 mm	Art. 15019 	OEM 108783 Disco frizione rigido 110x58x1,5 mm 15x12EV - Z.8	Art. 15057 	OEM Leva a forcella
	Art. 15050 	OEM Cuscinetto reggispinta	Art. 15042 	OEM Manicotto con cuscinetto reggispinta		































Frizioni e loro componenti

CLUTCHES - CLUTCH DISK - BEARING - COUPLING - LEVER - SET-REVISION

11

11

















segue VALPADANA

TRATTORI: 4RM 6000 - 6060 (doppia frizione)	Art. 15390 	OEM 116597 Frizione doppia a comandi separati con disco centrale. Senza disco PTO Piatto Ø 215 mm	Art. 15098 	OEM 109917 - 117426 Disco frizione centrale rigido in ferodo 216x152x3,9 mm 35x31EV - Z.18	Art. 15233 	OEM 117169 Disco PTO rigido in ferodo 216x152x3,9 mm 20x17EV - Z.12	
	Art. 16151 	OEM Disco PTO rigido in ferodo 216x152x3,9 mm 18x15 - Z.10	Art. 15268 	OEM 109955 Leva a forcella	Art. 15807 	OEM Cuscinetto reggispinta cambio 82x50x26	
					Art. 15808 	OEM Cuscinetto reggispinta PTO 117x75x27	
MOTOCOLTIVATORE	Art. 15737 	OEM 220534 Frizione Ø 100x88 mm a dischi multipli con 4 dischi	Albero 23 mm Conicità 1:5 15x12 mm - Z.8	Art. 15743 	OEM 220585 Frizione Ø 100x122 mm a dischi multipli	Albero 23 mm Conicità 1:5 15x12 mm - Z.8	
1555	Art. Kit 16203  LUK	 LUK	 LUK	OEM 6510439M91 Kit composto da: - Meccanismo - Disco PTO 15907			
4040	Art. 16219 	OEM VP513342 Frizione Ø 184 mm	Art. 15721 	OEM VP114810 Disco frizione rigido centrale 180x127x3,8 mm 35x31 mm - Z.18	Art. 16221 	OEM VP114180 Disco frizione Ø 184 mm 18x15 - Z.10	
8080 - 9585	Art. Kit 16032  LUK	 LUK	 LUK	 LUK	 LUK	 LUK	OEM Kit composto da: - Meccanismo 15552 - Disco PTO 15971 - Cuscinetti 15990 - 63895 - 63867
	Art. Kit 16031  LUK	 LUK	 LUK	OEM Kit composto da: - Meccanismo 15552 - Disco PTO 15971			
	Art. 15552  LUK	OEM 5138144-5154513-5171493-5139339 Meccanismo a 6 leve completo di disco centrale in ferodo, senza il disco di PTO Piatto Ø 250 mm (10") Intercambiabile con meccanismo VALEO	Art. 15971  LUK	OEM 5128074-5154799 Disco PTO rigido in ferodo 250x155x3,5 mm 22x19EV - Z.13	Art. 15554 	OEM 5128074-5154799 Disco PTO rigido in ferodo 250x155x3,5 mm 22x19EV - Z.13	
	Art. 63363  Art. FAG 63895	OEM 24905350 Cuscinetto PTO 100x65x18 mm	Art. 15990  LUK	OEM 5119290 5119875 - 5122028 - 87345759 Cuscinetto reggispinta cambio 90x50x22 mm	Art. 62581  Art. FAG 63867	OEM 28043280 Cuscinetto volano 17x47x14 mm	
	Art. 15280 	OEM 5119290 - 5119875 - 5122028 - 87345759 Cuscinetto reggispinta cambio 90x50x22 mm					

Frizioni e loro componenti

CLUTCHES - CLUTCH DISK - BEARING - COUPLING - LEVER - SET-REVISION



YTO

<p>X700 X704 X800 X804 X904</p> <p>MECCANISMO RINFORZATO</p> <p>N.B.: Quando si sostituisce un meccanismo non rinforzato con un meccanismo rinforzato, bisogna sostituire anche il disco PTO.</p>	<p>Art. Kit 15929</p>   <p>OEM</p> <p>Kit composto da: - Meccanismo 15505 - Disco PTO 15943</p>		
	<p>Art. Kit 15938</p>   <p>OEM</p> <p>Kit composto da: - Meccanismo 15505 - Disco PTO 15943 - Cuscinetti 15990 - 63896 - 63867</p>		
	<p>Art. 15505</p>  <p>OEM 5162900-5150652 Meccanismo a 6 leve completo di disco centrale metalceramico a 6 pale senza il disco PTO. Piatto Ø 280 mm (11") Intercambiabile con meccanismo VALEO</p>	<p>Art. 15943</p>  <p>OEM 5145715 - 5154703 Disco PTO rigido in ferodo 280x165x3 mm 25x22EV - Z.10</p>	<p>Art. 15520</p>  <p>OEM 5145715 - 5154703 Disco PTO rigido in ferodo 280x165x3 mm 25x22EV - Z.10</p>
	<p>Art. 15414</p>  <p>OEM 5145711 Disco centrale metalceramico a 5 pale con molle parastrappi Ø 280 mm sinterizzato 40x35EV - Z.14</p> <p>Tipo SILA intercambiabile con LUK</p>	<p>Art. 15528</p>  <p>OEM 5162901 Disco centrale metalceramico a 6 pale con molle parastrappi per meccanismo 15505 Ø 280 mm sinterizzato 40x35EV - Z.14</p>	<p>Art. 15523</p>  <p>OEM 5156209 Disco centrale in ferodo con molle parastrappi 280x165x3,5 mm 40x35EV - Z.14</p>
	<p>Art. 15990</p>  <p>OEM 5119290 5119875 - 5122028 Cuscinetto reggispira cambio 90x50x22 mm</p>	<p>Art. 15280</p>  <p>OEM 5119290 5119875 - 5122028 Cuscinetto reggispira cambio 90x50x22 mm Nuova Versione OEM 5197980</p>	<p>Art. 62581</p>  <p>OEM 28043280 Cuscinetto volano 17x47x14 mm</p>
	<p>Art. 15863</p>  <p>OEM 599930 Cuscinetto reggispira</p>	<p>Art. 62951</p>  <p>OEM 24905360 Cuscinetto reggispira PTO 70x110x20 mm</p> <p>Art. FAG 63896</p>	
	<p>Art. 15862</p>  <p>OEM 5103178 Cuscinetto reggispira</p>	<p>Art. 15751</p>  <p>OEM 26794570 Cuscinetto PTO 16013 65x100x11 mm Per mod: 480S-500S-540S-550-600-640</p>	

X1204
MECCANISMO RINFORZATO
N.B.: Quando si sostituisce un meccanismo non rinforzato con un meccanismo rinforzato, bisogna sostituire anche il disco PTO.

<p>Art. Kit 15932</p>   <p>OEM</p> <p>Kit frizione doppia a 6 leve con disco interno e disco PTO Ø 310 mm</p>
--

VALTRA / VALMET

<p>MEGA 8300 MEGA 8800</p>	<p>Art. Kit 15904</p>   <p>OEM</p> <p>Meccanismo bi-disco Ø 310 mm</p>
<p>255 - 305 - 355 - 365 405 - 415 - 455 - 465 555 - 565 - 600 - 665 700 - 800 - 865 - 900 A65 - A73 - A75 - A85 A95 - A72/92 Classic BL77/88</p>	<p>Art. Kit 16092</p>   <p>OEM 82224600 - 82224610 Kit frizione completo Ø 300/280 con disco PTO rigido Ø 280 mm Z.18 mozzo 22x21 Z.18 e disco interno mozzo con 44x40 Z.22 e cuscinetti: 55x92,4x50 - 70x132,4x93,4 - 20x52x15</p>
<p>MEZZO 6000/6100/6200/ 6300/6400/6600/ 6800/6900/8000/ 8100</p>	<p>Art. Kit 16093</p>   <p>OEM 35652000 Kit frizione completo Ø 330 con disco Ø 330 mm Z.22 e cuscinetti: 60x97x26 - 40x68x15</p>

Frizioni e loro componenti

CLUTCHES - CLUTCH DISK - BEARING - COUPLING - LEVER - SET-REVISION

11

11

ZETOR

3011 - 3045 - 3511
- 3545 - 4712 - 4718
- 4911 - 5011

Art. Kit

16086

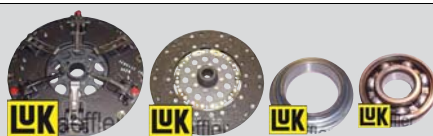

OEM 72010011

Kit frizione completo Ø 280 con disco PTO rigido
Ø 280 mm Z.16 e cuscinetti:
65x101x22,5 - 20x52x15

3320 - 3340 - 4320
- 5011 - 5211 - 5213
- 5243 - 5245 - 5511
- 5545 - 5320 - 5340/
Horal - 5545 - 5611
- 5645 - 5647 - 5745
- 5748 - 5711 - 5718
- 5945 - 6011 - 5911
- 6245 - 6320 - 6340
- 6045 - 6211 - 6718 -
6745 - 6340E - 6711
- 6911 - 6945 - 6748
- 7211 - 7245 - 7011
- 7045 - 7711 - 7320
- 7340 - 7745

Art. Kit

16087



OEM 54021902

Kit frizione completo Ø 310 con disco PTO rigido
Ø 310 mm Z.18 e cuscinetti:
65x101x22,5 - 20x52x15

MAJOR 3320/5320/
5340/6000/3340/
4320/4340/6340/
7320/7340
PROXIMA 6421/6441/
7421/7441/8421/ 8441
SUPER 3321/3341/
4321/4341/5321/5341/
6321E/6341E/7321/
7341
ANTAR 6421/6441/
7421/7441/8421/
8441
PROXIMA 65/70/75/
80/85/90/95
PROXIMA CABRIO
100/65/70/75/80/85/
90/95

Art. Kit

16090



OEM 54021902

Kit frizione completo Ø 310 con disco PTO a 6
pale Ø 310 mm Z.18 e cuscinetti:
65x101x22,5 - 20x52x15

5211 - 5213 - 5243
- 5245 - 5511 - 5545
- 5611 - 5645 - 5647
- 5711 - 5718 - 5745
- 5748 - 5911 - 6011
- 6045 - 6211 - 6245
- 6711 - 6718 - 6745
- 6748 - 6911 - 6945
- 7011 - 7045 - 7211
- 7245 - 7711 - 7745

Art. Kit

16089



OEM 72010011

Kit frizione completo Ø 280 con disco PTO a 6
pale Ø 280 mm Z.18 e cuscinetti:
65x101x22,5 - 20x52x15

FORTERRA 10641/
10741/11441/11641/
11741/12441/8621/
8641/9621/9641/
9741

Art. Kit

16091



OEM 938315

Kit frizione meccanismo Ø 330 mm più disco
rigido Ø 327 mm Z.18

Frizioni e loro componenti

CLUTCHES - CLUTCH DISK - BEARING - COUPLING - LEVER - SET-REVISION

RIEPILOGO CUSCINETTI E MANICOTTI PER FRIZIONI

RÉSUMÉ DE ROULEMENTS Y MANCHONS POUR EMBRAYAGES - SUMMARY OF BEARINGS AND CONNECTIONS FOR CLUTCHES - ZUSAMMENFASSUNF KUPPLUNGSLAGER & HUELSEN - RESUMEN DE COJINETES Y SEPARADORES PARA EMBRAGUES

ARTICOLO	DESCRIZIONE	MISURE	ARTICOLO	DESCRIZIONE	MISURE
15042	Manicotto con cuscinetto reggispinta		15365	Cuscinetto reggispinta	
15043	Manicotto con cuscinetto reggispinta		15404	Cuscinetto reggispinta	
15047	Manicotto		15410	Manicotto con cuscinetto reggispinta	
15050	Cuscinetto reggispinta		15442	Manicotto con cuscinetto reggispinta	
15051	Cuscinetto reggispinta		15514	Cuscinetto reggispinta	
15052	Cuscinetto reggispinta		15629	Manicotto con cuscinetto reggispinta	
15054	Cuscinetto reggispinta		15660	Manicotto con cuscinetto reggispinta	
15055	Cuscinetto reggispinta		15669	Cuscinetto reggispinta	
15272	Cuscinetto reggispinta		15740	Manicotto con cuscinetto reggispinta	
15280	Cuscinetto reggispinta cambio		15742	Cuscinetto reggispinta cambio	
15302	Manicotto con cuscinetto reggispinta		15744	Cuscinetto reggispinta cambio	
15332	Manicotto con cuscinetto reggispinta				

Frizioni e loro componenti

CLUTCHES - CLUTCH DISK - BEARING - COUPLING - LEVER - SET-REVISION

11

segue RIEPILOGO CUSCINETTI E MANICOTTI PER FRIZIONI

RÉSUMÉ DE ROULEMENTS Y MANCHONS POUR EMBRAYAGES - SUMMARY OF BEARINGS AND CONNECTIONS FOR CLUTCHES - ZUSAMMENFASSUNF KUPPLUNGSLAGER & HUELSEN - RESUMEN DE COJINETES Y SEPARADORES PARA EMBRAGUES

ARTICOLO	DESCRIZIONE	MISURE	ARTICOLO	DESCRIZIONE	MISURE
15751	Cuscinetto PTO		15863	Cuscinetto reggispinta	
15752	Cuscinetto reggispinta PTO		15864	Cuscinetto reggispinta	
15753	Cuscinetto con manicotto		15866	Manicotto con cuscinetto reggispinta	
15754	Manicotto con cuscinetto reggispinta		15883	Cuscinetto reggispinta	
15755	Cuscinetto reggispinta		15900	Collare con cuscinetto	
15756	Cuscinetto reggispinta PTO		15936	Cuscinetto	
15758	Manicotto con cuscinetto reggispinta		15980	Cuscinetto reggispinta	
15800	Cuscinetto reggispinta cambio		15990	Cuscinetto reggispinta cambio	
15807	Cuscinetto reggispinta cambio		16043	Manicotto con cuscinetto	
15808	Cuscinetto reggispinta PTO		16046	Manicotto con cuscinetto reggispinta	
15861	Cuscinetto reggispinta		16051	Cuscinetto reggispinta	
15862	Cuscinetto reggispinta				

segue RIEPILOGO CUSCINETTI E MANICOTTI PER FRIZIONI

RÉSUMÉ DE ROULEMENTS Y MANCHONS POUR EMBRAYAGES - SUMMARY OF BEARINGS AND CONNECTIONS FOR CLUTCHES - ZUSAMMENFASSUNF KUPPLUNGSLAGER & HUELSEN - RESUMEN DE COJINETES Y SEPARADORES PARA EMBRAGUES

ARTICOLO	DESCRIZIONE	MISURE
16052	Cuscinetto reggispinta	
16053	Cuscinetto	
new 16125	Cuscinetto reggispinta 	
new 16144	Cuscinetto	
new 16201	Cuscinetto reggispinta	
new 16207	Manicotto spingidisco Goldoni	
new 15741	Manicotto con cuscinetto reggispinta	





Parastrappi

DAMPER

11

MARCA E MODELLO	ARTICOLO	DISEGNO	OEM E MISURE
AGROMEHANIKA			
AGT 850T	16080		OEM Ø 225 mm 22x25 mm Z.14
BCS - FERRARI			
COBRAM 40/AR/RS - COBRAM 50L/AR/RS - VALIANT 400/AR/RS - VALIANT 500L/AR/RS - SYSTEM 50L/AR/RS -	16080		OEM 58173493 Ø 225 mm 22x25 mm Z.14
MARS - ORION - SYSTEM 75/AR/MT/RS - SYSTEM 85/AR/MT/RS - THOR - VANGUARD 750/AR/RS - VANGUARD 800/AR/RS - VEGA - VITHAR - VOLCAN	16081		OEM 58177653 Ø 225 mm 27x30 mm Z.16
CARRARO ANTONIO			
TGF - ERGIT - TRX - TXS - 2190 - Supertigre - Tigrone - Tigretrac - Cargo - Jona - Tigrecar - 9400	16256 		OEM 40110014 Ø 230 mm Z.18
CASE			
JXU 75/85/95/105 JX 1070U / 1080U / 1090U / 1100U	16013		OEM 87527552 Ø 262 mm 35x40 mm Z.14
JXU115 MAXXUM 100/110/115/ 125 MXU 100/110/115/130	16021		OEM 5196061 Ø 262 mm 31x35 mm Z.16
MXM 120/130/140/155/ 175/190/ PUMA 115/125/130/ 140/155/160/165/180/ 195/210/150CVX/ 165CVX/175CVX	16023		OEM 87542609 - 87302871 Ø 348 mm 35x40 mm Z.14
JXU75 - JXU85 - JXU95 - JXU105 - JXU115	16024		OEM 84389461 47554840 Ø 320 mm 35x40 mm - Z.14
MAXXUM 100/110/120/130	16027		OEM 87527558 Ø 395 mm 31x35 mm Z.16
MXM120/130/140/155/165	16016		OEM 87304267 Ø 348 mm 35x40 mm Z.14
CLAAS			
-	16020		OEM 0011563760 Ø 328 mm Z.21









MARCA E MODELLO	ARTICOLO	DISEGNO	OEM E MISURE
DEUTZ			
AGRIFARM 85/ 100/ 410/T/TB/ 420/T/TB/ 430 AGROPLUS 67/ 70/S/F/75S/77/87/ 90S/F/100/S/F/ 310/315/320/F/N/ 330/N/410/F/N/420/N/ 430/F 67.70/75/77/87/90 F70/75/90/100	16020		OEM 0011563760 Ø 328 mm Z.21
AGROTRON 80/ 85/90/100/105/ 110 4.70/80/85/90/95 6.01 K100/110/120/90/ 410/420/430/610 K Profiline 100/ 110/120/90/420/ 430/610 MK3 100/105/80/ 85/90	16019		OEM 044.5502.9 Ø 264 mm 31x35 mm Z.16
AGROPLUS 75/ 85/95/100/	16014		OEM 0.011.3942.4 Ø 263 mm 46x50 mm Z.24
AGROTRON 195/ 200/ L710/L720/L730	16025		OEM 0.013.8769.4/20 0.013.2797.3 Ø 328 mm 50x55 mm Z.26
AGROTRON 195/ 200/160MK3/ 175MK3/200MK3	16017		OEM Ø 320 mm 50x55 mm Z.26
FORD			
8160 - 8260 - 8360 - 8560	16016		OEM 87304267 Ø 348 mm 35x40 mm Z.14
HURLIMANN			
XA 60/66/70/76/ 80/86/90/100 XB 85/90/100/105 XF 70/75/80/90 XS 70/100/110/ 75/90 XV 80/90/100	16020		OEM 0.014.4020.4/10 Ø 328 mm Z.21
XM 100/110/115/ 120/125	16019		OEM 044.5502.9 Ø 264 mm 31x35 mm Z.16
LAMBORGHINI			
R3 EVO RF 70/75/90/100 RS 70/75/90 RV 70/75/99/100	16020		OEM 0.014.4020.4/10 Ø 328 mm Z.21
R. 6100/6110/6120	16019		OEM 044.5502.9 Ø 264 mm 31x35 mm Z.16

MARCA E MODELLO	ARTICOLO	DISEGNO	OEM E MISURE
LANDINI			
MYTHOS REX CAB REX TIER 2 / 3 REX TOP RESTYLING SERIE 4 VISION	16195 		OEM 3648843M91 Ø 263 mm 31x35 mm Z.16
LANDPOWER LEGEND LEGEND N-G LEGEND N-G. TDI SERIE 6L TIER 4	16196 		OEM 3652970M91 Ø 294 mm 50,4X 54,6 mm Z.26



MASSEY FERGUSON

5425/5435/5445/ 5455/5460/6235/ 6245/6255/6265/ 6445/6455/6460/ 6470	16028		OEM 3792448H2 Ø 294 mm 39x42,5 mm Z.26
---	--------------	---	---







NEW HOLLAND

T5030-T5040- T5050-T5060 TL70A-TL80A-TL90A- TL100A	16013		OEM 87527552 Ø 262 mm 35x40 mm Z.14
5640-6640-7740-7840- 8240-8340 TS90-TS100-TS110- TS115	16015		OEM 82008857 Ø 262 mm 28,7x35,2 mm Z.10
TM 120/130/140/150/ 155 M 100/115/135/160	16016		OEM 5187845 Ø 348 mm 35x40 mm Z.14
4635-6635-7635-4835- 5635 L60-L65-L75-L85-L95 TL65-TL70-TL80-TL90- TL100	16018		OEM 5181872 Ø 116 mm 22x15 mm Z.10
T5030 - T5040 - T5050 - T5060 - TL100 - TL100A - TL70 - TL70A - TL80 - TL80A - TL90 - TL90A - L60 - L65 - L75 - L85 - L85 - L95 - 4635 - 4835 - 5635 - 6635 - 7635	16076		OEM 47133433 Ø 136 mm
T5030-T5040-T5050- T5060-T5070	16024		OEM 84389461 47554840 Ø 320 mm 35x40 mm - Z.14
T5070-T6010-T6020- T6030-T6050 TS100A-TS110A-TS115A- TS130A	16021		OEM 5196061 Ø 262 mm 31x35 mm Z.16
TM115-TM125- TM135-TM150-TM165	16022		OEM 5185207 Ø 348 mm 35x40 mm Z.14



segue NEW HOLLAND

TM 120/130/140/155/ 175/190 T 6030/6050/6070/ 6080/6090/6095/7030/ 7040/7050/7060 T7. 130/185/200/210/ 225/165/175/	16023		OEM 87542609 - 87302871 Ø 348 mm 35x40 mm Z.14
T 6010/6020/6040/6060	16027		OEM 87527558 Ø 395 mm 31x35 mm Z.16

SAME

HUERL FASTDRIVE XT 908 EXPLORER 85-95 SILVER 80-85-90-95- 100.4-100.6-105-110	16014		OEM 0.011.3942.4 Ø 263 mm 46x50 mm Z.24
IRON 175S-190S-200 RUBIN 120-135-150-160-180- 200 SILVER 160-180 TITAN SUPERTITAN -145- 150-160-165-190	16017		OEM 0.014.9430.3 Ø 320 mm 50x55 mm Z.26
DZ LAMB SA IRON 100/110/120	16019		OEM 044.5502.9 Ø 264 mm 31x35 mm Z.16
AUDAX 200-220 IRON 175S-190S-200 IRON TIER3 210-190DCR-210DCR- 220DCR SILVER 110-115-130	16025		OEM 0.013.8769.4/20 Ø 328 mm 50x55 mm Z.26
SILVER 80-90-100.4- 100.6	16026		OEM 010.0231.4/30 Ø 263 mm 46x50 mm Z.24
DORADO 66/76/86 DORADO3 60/70/ 80/90/100 EXPLORER3 80/ 85/90/100/110 F 70/75/90/100 S 70/75 V 70/75/90	16020		OEM 0.014.4020.4/10 Ø 328 mm Z.21

VALTRA

N HI TECH 101/ 111e/121/141/91 T 120/130/140ec/ 160/170/180/190 T DIRECT 153/ 163e/183/203 T VERSU 153/ 163e/182/183/213 N 101/111e/	16109		OEM 35303500 - 35652400 Ø 352 mm Z.22
C 100/110/120/e.p./ 130/150/90 M 100/110/120/e.p./ 130/150 XM130 -	16110		OEM 35652300 Ø 352 mm Z.22

Pompe e Cilindri freno e frizione

CLUTCH CYLINDERS, CLUTCH PUMPS AND BRAKE PUMPS

11

11

POMPE FRENO

POMPE DE FREIN - BRAKE-PUMP - BREMSENPUMPE - BOMBA DE FRENO



OLIO MINERALE

ARTICOLO	OEM
16096	CNH: 5145630 - 5177993 - 87354670 CARRARO ANTONIO: 43309022 - 43309048 SAME: 0.257.6638.4/10



OLIO MINERALE

ARTICOLO	APPLICAZIONI	OEM
16060	CNH: Serie TN - TNA - TNVA - TNNA SAME: Antares - Explorer - Row Crop	CNH: 5179371 87354675 SAME: 0.255.6638.4/60 0.257.6538.4/10



OLIO MINERALE

ARTICOLO	APPLICAZIONI	OEM
16123	CASE: JX - JXU - Luxxum NH: T5 - T5000 - TD4F - TD5	87354681 - 87748269 - 87748264 - 47125744 - 87398198 - 85805257 - 48151473



OLIO MINERALE

ARTICOLO	APPLICAZIONI	OEM
16129	8240 - 6640 - 7740 - 7840 - 5640 - 8340 - TS110 - TS100 - TS115 - TS90	NEW HOLLAND: 81869963



FIG.1



FIG.2

ATTENZIONE:
Quando si sostituisce la pompa freno 16128 bisogna sostituire anche l'accumulatore 84045.

WARNING:
While replacing item 16128, item 84045 must be replaced as well.

OLIO MINERALE

ARTICOLO	DESCRIZIONE	APPLICAZIONI	OEM	FIG.
16128	Pompa freno	175 - TM190	NEW HOLLAND: 84530032	1
84045	Accumulatore per 16128		NEW HOLLAND: 5195043	2



OLIO MINERALE

ARTICOLO	APPLICAZIONI	OEM
16126	NEW HOLLAND: T7.230 - T7.245 - T7.260 - T7.270	47777898



ATTENZIONE:
In fase di spurgo pompare con moderazione altrimenti si rovinano le valvole di chiusura.

OLIO MINERALE

ARTICOLO	APPLICAZIONI	OEM
16146	Serie 80, Serie 88, Serie 90, Serie 94	FIAT: 5103927 5103926 5111685



OLIO MINERALE

ARTICOLO	APPLICAZIONI	OEM
16103	Serie TL Serie TM	LANDINI: 3666220M92 CNH: 84558759 - 87343615 - 82006194 - 82018664

segue POMPE FRENO

POMPE DE FREIN - BRAKE-PUMP - BREMSENPUMPE - BOMBA DE FRENO



OLIO DOT 4

ARTICOLO	APPLICAZIONI	OEM
16102	Serie 80 (fino al 30/01/1997)	LANDINI: 3303732M92

new



OLIO DOT 4

ARTICOLO	APPLICAZIONI	OEM
16133	6550, 7550, 8550, serie 80, serie large 10000, 12500, 13000, 14500	LANDINI: 3305623M92



OLIO DOT 4

ARTICOLO	OEM
16101	LANDINI: 1874957M91 MASSEY FERGUSON: 1698670M91



OLIO DOT 4

ARTICOLO	APPLICAZIONI	OEM
16058	Buffalo - Centauro 70 - Centurion 75 - Hercules 160 - Jaguar 95/100 - Leopard 85/90 - Mercury 85 - Tiger - Trident	LANDINI: 3301382M93 SAME: 0.169.6665.4/20



OLIO MINERALE

ARTICOLO	APPLICAZIONI	OEM
16059	Antares - Argon - Dorado - Explorer - Frutteto - Golden - Roller - Silver	LANDINI: 3537810M91 SAME: 0.009.9234.4/10 JD: ER374066 CNH: 87398198

new



OLIO DOT 4

ARTICOLO	APPLICAZIONI	OEM
16224	Serie 80	LANDINI: 3536279M92

new



OLIO MINERALE

ARTICOLO	APPLICAZIONI	OEM
16127	CASE: Serie CX MC CORMICK: Serie CX	CNH: 226301A1

new



OLIO MINERALE

ARTICOLO	APPLICAZIONI	OEM
16211	LAMBORGHINI: Formula - Premium - R4 - RS ³ SAME: Antares - Laser - Silver DEUTZ: Agrotrac	0.008.2190.4/30

new



FTE
automotive
a Valeo brand

OLIO MINERALE

ARTICOLO	APPLICAZIONI	OEM
16262	DEUTZ: Agrotron	04452974.4

Pompe e Cilindri freno e frizione

CLUTCH CYLINDERS, CLUTCH PUMPS AND BRAKE PUMPS

11

11

segue POMPE FRENO

POMPE DE FREIN - BRAKE-PUMP - BREMSENPUMPE - BOMBA DE FRENO

new



FTE
automotive
a Valeo brand

OLIO PENTOSIN CHF11S

ARTICOLO	APPLICAZIONI	OEM
16264	DEUTZ: Agrottron	04414685 04418388

new



OLIO DOT 4

ARTICOLO	APPLICAZIONI	OEM
16131	Farmer 260S - 250S - 240S - 270P - 275P - 310 - 311 - 307 - 308 - 309 - 306 - 305 - 304	FENDT: G178109070110

new



OLIO MINERALE

ARTICOLO	APPLICAZIONI	OEM
16230	512 - 513 - 514 - 516 - 714/NA - 716/NA - 718/NA - 720/NA - 722/NA - 724/NA	FENDT: G350810300101

new



FTE
automotive
a Valeo brand

OLIO DOT 4

ARTICOLO	APPLICAZIONI	OEM
16263	FENDT: Farmer 300C Farmer 300LS (A)	G395100070100 G198104070210

new



OLIO MINERALE

ARTICOLO	APPLICAZIONI	OEM
16220	5460 - 5465 - 5480 6445 - 6475 - 6499	MASSEY FERGUSON: 4286326M2

new



OLIO MINERALE

ARTICOLO	APPLICAZIONI	OEM
16225	7465 - 7475 - 7480 - 7485 - 7490 - 7495 - 7497 - 7499	MASSEY FERGUSON: 4286325M1 4286453M1



OLIO DOT 4

ARTICOLO	APPLICAZIONI	OEM
16159	Special Lux / Car Rimorchio C35/C36/C63 - 80/81	GOLDONI: 02030181 02030499



OLIO DOT 4

ARTICOLO	APPLICAZIONI	OEM
16177	Starcar Transcar 20 - 22 Transcar prima serie	GOLDONI: 02030106



OLIO DOT 4

ARTICOLO	APPLICAZIONI	OEM
16066	Serie 1000	GOLDONI: 02030058

segue POMPE FRENO

POMPE DE FREIN - BRAKE-PUMP - BREMSENPUMPE - BOMBA DE FRENO



OLIO DOT 4

ARTICOLO	APPLICAZIONI	OEM
16067	Serie 400 Transcar FERRARI Sycar 30RS	GOLDONI: 02030051 02030091



OLIO DOT 4

ARTICOLO	APPLICAZIONI	OEM
16190	MTG 500/500RT MTG 700 Universalcar Rimorchio C61 ITMA 600 / 700	GOLDONI: 02030026



OLIO DOT 4

ARTICOLO	APPLICAZIONI	OEM
16191	Universal Universal NUOVO	GOLDONI: 02030014



OLIO DOT 4

ARTICOLO	APPLICAZIONI	OEM
16198	Serie IDEA	GOLDONI: 02030348



OLIO OSO 15

ARTICOLO	APPLICAZIONI	OEM
16199	Cluster Rev Master Rev IDEA	GOLDONI: 02030353



OLIO DOT 4

ARTICOLO	APPLICAZIONI	OEM
16202	Special Lux Transcar Sincro 635 - 636 - 663	GOLDONI: 02030590 02030104



OLIO DOT 4

ARTICOLO	APPLICAZIONI	OEM
16204	Aster	GOLDONI: 02030383

new



OLIO DOT 4

ARTICOLO	APPLICAZIONI	OEM
16229	Euro 40-42-50-55 (fino a matricola 459865)	GOLDONI: 02030205

new



OLIO DOT 4

ARTICOLO	APPLICAZIONI	OEM
16250	Modelli vari	ITMA: 00620484

Pompe e Cilindri freno e frizione

CLUTCH CYLINDERS, CLUTCH PUMPS AND BRAKE PUMPS

11

11

segue POMPE FRENO

POMPE DE FREIN - BRAKE-PUMP - BREMSENPUMPE - BOMBA DE FRENO

SERBATOIO OLIO FRENI

RÉSERVOIR HUILE FREIN
OIL TANK FOR BREAKING CIRCUIT
ÖL BREMSTANK
TANQUE ACEITE FRENOS



ARTICOLO	APPLICAZIONI	OEM
81818	GOLDONI - LANDINI MASSEY FERGUSON VALPADANA	02030064 1425798M91 VP107746L

SERBATOIO COMANDO FRENI SAME

RÉSERVOIR COMMANDE FREINS SAME
SAME BRAKE CONTROL TANK
BEHÄLTER FÜR BREMSSTEUERUNG SAME
DEPÓSITO CONTROL FRENOS SAME



SAME

ARTICOLO	APPLICAZIONI	OEM
13395	ANTARES 110 / 130 EXPLORER II 60 / 70 / 80 / 90 LASER 100	0.257.6654.4/20

TAPPO PER SERBATOIO SAME 13395

BOUCHON POUR RÉSERVOIR SAME 13395
CAP FOR 13395 SAME TANK
DECKEL FÜR BEHÄLTER SAME 13395
TAPÓN PARA DEPÓSITO SAME 13395



SAME

ARTICOLO	APPLICAZIONI	OEM
13396	ANTARES 110 / 130 EXPLORER II 60 / 70 / 80 / 90 LASER 100	0.257.6654.3/10

SERBATOIO COMANDO FRENI CNH

RÉSERVOIR COMMANDE FREINS CNH
CNH BRAKE CONTROL TANK
BEHÄLTER BREMSSTEUERUNG CNH
DEPÓSITO CONTROL FRENOS CNH



CNH

ARTICOLO	APPLICAZIONI	OEM
16281	Serie: 66 - 88 - 90 - 93 - 94	5141671 5105871 4379796

TAPPO PER SERBATOIO CNH 16281

BOUCHON POUR RÉSERVOIR CNH 16281
CAP FOR 16281 CNH TANK
VERSCHLUSS FÜR BEHÄLTER CNH 16281
TAPÓN PARA DEPÓSITO CNH 16281



CNH

ARTICOLO	APPLICAZIONI	OEM
16282	Serie: 66 - 88 - 90 - 93 - 94	5181824 5105873

POMPE FRIZIONI

POMPE POUR EMBRAYAGE - CLUTCH-PUMP - KUPPLUNGSPUMPE - BOMBA PARA EMBRAGUE



OLIO MINERALE

ARTICOLO	APPLICAZIONI	OEM
16097	70/90 - 72/94 - 80/90 - 115/90 - 130/90 - 140/90 - 180/90	CNH: 5119606



OLIO MINERALE

ARTICOLO	APPLICAZIONI	OEM
16130	F100 - F110 - F115 - F120 - F130 - F140 M100 - M115 - M135	CNH: 5150299



OLIO MINERALE

ARTICOLO	APPLICAZIONI	OEM
16098	T7.140 - T7.150 - T7.165 - T7.180	CNH: 84570230

segue POMPE FRIZIONI

POMPE POUR EMBRAYAGE - CLUTCH-PUMP - KUPPLUNGSPUMPE - BOMBA PARA EMBRAGUE

new



OLIO MINERALE

ARTICOLO	APPLICAZIONI	OEM
16135	5640, 6640, 7740, 7840, 8240, 8340, TS100, TS110, TS115, TS90	CNH: 81867084



ATTENZIONE:
per i modelli con OEM
0.010.1148.4/20 può
essere necessario
la regolazione
della forcella ed
eventualmente
accorciare l'asta
filettata.

OLIO MINERALE

ARTICOLO	APPLICAZIONI	OEM
16062	Antares - Dorado - Explorer - Roller - Row Crop - Virtus J	SAME: 0.255.6538.4/60 0.010.1148.4/20



OLIO MINERALE

ARTICOLO	APPLICAZIONI	OEM
16100	Antares 110 - 110II - 130 - 130II - Laser 100>5001 - 1110>10001 - 115.6 Silver 80 - 85 - 90 - 95 - 100.4 - 100.6 - 105 - 110 - 115 - 130	SAME: 0.008.2753.4/20

new



FTE
automotive
a Valeo brand

OLIO MINERALE

ARTICOLO	APPLICAZIONI	OEM
16261	Agrotron 4 / 6.XX / MK II / NEW	DEUTZ: 04411562.4

new



OLIO MINERALE

ARTICOLO	APPLICAZIONI	OEM
16138	Landpower 115BLU, 125, 130BLU, 145, 160BLU, 165, 185 / Landpower IVECO TIER 3 125, 135, 165, 180 - Legend 105, 115, 130, 145, 165 / Legend N.G. 115, 120, 130, 140, 160, 180 / Legend N.G. TDI 125TDI, 130BLU, 135TDI, 145TDI, 160BLU, 165TDI, 185TDI - Mythos 100, 110, 90 / Mythos TIER 2 105, 115	LANDINI: 3558552M91

new



OLIO MINERALE

ARTICOLO	APPLICAZIONI	OEM
16277	3050 - 3055 - 3060 - 3070 - 3075 - 3080 - 3090 - 3095 - 3115 - 3120 - 3120T - 3125	MASSEY FERGUSON: 3388831M4



OLIO OSO 15

ARTICOLO	APPLICAZIONI	OEM
16158	Cluster RS / SN Maxter RS / SN	GOLDONI: 02030375 02030591

OLIO DOT 4

ARTICOLO	APPLICAZIONI	OEM
16157	Transcar 25 non sincro Transcar 25/28/33 sincro Maxter RS / SN	GOLDONI: 02030136 02030592

Pompe e Cilindri freno e frizione

CLUTCH CYLINDERS, CLUTCH PUMPS AND BRAKE PUMPS

11

11

CILINDRI FRIZIONI

CYLINDRE POUR EMBRAYAGE - CLUTCH-CYLINDRE - KUPPLUNGFSZILINDER - CILINDRO PARA EMBRAGUE



ARTICOLO	APPLICAZIONI	OEM
16099	F100 - F110 - F115 - F130 M100 - M115 - M135 70/90 - 72/94 - 80/90 - 115/90 - 130/90 - 140/90	CNH: 5177914 5119605

new



ARTICOLO	APPLICAZIONI	OEM
16213	CASE Serie JXV - JXC - JXN - Quantum - Farmall NEW HOLLAND: Serie T3.XXF Serie T4.XX Serie T5.XX Serie T4000 Serie TND - TNS - TNVA - TNDA	84324333 5185842

new



ARTICOLO	APPLICAZIONI	OEM
16124	VERSIONE TOP Legend: 105 - 115 - 120 - 125 - 130 - 135 - 140 - 145 - 160 - 165 - 180 - 185 Landpower: 115 - 125 - 130 - 135 - 145 - 160 - 165 - 180 - 185 Mythos: 90 - 100 - 105 - 110 - 115	LANDINI: 3552715M91

new



ARTICOLO	APPLICAZIONI	OEM
16139	VERSIONE TECHNO Landpower 115BLU, 125, 130BLU, 145, 160BLU, 165, 185/ Landpower IVECO TIER 3 125, 135, 165, 180 - Legend 105, 115, 130, 145, 165/ 130 N.G. 115, 120, 130, 140, 160, 180/ 130 N.G. TDI 125TDI, 130BLU, 135TD1, 145TDI, 160BLU, 165TDI, 185TDI	LANDINI: 3552714M91



ARTICOLO	APPLICAZIONI	OEM
16063	Antares - Explorer - Laser - Row Crop - Silver - Virtus J	SAME: 0.255.6537.4/60



ARTICOLO	APPLICAZIONI	OEM
16064	Dorado - Frutteto - Golden - Roller	SAME: 0.007.1961.4/10



ARTICOLO	APPLICAZIONI	OEM
16065	Laser - Galaxi	SAME: 0.257.6537.4/40



ARTICOLO	APPLICAZIONI	OEM
16155	Maxter RS Maxter SN	GOLDONI: 02030498 02030593

OLIO DOT 4



ARTICOLO	APPLICAZIONI	OEM
16156	Cluster RS Cluster SN Maxter RS Maxter SN	GOLDONI: 02030359 02030589

OLIO OSO 15

CILINDRI FRENO

CYLINDRE POUR FREIN - BRAKE-CYLINDRE - BREMSENZILINDER - CILINDRO PARA FRENO

new



OLIO DOT 4

ARTICOLO	APPLICAZIONI	OEM
16265	Farmer 200 / 300C / 300LS / 300 TMAIK	FENDT: F158100150011 G158100150020

new



OLIO DOT 4

ARTICOLO	APPLICAZIONI	OEM
16266	Farmer 200	FENDT: G246100150010

new



OLIO DOT 4

ARTICOLO	APPLICAZIONI	OEM
16267	Favorit 600	FENDT: F184108150140

new



OLIO MINERALE

ARTICOLO	APPLICAZIONI	OEM
16137	Serie Legend 105-115-130-145 - Legend N.G. 115,120 130,140,160,180 TDI 125, 130, 135, 145, 160, 165, 185/ Landpower 115 BLU, 125, 130BLU, 135, 145,160BLU, 165, 185 Serie Ghibli/Serie Mythos	LANDINI: 3556022M91

new



OLIO DOT 4

ARTICOLO	APPLICAZIONI	OEM
16134	Serie 40, Serie 80, Frutteti Serie 530, Frutteti Serie 560, 6550, 8550, Serie Large 10000, 12500, 13000, 14500	LANDINI: 3302605M91

new



OLIO MINERALE

ARTICOLO	APPLICAZIONI	OEM
16136	Globus 50-60-70-75; Legend 105-115-130-145 fino al 28/02/97 fino matr. E04059; Frutteti Serie Advantage Serie Atlas	LANDINI: 3537812M91

new



OLIO DOT 4

ARTICOLO	APPLICAZIONI	OEM
16132	6550, 7550, 8550, Serie Large 10000, 12500, 13000, 14500	LANDINI: 785625M92



OLIO DOT 4

ARTICOLO	APPLICAZIONI	OEM
16079	Starcar - Transcar - Euro sn Evo	GOLDONI: 00028619



OLIO DOT 4

ARTICOLO	APPLICAZIONI	OEM
16078	Serie: 400 - 500 - 700 - 800 - 1000 Transcar - Trasporter C55 - C59 - C61	GOLDONI: 00005200

Pompe e Cilindri freno e frizione

CLUTCH CYLINDERS, CLUTCH PUMPS AND BRAKE PUMPS

11

11

segue CILINDRI FRENO



CYLINDRE POUR FREIN - BRAKE-CYLINDER - BREMSENZILINDER - CILINDRO PARA FRENO







 <div style="border: 1px solid black; padding: 2px; width: fit-content; margin: 5px auto;"> GANASCIA PER 16175 16153 </div>			 <div style="border: 1px solid black; padding: 2px; width: fit-content; margin: 5px auto;"> GANASCIA PER 16175 16153 </div>			 <div style="border: 1px solid black; padding: 2px; width: fit-content; margin: 5px auto;"> GANASCIA PER 16181 16178 </div>		
OLIO DOT 4			N.B.: per tamburo freno Ø250mm OLIO DOT 4			N.B.: per tamburo freno Ø220mm OLIO DOT 4		
ARTICOLO	APPLICAZIONI	OEM	ARTICOLO	APPLICAZIONI	OEM	ARTICOLO	APPLICAZIONI	OEM
16175	MTG 500 Transcar Transporter Universalcar	GOLDONI: 00003606	16180	Rimorchio C35/C36/C63 Special Lux Special Car	GOLDONI: 0025718	16181	Rimorchio C35/C36/C63/80/81 Special Lux Special Car	GOLDONI: 00017529
 <div style="border: 1px solid black; padding: 2px; width: fit-content; margin: 5px auto;"> OLIO DOT 4 </div>								
ARTICOLO	APPLICAZIONI	OEM						
16252	Aster Quasar Cluster Rs Reversible	GOLDONI: 00043485 00061687						

GANASCE FRENO

MÂCHOIRES DE FREIN - BRAKE SHOES - BREMSBACKEN - ZAPATAS DE FRENO









 <p>Ganascia freno abbinata al cilindro 16079 <i>Brake shoes pared to 16079</i></p>			 <p>Ganascia freno abbinata al cilindro 16078 <i>Brake shoes pared to 16078</i></p>			 <p>Ganascia freno 250x50 GOLDONI</p>		
ARTICOLO	APPLICAZIONI	OEM	ARTICOLO	APPLICAZIONI	OEM	ARTICOLO	APPLICAZIONI	OEM
16148	Starcar - Transcar - Euro sn Evo	GOLDONI: 00028604	16149	Serie: 400 - 500 - 700 - 800 - 1000 Transcar - Trasporter - C59 - C61	GOLDONI: 00005194	16153	Serie 500 - Special Lux - Special Car - Transcar 20/22 - Trasporter - Trasporter Universalcar - C35 - C36 - C63 - 80 - 81	GOLDONI: 00003605
 <p>Ganascia freno 290x60 GOLDONI</p>			 <p>Tamburo freni Ø 220</p>			 <p>Tamburo freni Ø 220</p>		
ARTICOLO	APPLICAZIONI	OEM	ARTICOLO	APPLICAZIONI	OEM	ARTICOLO	APPLICAZIONI	OEM
16154	900 RS/DT Euro RS Euro RS EVO C59	GOLDONI: 00013854	16178	Rimorchio C35/C36/C63/80/81 Special Lux Special Car	GOLDONI: 00017534	16179	Rimorchio C35/C36/C63/C62/ 80/81	GOLDONI: 00005286







MARCA E MODELLO	ARTICOLO E DESCRIZIONE	DISEGNO	OEM E MISURE
55 - 55DT - 65 - 65DT	15242 BANDELLA INCOLLATA IN TESSUTO		OEM 5160714 Mis. 188x56x6 mm Occhiello esterno Ø 25 mm Occhiello esterno Ø 14 mm
	15487 BANDELLA RIVETTATA IN TESSUTO		OEM 5160714 Mis. 188x56x6 mm
	15674		OEM Ceppo in tessuto per bandella 15487

MARCA E MODELLO	ARTICOLO E DESCRIZIONE	DISEGNO	OEM E MISURE
C80.46 - C80.56 - C80.66 - C80.76 - 60C - 70C - 80C	15676 BANDELLA INCOLLATA IN TESSUTO		OEM 5164940 Mis. 214x65x6 mm
	15247 BANDELLA INCOLLATA IN TESSUTO		OEM 5161638 - 5123188 - 48097881 Mis. 214x60x6 mm
	15490 BANDELLA RIVETTATA IN TESSUTO		OEM 5123188 Mis. 214x60x6 mm
	15491 IN CONGLOMERATO		OEM Ceppo per bandella 15490
	15703 IN TESSUTO		OEM Ceppo per bandella 15490
	15677		OEM Ceppo in tessuto per bandella 15676

CARRARO S.P.A. - CINGOLI

AGRIFULL CINGOLI

C60 - C70 C70 Special	15691 BANDELLA INCOLLATA IN TESSUTO		OEM 4965138 - 4996577 - 4965141 Mis. 214x50x6 mm
	15500 BANDELLA RIVETTATA IN TESSUTO		OEM 4965138 - 4996577 - 4965141 Mis. 214x50x6 mm
	15675		OEM Ceppo in tessuto per bandella 15500
C80.50	15243 BANDELLA INCOLLATA IN CONGLOMERATO		OEM 5109313 Mis. 214x50x6 mm
	15692 BANDELLA RIVETTATA IN TESSUTO		OEM 5109313 Mis. 214x50x6 mm
	15488		OEM Ceppo in conglomerato per bandella 15489
	15675		OEM Ceppo in tessuto per bandella 15489
C80 - 70 Special	15244 BANDELLA INCOLLATA IN TESSUTO		OEM 5161640 Mis. 214x50x6 mm





















655C - 6300C	15080 BANDELLA RIVETTATA IN TESSUTO		OEM 101169 Mis. 212x90x6 mm
	15678		OEM Ceppo in tessuto per bandella 15080
450C - 450CL - 455C - 505C - 555C - 655C - 3500C - 4500C	15691 BANDELLA INCOLLATA IN TESSUTO		OEM 86393 Mis. 214x50x6 mm
	15500 BANDELLA RIVETTATA IN TESSUTO		OEM 86393 Mis. 214x50x6 mm
	15675		OEM Ceppo in tessuto per bandella 15500
50.5 620.5	15768 BANDELLA RIVETTATA IN TESSUTO		OEM





















Bandelle freno

BRAKE BAND

11

11

MARCA E MODELLO	ARTICOLO E DESCRIZIONE	DISEGNO	OEM E MISURE	MARCA E MODELLO	ARTICOLO E DESCRIZIONE	DISEGNO	OEM E MISURE
FIAT RUOTE				segue FIAT RUOTE			
La piccola - 200R - 211R - 215R - 221R - 231R - 241R - 251R - 220R -	15152 BANDELLA RIVETTATA IN TESSUTO		OEM 5163521 582539-593868 Mis. 198x38x5 mm		15493		OEM 582691 Ceppo in conglomerato per bandella 15683 - 15082
250 - 300 - 300DT - 350 - 350N - 350S - 350NS - 420 - 420DT	15155 BANDELLA INCOLLATA IN TESSUTO		OEM 5161240 Mis. 210x38x5 mm		15686		OEM 582691 Ceppo in tessuto per bandella 15684 - 15685
	15170 BANDELLA INCOLLATA IN CONGLOMERATO		OEM 5161240 Mis. 210x38x5 mm	450 - 450DT - 480 - 480DT - 480 Vigneto - 500 - 500DT - 540 - 540DT - 550 - 550DT - 600 - 600DT - 640 - 640DT	15239 BANDELLA INCOLLATA IN CONGLOMERATO		OEM 4980314-5107956 Mis. 188x50x6 Occhiello Ø 22 esterno e Ø 14 mm interno.
	15680 BANDELLA RIVETTATA IN CONGLOMERATO		OEM 4966601-5161240 Mis. 210x38x5 mm		15687 BANDELLA INCOLLATA IN TESSUTO		OEM 4980314-5107956 Mis. 188x50x6 Occhiello Ø 22 esterno e Ø 14 mm interno.
	15681 BANDELLA RIVETTATA IN TESSUTO		OEM 4966601-5161240 Mis. 210x38x5 mm		15083 BANDELLA RIVETTATA IN CONGLOMERATO		OEM 4954030-4963008 Mis. 188x50x6 Occhiello Ø 22 mm esterno e Ø 14 mm interno.
	15492		OEM 597871-597872 Ceppo in conglomerato per bandella 15680-15170		15688 BANDELLA RIVETTATA IN TESSUTO		OEM 4954030-4963008 Mis. 188x50x6 Occhiello Ø 22 esterno e Ø 14 mm interno.
	15682		OEM 597871-597872 Ceppo in tessuto per bandella 15681-15155		15494		OEM 596209 Ceppo in conglomerato per bandella 15239-15083
311R - 312 - 315 - 331R - 411R-T - 415 - 431R	15683 BANDELLA INCOLLATA IN CONGLOMERATO		OEM 582691 5161239 Mis. 176x50x6 mm		15689		OEM 596209 Ceppo in tessuto per bandella 15687-15688
	15684 BANDELLA INCOLLATA IN TESSUTO		OEM 582691 5161239 Mis. 176x50x6 mm	440 - 440DT - 440 Vigneto - 450 - 450DT - 480 - 480 Vigneto - 480S - 480.8 - 480.8 DT - 550 - 550DT - 600 - 600DT 500 - 500DT	15241 BANDELLA INCOLLATA IN TESSUTO		OEM 4996432-5112676 Mis. 188x50x6 mm Occhiello Ø 25 mm esterno.
	15082 BANDELLA RIVETTATA IN CONGLOMERATO		OEM 582691 5161239 Mis. 176x50x6 mm				
	15685 BANDELLA RIVETTATA IN TESSUTO		OEM 582691 5161239 Mis. 176x50x6 mm				



















MARCA E MODELLO	ARTICOLO E DESCRIZIONE	DISEGNO	OEM E MISURE	MARCA E MODELLO	ARTICOLO E DESCRIZIONE	DISEGNO	OEM E MISURE
segue FIAT RUOTE				segue FIAT CINGOLI			
480S - 480.8 - 480.8DT - 480 Vigneto - 500 - 500DT - 540 - 540DT - 640 - 640DT	15240 BANDELLA INCOLLATA IN TESSUTO		OEM 5107958 Mis. 188x56x6 mm Occhiello esterno Ø 22 mm Occhiello interno Ø 14 mm	311C - 332C - 351C - 352C - 355C - 400C - 411C - 411CL - 451C - 455C - 455C Super - 505C - 505C Super - 555C - 605C - 605C Super	15248 BANDELLA INCOLLATA IN CONGLOMERATO		OEM 593873- 4965138-4996577 Mis. 214x50x6 mm
	15242 BANDELLA INCOLLATA IN TESSUTO		OEM 5112685 5112686-5160714 Mis. 188x56x6 mm Occhiello esterno Ø 25 mm Occhiello interno Ø 14 mm		15691 BANDELLA INCOLLATA IN TESSUTO		OEM 593873 - 4965138 - 4996577 - 4965141 Mis. 214x50x6 mm
	15487 BANDELLA RIVETTATA IN TESSUTO		OEM 5107958 Mis. 188x56x6 mm		15500 BANDELLA RIVETTATA IN TESSUTO		OEM 593873 - 4965138 - 4996577 - 4965141 Mis. 214x50x6 mm
	15085 BANDELLA RIVETTATA IN CONGLOMERATO		OEM 5107958 Mis. 188x56x6 mm		15488		OEM 76028900 Ceppo in conglomerato per bandella 15248
	15495		OEM Ceppo in conglomerato per bandella 15085		15675		OEM Ceppo in tessuto per bandella 15500
	15674		OEM Ceppo in tessuto per bandella 15240-15487		555C - 605C - 605C Super	15248 BANDELLA INCOLLATA IN CONGLOMERATO	
FIAT CINGOLI							
25C - 25CL - 25CF - 25CS - (fino al telaio N° 600600)	15081 BANDELLA RIVETTATA IN CONGLOMERATO		OEM 536465 Mis. 198x50x6 mm	15691 BANDELLA INCOLLATA IN TESSUTO		OEM 5109325 - 4965141 Mis. 214x50x6 mm	
	15690 BANDELLA RIVETTATA IN TESSUTO		OEM 536465 Mis. 198x50x6 mm	15500 BANDELLA RIVETTATA IN TESSUTO		OEM 5109325 - 4965141 Mis. 214x50x6 mm	
	15496		OEM Ceppo in conglomerato per bandella 15081	15488		OEM 76028900 Ceppo in conglomerato per bandella 15248	
	15679		OEM Ceppo in tessuto per bandella 15690	15675		OEM 76028900 Ceppo in tessuto per bandella 15500	

Bandelle freno

BRAKE BAND

11

11

MARCA E MODELLO	ARTICOLO E DESCRIZIONE	DISEGNO	OEM E MISURE	MARCA E MODELLO	ARTICOLO E DESCRIZIONE	DISEGNO	OEM E MISURE		
segue FIAT CINGOLI				segue FIAT CINGOLI					
355C - 400C - 411C - 411CL - 451C - 455C - 455C Super - 505C - 505C Super - 55.65 Frutteto - 55.65 Vigneto - 55.65 Montagna - 60.65 Vigneto - 55.75 Frutteto - 55.75 Vigneto - 60.75 Montagna - 60.75 Vigneto	15243		OEM 5109313 Mis. 210x50x6 mm	60.65 Frutteto - 60.65 Montagna - 70.65 - 70.65 Montagna - 80.65 - 60.75 Frutteto - 60.75 Montagna - 70.75 - 70.75 Montagna - 80.75	15247		OEM 5123188 - 5161638 Mis. 210x60x6 mm		
	BANDELLA INCOLLATA IN CONGLOMERATO	15244			OEM 5109313 Mis. 210x50x6 mm	BANDELLA INCOLLATA IN TESSUTO	15490		OEM 5123188 Mis. 210x60x6 mm
	BANDELLA INCOLLATA IN TESSUTO	15489			OEM 5109313 Mis. 210x50x6 mm	BANDELLA RIVETTATA IN TESSUTO	15491		OEM Ceppo per bandella 15490
	15489		OEM 5109313 Mis. 210x50x6 mm	15703		OEM Ceppo per bandella 15490			
	IN CONGLOMERATO	15692		OEM 5109313 Mis. 210x50x6 mm	IN TESSUTO				
	BANDELLA RIVETTATA IN TESSUTO	15488		OEM Ceppo in conglomerato per bandella 15489					
	15675		OEM Ceppo in tessuto per bandella 15692						
55.65 Frutteto - 55.65 Vigneto - 55.65 Montagna - 60.65 Vigneto - 55.75 Frutteto - 55.75 Vigneto - 55.75 Montagna - 60.75 Vigneto	15676		OEM 48097881 - 5164940 Mis. 210x65x6 mm	FL4C - FL4C Idrovert - FL4D Idrovert - FL4 LM - 605 C - 605 C. SUP.	15498		OEM 4996583-4996584 Mis. 210x56x6 mm		
BANDELLA INCOLLATA IN TESSUTO	15677		OEM Ceppo in tessuto per bandella 15676	15086		OEM 4996583-4996584 Mis. 210x56x6 mm			
				15504		OEM 4996583-4996584 Ceppo in tessuto per bandella 15086			
				70 - 80 - 90 - 100 - 120 1355	15770		OEM Mis. 134x92x6,5 mm		
				SERIE CEPPI	15771		OEM Mis. 134x92x8 mm		
				SERIE CEPPI MAGGIORATI 1,5	15772		OEM 5161610 Mis. 122x92x6,5 mm		

MARCA E MODELLO	ARTICOLO E DESCRIZIONE	DISEGNO	OEM E MISURE
FIAT ALLIS			
655C 805C Mod. 5 FL 6	15695 BANDELLA RIVETTATA IN TESSUTO		OEM Mis. 119x90x6,5 mm
	15696		OEM Ceppo in tessuto per bandella 15695
FA 100 FA 150 FL 7 - 8 - 9	15770 SERIE CEPPI		OEM Mis. 134x92x6,5 mm
	15771 SERIE CEPPI MAGGIORATA 1,5		OEM Mis. 134x92x8 mm
FL 10 FL 14	15773 SERIE CEPPI		OEM Mis. 171x90x6 mm
FD 20 FL 20 FP 60	15774 SERIE CEPPI		OEM Mis. 153x120x8 mm

GOLDONI - ITMA

C45 3.45 3.40 Nike 280 Nike 300LL	16205 BANDELLA FRENO		OEM 00660189 Mis. 171x40x6 mm
C60 3.60	15768 BANDELLA RIVETTATA IN TESSUTO		OEM 00660188

LAMBORGHINI RUOTE

R230 - R230DT - R340 - R340DT	15088 BANDELLA RIVETTATA IN TESSUTO		OEM 400.1801.3 Mis. 196x50x6 mm
	15679		OEM Ceppo in tessuto per bandella 15088

LAMBORGHINI CINGOLI

C230 - C230S - C340	15089 BANDELLA RIVETTATA IN TESSUTO		OEM 400.5005.5 Mis. 198x50x6 mm
	15679		OEM Ceppo in tessuto per bandella 15089
C483 C483S C503 Std C553 Std C554 C664 C683	15236 BANDELLA RIVETTATA IN TESSUTO		OEM 424.5411.4 Mis. 196x60x6 mm
	15513		OEM Ceppo in tessuto per bandella 15236
C503 - C533 - C583 - C603 - C653	15499 BANDELLA RIVETTATA IN TESSUTO		OEM 433.5411.4 Mis. 214x50x6 mm
	15675		OEM Ceppo in tessuto per bandella 15499
C684L / STD C704 C754 C783 C784	15097 BANDELLA		OEM 157.5411.3/10 Mis. 210x60x6 mm
	15702		OEM Serie ceppi in tessuto per bandella 15097

LANDINI CINGOLI

C4500 C5500 C6000 CL6000 TL6C C14000 C4830F C5000STD C5830F C6030F C6500 C6830F CL5000	15090 BANDELLA RIVETTATA IN CONGLOMERATO		OEM 1824761M91 Mis. 214x50x6 mm
	15698 BANDELLA RIVETTATA IN TESSUTO		OEM 582691 Mis. 214x50x6 mm
	15488		OEM Ceppo in conglomerato per bandella 15090
	15675		OEM Ceppo in tessuto per bandella 15698
	15769 BANDELLA RIVETTATA IN TESSUTO		OEM 3549085M91

Bandelle freno

BRAKE BAND

11

11

MARCA E MODELLO	ARTICOLO E DESCRIZIONE	DISEGNO	OEM E MISURE
segue LANDINI CINGOLI			
C7800 - C7830	15091 BANDELLA RIVETTATA IN TESSUTO		OEM 3300299M91 Mis. 121x60x6 mm
	15165		OEM 3300302M2 Ceppo in tessuto per bandella 15091

MASSEY FERGUSON CINGOLI

MF134C MF154C MF144C MF164C MF174C MF234CF MF254C MF254CF MF274C MF274CF	15090 BANDELLA RIVETTATA IN CONGLOMERATO		OEM 1824761M91 Mis. 214x50x6 mm
	15698 BANDELLA RIVETTATA IN TESSUTO		OEM 1824761M91 Mis. 214x50x6 mm
	15488		OEM Ceppo in conglomerato per bandella 15090
	15675		OEM Ceppo in tessuto per bandella 15698
MF194C - MF294C	15091 BANDELLA RIVETTATA IN TESSUTO		OEM 3300299M91 Mis. 121x60x6 mm
	15165		OEM 3300302M2 Ceppo in tessuto per bandella 15091
MF200C - MF244C	15092 BANDELLA RIVETTATA IN TESSUTO		OEM 1452972M91 2739931M91 Mis. 214x60x6 mm
	15699		OEM Ceppo in tessuto per bandella 15092 Mis. 214x60x6 mm
MF300C	15093 BANDELLA RIVETTATA IN TESSUTO		OEM 1432906M94 Mis. 208x75x8 mm

MARCA E MODELLO	ARTICOLO E DESCRIZIONE	DISEGNO	OEM E MISURE
SAME RUOTE			
Centauro 55-60-65 - Corsaro 70 - 70 Syncro	15097 BANDELLA RIVETTATA IN TESSUTO		OEM 157.5411.3/10 Mis. 210x60x6 mm
	15702		OEM Serie ceppi in tessuto per bandella 15097
Falcon - Minitauro 50-55-60 Frutteto - 60 Vigneto	15095 BANDELLA RIVETTATA IN TESSUTO		OEM 146.5411.3/10 Mis. 178x60x6 mm
	15701		OEM Serie ceppi in tessuto per bandella 15095
Centauro 1° tipo	15096 BANDELLA RIVETTATA IN TESSUTO		OEM 135.5411.4 Mis. 210x60x6 mm

SAME CINGOLI

Condor C Falcon C Solar 55C Solar 60C	15236 BANDELLA RIVETTATA IN TESSUTO		OEM 424.5411.4 Mis. 196x60x6 mm
	15513		OEM Ceppo in tessuto per bandella 15236
Falcon C - Minitaurus 60C - Taurus C	15500 BANDELLA RIVETTATA IN TESSUTO		OEM 160.5411.2 Mis. 214x50x6 mm
	15675		OEM 424.5412.0 Ceppo in tessuto per bandella 15500

RIVETTI PER BANDELLE

RIVETS
RIVETS
ROHRNIETEN
REMACHE HUECO

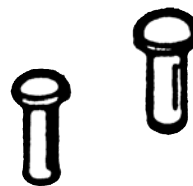

ARTICOLO	DESCRIZIONE	CONFEZIONE
15652	RIVETTO 5x12 TESTA 10	1 kg
15655	RIVETTO 5x15 TESTA 10	1 kg

DISCHI FRENO - ANELLI FRENO

DISQUE DE FREIN - ANNEAU DE FREIN
DISC BRAKE PADS - BRAKE FACING
BREMSEN SCHEIBEN - BREMSEN RING
DISCOS FRENOS - ANILLOS FRENOS



MODELLO	ARTICOLO	DESCRIZIONE	MATERIALE	DIMENSIONI mm	OEM
AGRIFULL					
45 - 45DT - 50 - 50DT - 55V-F-FDT - 55 - 60 - 70 - 70DT - 70E - 70E DT - 80 - 80DT - 80E - 80E DT - 80F - 80F DT - 80.46E - 80.56 - 80.56E - 80.66 - 80.66E - 80.76 - 80.76E	15132	Disco freno	Sinterizzato	165x41x4,8 45x41 - Z.22	5159830
	15254	Disco freno	Acciaio	171,7x94,3x2,65	5119327
R235 Vigneto - R335 Vigneto - R345 - R350 Sprint - Jolly 50 - Derby 60 - Griso 70 - 80.50	15257	Disco freno	Conglomerato	128x70x4 40x36 - Z.20	44905820
	15250	Anello per disco 15257	Conglomerato		9955369
Tornado 80 - Rodeo 90 turbo - 95 turbo	15462	Disco freno	Conglomerato	178x101x4,8 40x36 - Z.20	44983301
	15164	Anello per disco 15462	Conglomerato		0012.5411.0/10
80.60 - 80.75 - 80.85 - 80.60V-F - 80.70 - 80.70F - 80.95 - 80.105	15252	Disco freno	Sinterizzato	261x50x10 63x50 - Z.14	4997208
	15463	Disco freno	Acciaio	325x175x5	5110138
90 - 90DT - 100 - 100DT - 110 - 110DT - 90E - 90E DT - 100E - 100E DT - 110E - 110E DT	15253	Disco freno	Sinterizzato	304x65x10 71x57 - Z.14	4993585
	15466	Disco freno	Acciaio	374x215x5	5110139
140 - 140 Turbo	15467	Disco freno	Sinterizzato	365x62x10 78x62 - Z.13	5102783
	15468	Disco freno	Acciaio	445x240x7	5111281

BCS

Vanguard 500 - 550 - 700 - 750 - 800RS	15254	Disco freno	Acciaio	171,7x94,3x2,65	58171019
--	--------------	-------------	---------	-----------------	----------

CARRARO S.P.A.



602 - 604 - 652 - 654 - 702 - 704 - 732 - 734 - 6000 - 48.2 - 48.2FV - 48.4 - 48.4FV - 58.2 - 58.2FV - 58.4 - 58.4FV - 68.2 - 68.4 - Nuovo ok: 520.2 - 520.2V - 520.4 - 520.4V - 620.2 - 620.2F - 620.4 - 620.4F - 620.4V - 720.2 - 720.2F - 720.2V - 720.4 - 720.4F - 720.4V - 820.4V	15131	Disco freno	Conglomerato	152x80x4,8 48x44 - Z.23	90959
	15135	Anello per disco 15131	Conglomerato		65028 41381
Nuovo ok: 520.2 - 520.2V - 520.4 - 520.4V - 620.2 - 620.2F - 620.2V - 620.4 - 620.4F - 620.4V - 720.2 - 720.2F - 720.2V - 720.4 - 720.4F - 720.4V - 820.4V	15132	Disco freno	Sinterizzato	165x41x4,8 45x41 - Z.22	117166
	15254	Disco freno	Acciaio	171,7x94,3x2,65	117167
78.2 - 78.4 - 88.2 - 88.4	15255	Disco freno	Conglomerato	178x101x4,8 48x44 - Z.23	104822
	15164	Anello per disco 15255	Conglomerato		65289

Dischi e anelli freno



DISC BRAKE PADS-BRAKE FACING

11

11



MODELLO	ARTICOLO	DESCRIZIONE	MATERIALE	DIMENSIONI mm	OEM
DEUTZ					
Agrofarm 100 - 420 - 430 Agrolux 90 - 95 - 100 Agroplus 100 Agrotrac 110	 16273	Disco freno	Sinterizzato	Ø 280 - Z.12	0.001.3765.2
Agrolux 80 - 87 - 90 - 97 - 97LP Agroplus 75 - 85 - 95 - 95 NEW Agrotrac 100	 16274	Disco freno	Sinterizzato	Ø 282 46,5x60 - Z.12	0.009.7067.2 0.445.5447.2 0.445.5447.2/10
Agrocompact Agrolux Agromaxx Agroplus Serie 4E / EF Serie 5D / DF / DK / DS / DV	 16278	Disco freno	Sinterizzato	Ø 225 38x49 - Z.12	0.008.5173.2 0.011.0587.2 0.015.4482.2

FIAT - NEW HOLLAND - FORD

460 - 460DT - 470 - 470DT - 470S - 470S DT - 474 - 474DT	15257	Disco freno	Conglomerato	128x70x4 40x36 - Z.20	44905820
	15250	Anello per disco 15257	Conglomerato		44902294
570 Vigneto - 570 Frutteto - 570 Frutteto DT 570 - 570DT - 580 - 580DT - 670 - 670DT - 680 - 680DT - 670 Frutteto - 670 Frutteto DT 780 - 780DT - 780E - 780E DT	15252	Disco freno	Sinterizzato	261x50x10 63x50 - Z.14	4997208
	15463	Disco freno	Acciaio	325x175x5	5110138
650 - 650DT - 650 Special - 715 - 750 - 750DT - 800 - 800E - 900 - 900E - 1100 - 1100E	15464	Disco freno	Conglomerato	230x160x6 60x55 - Z.22	5160738 44092218
366 - 366DT - 466 - 466DT - 566 - 566DT - 566E - 566E DT - 666 - 666DT - 666E - 666E DT - 766 - 766DT - 766E - 766E DT - 45.66 - 46.66DT - 46.66V DT - 50.66 - 55.66V - 55.66F DT - 55.56 - 55.56DT - 50.56 - 60.56DT - 65.56 - 65.56DT - 70.56 - 70.56DT - 55.66 - 55.66DT - 55.66LP- E-LPDT - 60.66 - 60.66DT - 60.66LP - 65.66LP - 65.66DT - 70.66LP - LPDT - 80.66F - 80.66F DT - 80.66 - 80.66DT	15132	Disco freno	Sinterizzato	165x41x4,8 45x41 - Z.22	5159830
	15254	Disco freno	Acciaio	171,7x94,3x2,65	5119327
880 - 880DT - 880/5 - 880/5DT - 980 - 980DT - 880E - 880E DT - 980 - 980E DT - 90.90 - 90.90DT - 100.90 - 100.90DT - 110.90 - 110.90DT	15253	Disco freno	Sinterizzato	304x65x10 71x57 - Z.14	4993585
	15466	Disco freno	Acciaio	374x215x5	5110139
1180 - 1180DT - 1280 - 1280DT - 1380 - 1380DT - 1580 - 1580DT - 1580DT Turbo - 1880 - 1880DT - 115.90 - 115.90DT - 130.90 Turbo - 130.90DT Turbo - 140.90 Turbo - 140.90 DT Turbo - 160.90 Turbo - 160.90DT Turbo - 180.90 Turbo - 180.90DT Turbo	15467	Disco freno	Sinterizzato	365x62x10 78x62 - Z.13	5102783
	15468	Disco freno	Acciaio	445x240x7	5111281
100/90 - 70/66S - 80/66S - TD5040 - TD55D - TD60D - TD65D - TD70D - TD75D - TD80D - TD90D - TD95D	15810	Disco freno	Acciaio	152x100x1,50 Z.6	5163840 84177629
70/90DT - 90/90DT - 80/66DT - 80/90DT - 80/88DT - 85/90DT - 70/88DT - 70/66DT - 70/66SDT - 80/66SDT - 100/90 - 100/90DT - 110/90DT - 110/90 - TD5.105 - TD5.95 - TD5.115 - TD5050 - TD5030 - TD5040 - TD55D - TD75D - TD55D - TD60D - TD65D - TD70D - TD90D - TD75D - TD80D - TD80D PLUS - TD85D - TD95D - TD90D - TD95D - TD95D PLUS	15819	Disco freno	Sinterizzato	140x91x2 Z.32	47033066 5140243
8160 - 8260 - 8360 - 8560 - F100 - F110 - F115 - F120 - F130 - F140 - M100 - M115 - M135 - M160 - TM115 - TM125 - TM135 - TM150 - TM165	15820	Disco freno	Sinterizzato	327x60x10 76x60 - Z.14	5154521
5610S - 6610S - 6810S - 7010 - 7610S - 7810S - 8010 - 5640 - 6640 - 7740 - 8340 - 8240 - 7840 TS100 - TS110 - TS115 - TS80 - TS90 T6.120	 15775	Disco freno	Sinterizzato	224x154x4,8 60x54 - Z.22	83989830 87518036 48032943 48032945
62-85 - 62-85M - 72-85 - 72-85M - 82-85M - 88-85M TK100A - TK4040 - TK4040M - TK4050 - TK4050M - TK4060 - TK75M - TK75MA - TK76 - TK76M - TK80A - TK80MA - TK85 - TK85M - TK90A - TK90MA - TK95M TK4.100 - TK4.100 - TK4.100M - TK4.100M - TK4.110 - TK4.110 - TK4.110M - TK4.110M - TK4.90 - TK4.90 - TK4.90M - TK4.90M	 15130	Disco freno	Acciaio	228x127x2,65	5163734
	16275	Disco freno	Sinterizzato	223,75x75 78x48 - Z.29	5161932

MODELLO	ARTICOLO	DESCRIZIONE	MATERIALE	DIMENSIONI mm	OEM
GOLDONI					
3000 - STAR 3000 - COMPACT - QUASAR - STAR 4000 Q - STAR 50/70 - STAR QUADRIFOGLIO	16029	Disco freno	Sinterizzato	165x110x5 40x36 - Z.20	00041480 00043325 00064139
	15254	Disco freno	Acciaio	171,7x94,3x2,65	00018017
ASTER - RONIN CLUSTER RS/SN/REVERSIBILE MAXTER RS/SN/REVERSIBILE	16183	Disco freno	Sinterizzato	143x90x5,0 - Z.18	00033594
	16184	Disco freno	Acciaio	-	00040974
BOXTER IDEA IDEA 35-37-40 - HST	15251	Disco freno	Sinterizzato	101x28x5,2 30x28 - Z.23	00025834
	16188	Disco freno	Acciaio	108x50x2,65 2 tacche esterne	00028021

HURLIMANN

H-345 - H-355 - H-360 - H-470	15255	Disco freno	Conglomerato	178x101x4,8 48x44 - Z.23	0.177.5434.3
	15164	Anello per disco 15255	Conglomerato	-	0.136.5435.0
4351	15251	Disco freno	Sinterizzato	101x28x5,2 30x28 - Z.23	0.151.5469.0
	15469	Disco freno	Acciaio	108x50x2,7	0.151.5468.0
H-351 - H-355F - H-360 - H-361 - H-361F - H-361V - H-470 - H-476F	15470	Disco freno	Sinterizzato	178x44x5 48x44 - Z.23	0.256.5434.0
	15471	Disco freno	Acciaio	184x114x2,65	0.177.5475.0
H5160 - H6160 (Fino al Tel. N° 00161)	15476	Disco freno	Sinterizzato	224x55x4,8 60x55 - Z.27	0.154.5459.0
	15130	Disco freno	Acciaio	228x127x2,65	0.154.5460.0
Elite H6115XB - H61635XB Prestige H478 - 488T XB105 - XB MAX100 / TRADITION - MAX110 XBT-TB 100T - 100TB XT 105 - 110 - 908 - 909 - 910.4 - 910.6 - 911 - 913	 16273	Disco freno	Sinterizzato	Ø 280 - Z.12	0.011.3765.2
H4105 Elite - H476 - H476.4 - H478 - H478.4 - H486T - H488T - H6115 Elite - H6135 Elite PRESTIGE 95 Tradition XB85 - XB85T - XB95 - XB95T XT95 - XT115 - XT130 - XT85 - XT908 - XT909 - XT910.4 - XT911 - XT913	 16274	Disco freno	Sinterizzato	Ø 282 46,5x60 - Z.12	0.009.7067.2 0.445.5447.2 0.445.5447.2/10
Joker XA - XE - XF - XN - XS - XV	 16278	Disco freno	Sinterizzato	Ø 225 38x49 - Z.12	0.008.5173.2 0.011.0587.2 0.015.4482.2

LAMBORGHINI

R483 - 483DT - R503 - 503DT - R603 - 603DT - R583 - 583DT - R653 - 653DT - R654 - 654DT	15255	Disco freno	Conglomerato	178x101x4,8 48x44 - Z.23	0.177.5434.3
	15164	Anello per disco 15255	Conglomerato	-	0.136.5435.0
R483 - 483DT - R550 - 550DT - R583 - 583DT - R653 - 653DT - R654 - 654DT - 653 Frutteto - R683 - 683DT - R684 - 684DT - R684DT Frutteto - R724 - 724DT - 660 - 660DT - 660F - 660V - 775	15470	Disco freno	Sinterizzato	178x44x5 48x44 - Z.23	0.256.5434.0/10
	15471	Disco freno	Acciaio	184x114x2,65	0.256.5456.0
R480 - 480DT - R485 - 485DT - R490 - R704 - R704DT - R804 - 804DT - R904 - 904DT	15472	Disco freno	Sinterizzato	224x53x4,8 60x53 - Z.22	0.427.5434.0
	15473	Disco freno	Acciaio	228x127x2,65	0.154.5460.0/10
R235 - R235DT - R235S	15133	Disco freno	Conglomerato	102x51x4,5 31x28,5 - Z.23	0.159.5434.3
	15479	Anello per disco 15133	Conglomerato	-	0.159.5435.0
R240 - 240DT - R350 - 350DT - R503 - 503DT - R603 - 603DT	15131	Disco freno	Conglomerato	152x80x4,8 48x44 - Z.23	0.422.5434.3
	15135	Anello per disco 15131	Conglomerato	-	0.422.5435.0
R235 - R345 - R345DT - R345F	15251	Disco freno	Sinterizzato	101x28x5,2 30x28 - Z.23	0.151.5469.0
	15469	Disco freno	Acciaio	108x50x2,7	0.151.5468.0

Dischi e anelli freno

DISC BRAKE PADS-BRAKE FACING

11

11

MODELLO	ARTICOLO	DESCRIZIONE	MATERIALE	DIMENSIONI mm	OEM
segue LAMBORGHINI					
Formula 115 - 135 Grand Prix 774-80 - 874-90T Premium 1050 - 1060 - 1100 - 1300 - 850 - 950 R3.100 - 105 - 90 - 95 - 110 R4.105 - 110	16273	Disco freno	Sinterizzato	Ø 280 - Z.12	0.011.3765.2
Formula 105 - 115 - 135 R774 - R774/80 - R874T - R874/90T Premium 1050 - 850 - 950 - 1100 - 1300 774/80N - 774/85 Cross N - 874/95 Cross N Grand Prix 95 Target R3.75 - R3.85 - R3.85T - R3.95 - R3.95T - R3.95TB R4.85 - R4.95 R5.100 - R5.115 - R5.130	16274	Disco freno	Sinterizzato	Ø 282 46,5x60 - Z.12	0.009.7067.2 0.445.5447.2 0.445.5447.2/10
Agile Crono Lampo R2 Rekord RF - RS - RV Spire Sprint	16278	Disco freno	Sinterizzato	Ø 225 38x49 - Z.12	0.008.5173.2 0.011.0587.2 0.015.4482.2

LANDINI





R3200 - R5000 - R5000 Special - R5000 MKz - R6000 Special MK3 - 6000DT	15474	Disco freno	Conglomerato	143x85x4,8 41,5x36 - Z.10	1432328M91
	15249	Anello per disco 15474	Conglomerato	-	1422434M91
R5500 - R6500 - R6550 - R6550/4 - R6550 Velox Drive - R7500 - R7550 - R8500DT	15475	Disco freno	Conglomerato	165x85x4,8 45x38 - Z.13	1823112M91
	15134	Anello per disco 15475	Conglomerato	-	1423617M91 3305272M91
R10000DT - 10000S - 10000MKz - R12000DT - 12500 - 13000 - 13000MKz (dal 11-87) - 14500 Turbo - 14500 MKz (dal 11-87) - LANDPOWER - LEGEND Serie 6	15476	Disco freno	Sinterizzato	224x55x4,8 60x55 - Z.27	1860964M2
	15130	Disco freno	Acciaio	228x127x2,65	1860965M2
R8550DT - R8550DT Velox Drive - 5530F-F. DT - 5530L-V - 6530F-F.DT - 6530L-V - 6030L Turbo - 6030F Turbo - 6030V Turbo	15477	Disco freno	Conglomerato	178x101x4,8 45x38 - Z.13	3302699M91
	15164	Anello per disco 15477	Conglomerato	-	1895853M91
R8000 - R8000 Special - R9000 Special	15478	Disco freno	Conglomerato	178x101x4,8 59x55 - Z.27	1753117M91
	15164	Anello per disco 15478	Conglomerato	-	1845853M91 840916M92
65/75/85 GT-F - 5530F/FDT/L/V - 6530F/ FDT/L/V - 6030L/F/V TURBO - 7530L - 8530F/L - R-DT: 5860-5870-6060-6070-6680-6860- 6870-7830-7860-7870-4880-8830-8860- 8870-8880-9880 ADVANTAGE: L55/60/65/75/85 FP-LP BLIZZARD: L50/60/65/75/85/95 GLOBE - GHIBLI - GLOBALFARM - MULTIFARM - POWERFARM - POWERMONDIAL - REX - Serie 4D/5H - TREKKER - VISION	15875	Disco freno	Acciaio - Carta	178x140x4,8 48x44 - Z.23	3671530M2 3550896M1 3308295M2
	16122	Disco freno Maggiorato	Grafitico		
	15471	Disco freno	Acciaio	184x114x2,65	3308296M2

MASSEY FERGUSON

MF135 - 148 - 152 - MF765 - MF1104	15478	Disco freno	Conglomerato	178x101x4,8 59x55 - Z.27	1753117M91
	15164	Anello per disco 15478	Conglomerato	-	840916M92
MF133 MK3 - 135 MK3 Francia - Export - 148 MK3 - MF165 - 168 - 175 - 178 - 185 - 188 - 235 - 245 - 265 - 250 - 260 - 290 (Europa) - 255 - 275 - 285 - 290 - 298 (Francia) - 350 - 355 - 365 - 353 - 363 - 373 - 375 - 390 - 398 - 399 - 550 - 560 - 565 - 575 - 590 - 595 - 595 MK2 - 675 - 675/4 - 690 - 690/4 - 698 - 698/4 - 699 - 699/4 - 1080 - 1080.8 - 1080.8 Super - 1014 - 1024 - 1114 - 1124 - 1134	15476	Disco freno	Sinterizzato	224x55x4,8 60x55 - Z.27	1860964M2
	15130	Disco freno	Acciaio	228x127x2,65	1860965M2
MF134 - 134S/4 - 154S/4 - 174 - 174S - MF184 - 194 - 233 - 253 - 263 - 273 - MF254 - 264 Turbo - 274 (fino al tel. 2211008) - MF284S - 284/4S - 294S (fino al tel. 12600657)	15475	Disco freno	Conglomerato	165x85x4,8 45x38 - Z.13	1823112M91
	15134	Anello per disco 15475	Conglomerato	-	1423617M91

MODELLO	ARTICOLO	DESCRIZIONE	MATERIALE	DIMENSIONI mm	OEM
segue MASSEY FERGUSON					
254 - 264 Turbo - 274 (dal tel. 22111009) - 284S - 284/4S - 294S (dal tel. 126C00658)	15477	Disco freno	Conglomerato	178x101x4,8 45x38 - Z.13	3302699M91
	15164	Anello per disco 15477	Conglomerato		3303240M91
MF765 - 1104 - Sirenetta	15478	Disco freno	Conglomerato	178x101x4,8 59x55 - Z.27	1753117M91
	15164	Anello per disco 15478	Conglomerato		840916M91

SAME

Aurora 45 - Vigneron 35-45	15133	Disco freno	Conglomerato	102x51x4,5 31x28,5 - Z.23	0.159.5434.3
	15479	Anello per disco 15133	Conglomerato		0.159.5435.0
Centurion 75 Export - Condro 55 synchro - Corsaro 70 - Corsaro 70 synchro - Corsaro frutteto - Minitaurus 60 synchro - Saturno - Saturno 80 synchro - Taurus 60 Export - Vigneron 60-62	15477	Disco freno	Conglomerato	178x101x4,8 45x38 - Z.13	0.158.5434.3
	15164	Anello per disco 15477			0.136.5435.0
Centauro 70 Export - Centauro 70 Special - Centurion 75 Special - Galaxy 170 Turbo - Hercules 160 Export (dal Tel. 1241) - Mercury 85 Special	15476	Disco freno	Sinterizzato	224x55x4,8	0.154.5459.0/10
	15473	Disco freno	Acciaio	228x127x2,63	0.154.5460.0/10
Delfino 32-35 - Ranger 45 - 45 Frutteto - Vigneron 50	15251	Disco freno	Sinterizzato	101x28x5,2 30x28 - Z.23	0.151.5469.0
	15469	Disco freno	Acciaio	108x50x2,7	0.151.5468.0
Drago 100 - 120 - Hercules 160 Export (fino al Tel. 1240) - Panther 95	15476	Disco freno	Sinterizzato	224x55x4,4 60x55 - Z.27	0.154.5459.0
	15130	Disco freno	Acciaio	228x127x2,65	0.154.5460.0
Frutteto 60-75 - Solar 50	15470	Disco freno	Sinterizzato	178x44x5 48x44 - Z.23	0.256.5434.0/10
	15471	Disco freno	Acciaio	196,6x183,7x2,65	0.256.5456.0
Leopard 80-90 - Tiger 100 Titan 145-160-190 - Trident 130	15818	Disco freno	Sinterizzato	304x51x10 68x50 - Z.12	0.170.5434.0/12
Argon - Dorado - Frutteto - Golden	 16231	Disco freno	Sinterizzato	178x44x5 Z.15	0.008.5343.2
Explorer II / Special / T-TB Frutteto II Aster Condor Corsaro Explorer Falcon Minitaurus Saturno Taurus Vigneron	 16271	Disco freno anteriore	Sinterizzato	178x38x5,2 Z.13	0.194.5464.2
	16272	Disco freno	Acciaio	181x100x2,6	0.270.4351.0
Antares II 110 - 130 Explorer 90 - 95 - 100 Explorer II 80 - 90 Explorer 100T - 100TB - 105T Laser 110 Silver 100.4 - 100.6 - 105 - 110 - 130 - 80 - 90	 16273	Disco freno	Sinterizzato	Ø 280 - Z.12	0.011.3765.2
Antares 100 - 110 - 130 Explorer 75 - 80 - 85 - 90 - 95 Explorer II 85 - 95 Laser 100 Silver 80 - 85 - 90 - 95 - 100.4 - 110 - 115 - 130	 16274	Disco freno	Sinterizzato	Ø 282 46,5x60 - Z.12	0.009.7067.2 0.445.5447.2 0.445.5447.2/10
Argon Dorado Explorer Frutteto Golden Roller Same Trem II Tiger	 16278	Disco freno	Sinterizzato	Ø 225 38x49 - Z.12	0.008.5173.2 0.011.0587.2 0.015.4482.2

Dischi frizioni idrauliche

HYDRAULIC CLUTCH DISCS

11

11 INNESTO DELLA TRASMISSIONE A 4 RUOTE MOTRICI - FRIZIONE

ENGAGEMENT DE LA TRANSMISSION 4 ROUES MOTRICES - EMBRAYAGE
 4WD POWER TRANSMISSION - CLUTCH
 4WD GETRIEBE - KUPPLUNG
 4WD TRANSMISIÓN - EMBRAGUE

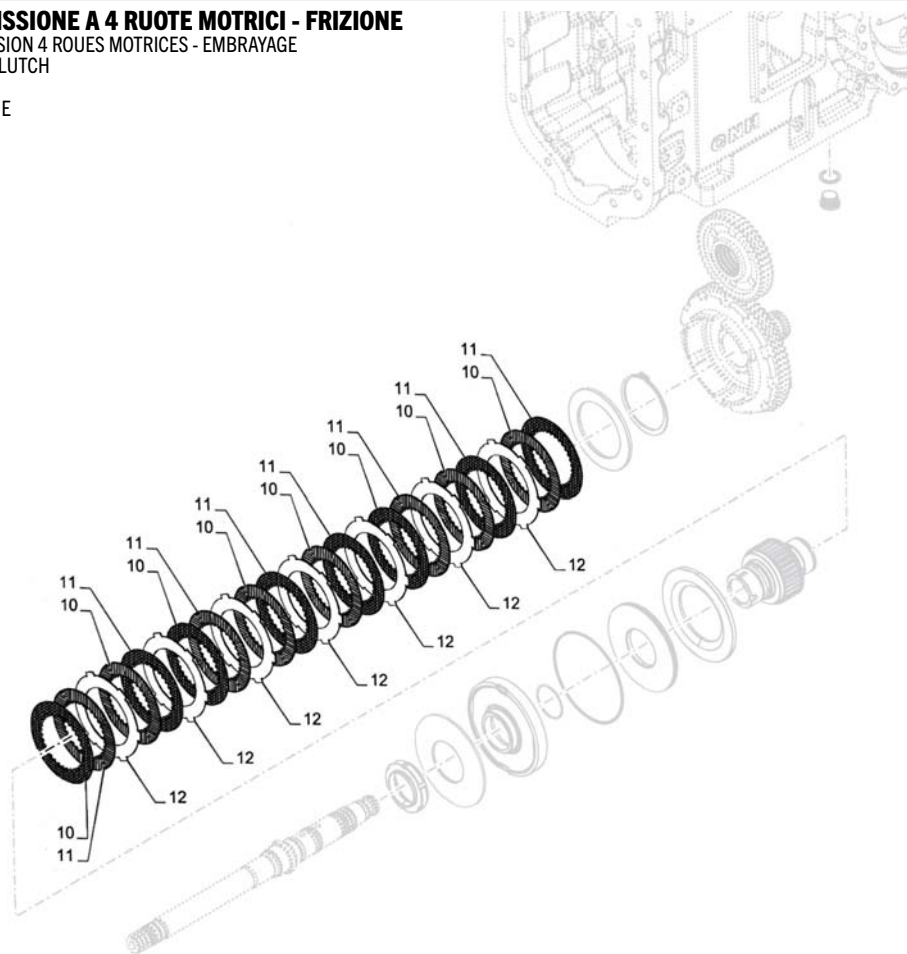

ARTICOLO	MATERIALE	DIMENSIONI mm	OEM	APPLICAZIONI	RIF.
15817	Carta	140x91x1,80 - Z.32	5163844 - 5163904	NEW HOLLAND	10
15821	Carta	140x91x1 - Z.32	5159755	Serie T6: .120 / .125 / .145 / .150 / .160 / .175 / .180	11
15811	Acciaio	152x100x1,50 - Z.50	5143721	Serie T6000: T6010 - T6020 - T6030 - T6040 - T6050 - T6060 - T6070	12

FRIZIONE A COMANDO IDRAULICO PER INNESTO DOPPIA TRAZIONE (4WD)

EMBAYAGE HYDRAULIQUE POUR ENGAGEMENT DOUBLE TRACTION (4WD)
 4WD HYDRAULIC CLUTCH
 4WD HYDRAULISCHE KUPPLUNG
 4WD EMBRAGUE HIDRÁULICO

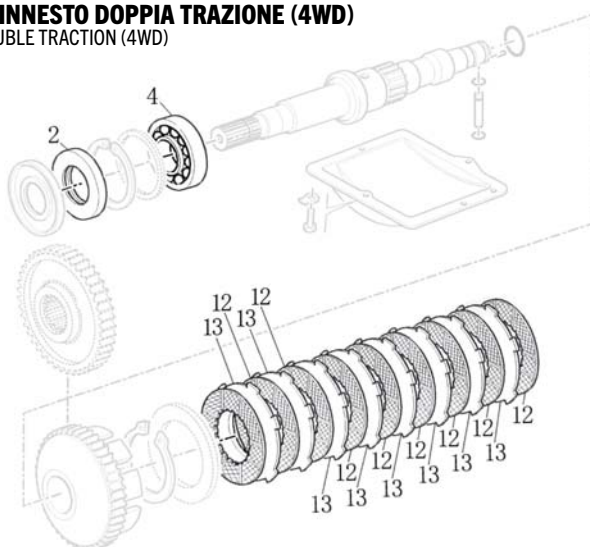

ARTICOLO	MATERIALE	DIMENSIONI mm	OEM	APPLICAZIONI	RIF.
15817	Carta	140x91x1,80 - Z.32	5163904	NEW HOLLAND	12
15810	Acciaio	152x100x1,50 - Z.6	5163840	Serie TM: TM115 - TM120 - TM125 - TM130 - TM140 - TM150 - TM155 - TM165 - TM175	13
64432	-	40x80x12	5125897	Serie 60: 8160 - 8260 - 8360 - 8560	2
62931	-	40x80x19,75	26799960		4

FRIZIONE PRESA DI FORZA

EMBRAYAGE DE PRISE DE FORCE
P.T.O. CLUTCH DISK
ZAPFWELLESKUPPLUNG
EMBRAGUE DE TOMA DE FUERZA

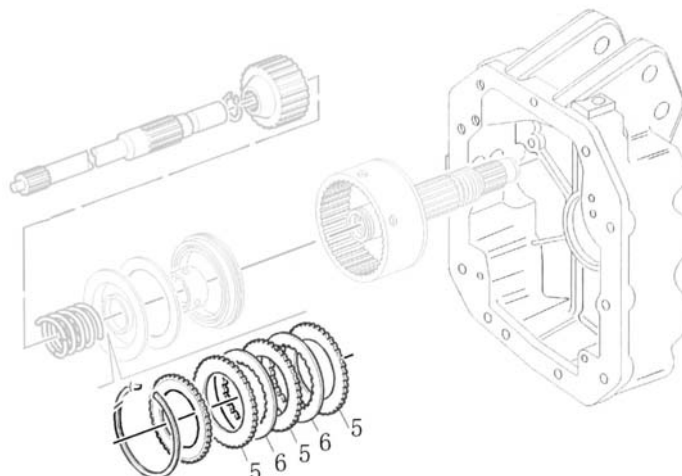

ARTICOLO	MATERIALE	DIMENSIONI mm	OEM	APPLICAZIONI	RIF.
15811	Acciaio	152x100x1,50 - Z.50	5143721	NEW HOLLAND Serie 60: 8160 - 8260 - 8360 - 8560 Serie M: M100 - M115 - M135 - M160 Serie F: F100 - F115 - F130 - F140	5
15816	Carta	140x91x2,5 - Z.32	5158919		6

BLOCCAGGIO DIFFERENZIALE PER ASSE RUOTA RINFORZATO - RUOTISMI RINVIO (4WD)

BLOCAGE DE DIFFÉRENTIEL RENFORCÉ - (4WD)
REINFORCED DIFFERENTIAL LOCK - (4WD)
VERSTÄERKTE DIFFERENTIALSPERRE - (4WD)
BLOQUEO DIFERENCIAL REFORZADO - (4WD)

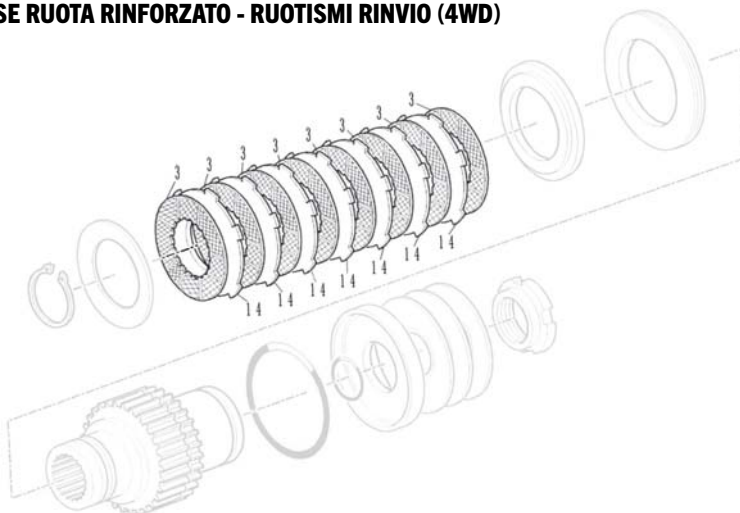

ARTICOLO	MATERIALE	DIMENSIONI mm	OEM	APPLICAZIONI	RIF.
15817	Carta	140x91x1,80 - Z.32	5163904	NEW HOLLAND Serie TSA: TS100A - TS110A - TS115A - TS125A - TS135A	3
15810	Acciaio	152x100x1,50 - Z.6	5163840 - 84177629		14

ALLESTIMENTO CAMBIO HI-LO

ÉQUIPEMENT DE BOÎTE DE VITESSE
HI-LO GEARBOX EQUIPMENT
HI-LO GETRIEBE
CAJA DE CAMBIO HI-LO

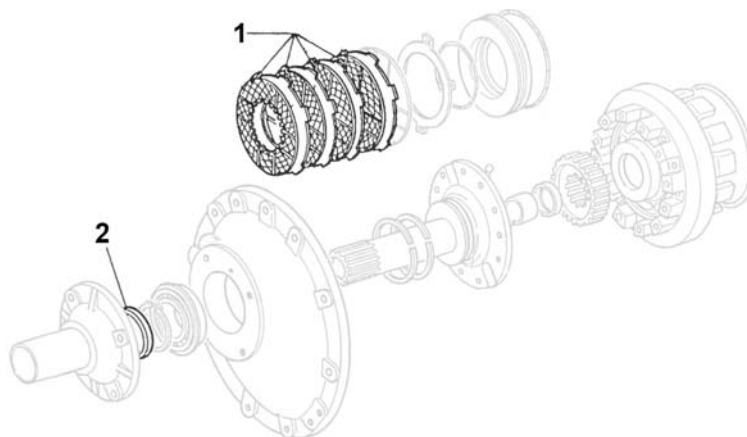

ARTICOLO	MATERIALE	DIMENSIONI mm	OEM	APPLICAZIONI	RIF.
15821	Carta	140x91x1 - Z.32	5159755 - 5143863	FIAT Serie F: F100 - F110 - F120 - F130	1
65157	-	55x70x8	5112307		2

Attuatori Freno

BRAKE ACTUATOR

11

ATTUATORE 4"

ACTIONNEUR 4"
4" ACTUATOR
AKTUATOR 4"
ACTUADOR 4"

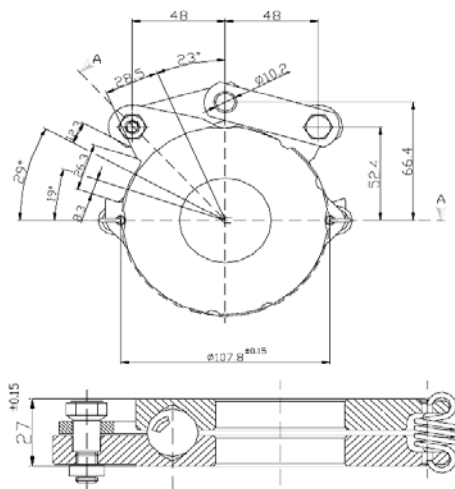

ARTICOLO	DESCRIZIONE	APPLICAZIONE	OEM
15781	Funzionamento a secco	SAME	0.159.5432.3

ATTUATORE 7"

ACTIONNEUR 7"
7" ACTUATOR
AKTUATOR 7"
ACTUADOR 7"

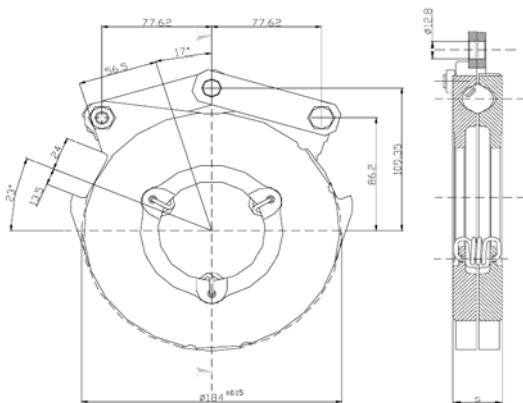

ARTICOLO	DESCRIZIONE	APPLICAZIONE	OEM
15779	Funzionamento a secco	LANDINI - MF	1895334M91

ATTUATORE 7"

ACTIONNEUR 7"
7" ACTUATOR
AKTUATOR 7"
ACTUADOR 7"

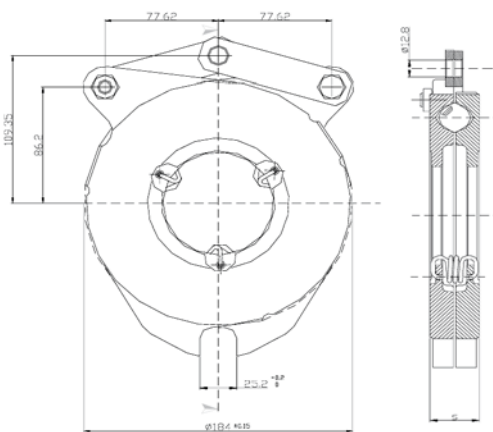

ARTICOLO	DESCRIZIONE	APPLICAZIONE	OEM
15780	Funzionamento bagno d'olio	LANDINI - MF	3308792M91 3304634M91 6531756M92 6531756M91

ATTUATORE 6,5"

ACTIONNEUR 6,5"
6,5" ACTUATOR
AKTUATOR 6,5"
ACTUADOR 6,5"

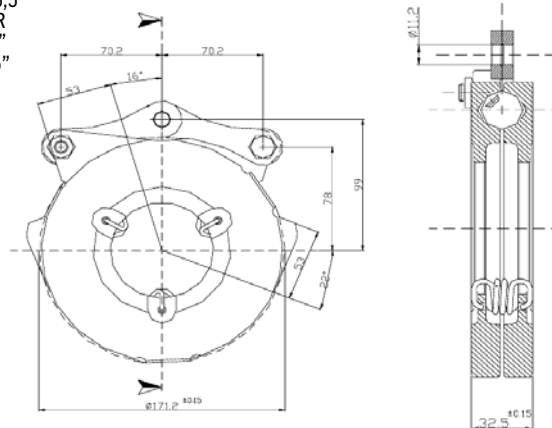

ARTICOLO	DESCRIZIONE	APPLICAZIONE	OEM
15777	Funzionamento bagno d'olio	FIAT	5129473
15778	Funzionamento a secco	LANDINI - MF	1822606M92

ATTUATORE 7"

ACTIONNEUR 7"
7" ACTUATOR
AKTUATOR 7"
ACTUADOR 7"



ARTICOLO	DESCRIZIONE	APPLICAZIONE	OEM
16270	Funzionamento a secco	SAME LAMBORGHINI	0.199.5434.4 0.136.5432.3 0.201.5432.3 0.005.1287.3

ATTUATORE 8" 3/4

ACTIONNEUR 8" 3/4
8" 3/4 ACTUATOR
AKTUATOR 8" 3/4
ACTUADOR 8" 3/4



ARTICOLO	DESCRIZIONE	APPLICAZIONE	OEM
16255	Funzionamento bagno d'olio	LANDINI - MF - SAME - FIAT	1860963M92 0.154.5461.0 3538836M91 5161929

GUARNIZIONI PER FRENI
JOINTS MOTEUR - BRAKE GASKETS - BREMSDICHTUNGEN - GÁSQUET PARA FRENOS



ARTICOLO	DESCRIZIONE	DIMENSIONI mm	OEM
CNH			
16236	Anello di tenuta per freni CNH	189,6x3,40	8138821
16237	Anello di tenuta per freni CNH	259,1x3,40	5105538 / 5169561
16238	Anello di tenuta per freni CNH	306,4x3,40	5105540 / 5169562
16239	Anello di tenuta per freni CNH	210,8x3,40	87388219
16240	Anello di tenuta per freni CNH	263,6x3,40	87388213

ARTICOLO	DESCRIZIONE	DIMENSIONI mm	OEM
SAME - LAMBORGHINI - DEUTZ - HÜRLIMANN			
16241	Anello di tenuta per freni	215,6x3,40	0.275.4354.0/20
16242	Anello di tenuta per freni	143,6x3,40	0.270.4353,0/20
16243	Anello di tenuta per freni	215,6x3,40	0.275.4353.0/10
16244	Anello di tenuta per freni	174,6x3,40	0.270.4354.0/30
16245	Anello di tenuta per freni	127,4x3,40	0.007.7643.0
16246	Anello di tenuta per freni	279,0x3,53	2.1539.179.0
16247	Anello di tenuta per freni	228,0x3,53	2.1539.180.0
16279	Anello di tenuta per freni	171,0x3,53	2.1539.177.0
16280	Anello di tenuta per freni	221,8x3,53	2.1539.178.0

Placchette sinterizzate e pastiglie freno

SINTERED PLATES - BRAKE PADS

11

11

PLACCHETTE SINTERIZZATE

PLAQUETTES - BUTTONS - GESINTERT PLAETTCHEN - PASTILLE SINTERIZATE

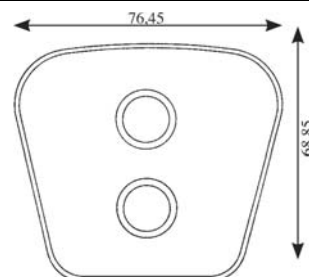
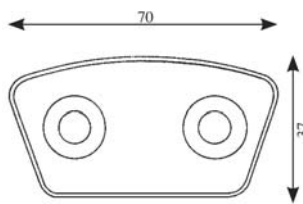
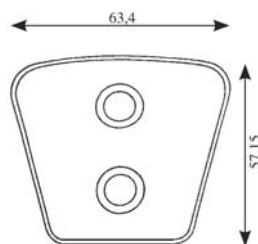

ARTICOLO	SPESSORE	NOTE
15448	3,60 mm	Le placchette sono fornite complete di rivetti.
15449	4,00 mm	

ARTICOLO	SPESSORE	NOTE
15450	3,60 mm	Le placchette sono fornite complete di rivetti.
15451	4,00 mm	

ARTICOLO	SPESSORE	NOTE
15452	3,60 mm	Le placchette sono fornite complete di rivetti.
15453	4,00 mm	
15454	4,80 mm	

PASTIGLIE FRENI DI STAZIONAMENTO

PLAQUETTE DE FREIN
BRAKES HANDS
STANDBREMSE BELAGEN
PASTILLAS FRENO DE ESTACIONAMENTO



ARTICOLO	MATERIALE	OEM	APPLICAZIONI
15264	Sinterizzato (Ferodo da 1 lato)	5104773 5158941 5158120	AGRIFULL: 80.60 - 80.75 - 80.85 - 80.60V-F - 80.70 - 80.70F - 90 - 90DT - 100 - 100DT - 110 - 110DT - 90E - 90E DT - 100E - 100E DT - 110E - 110E DT - 140 - 140DT Turbo - 80.95 - 80.105.
15813	Carta (Ferodo da 1 lato)	5158120 5158941 5104773	FIAT: 570 Vigneto - Frutteto - Frutteto DT - 570 - 570DT - 580 - 580DT - 670 - 670DT - 680 - 680DT - 670 Frutteto - Frutteto DT - 780 - 780DT - 880 - 880DT - 880/5 - 880/5DT - 980 - 980DT - 1180 - 1180DT - 1280 - 1280DT - 1380 - 1380DT - 1580 - 1580DT - 1580DT Turbo - 1880 - 1880DT - 780E - 780E DT - 800E - 800E DT - 980E DT - 90.90 - 90.90DT - 100.90 - 100.90DT - 110.90 - 110.90DT - 115.90 - 115.90DT - 130.90 Turbo - 130.90DT Turbo - 140.90 Turbo - 140.90DT Turbo - 160.90 Turbo - 160.90DT Turbo - 180.90 Turbo - 180.90DT Turbo.
15265	Sinterizzato (Ferodo da 2 lati)	5104774	
15812	Carta (Ferodo da 2 lati)	5105817 5158123 5105815	
15481	Sinterizzato	5118095	AGRIFULL: 70 - 70DT - 70E - 70E DT - 80 - 80DT - 80E - 80E DT - 80F - 80F DT - 80.46F - 80.56 - 80.56E - 80.66 - 80.66E - 80.76E - 80.76E.
15482	Sinterizzato	5118100	FIAT: 366 - 366DT - 466 - 466DT - 566 - 566DT - 566E - 566E DT - 666 - 666DT - 666E - 666E DT - 766 - 766DT - 766E - 766E DT - 55.90 - 55.90DT - 60.90 - 60.90DT - 65.90 - 65.90DT - 70.90 - 70.90DT - 80.90 - 80.90DT - 55.56 - 55.56DT - 60.56 - 60.56DT - 65.56 - 65.56DT - 70.56 - 70.56DT - 55.66 - 55.66DT - 55.66LP - 60.66 - 60.66DT - 60.66LP - 65.66DT - 70.66LP - 70.66LP DT - 80.66F - 80.66F DT - 80 - 66 - 80 - 66DT.
15483	Sinterizzato	0.171.5451.2	HURLIMANN: H335 - H356 - H358 - H358.4 - H358 Prestige - H360 - H362 - H372 - H466 - H466.4 - H468 - H468.4 - H468.4 Prestige - H470 - H476 - H476.4 - H478 - H478.4 - H478T Prestige - H488T Prestige - H480 - H486T - H488T - H496T - H5110 - H5160 - H6160 - H6136. LAMBORGHINI: R573.60N - R574.60N - R674 - R674.5 - R674.70N - R674.70 Gran Prix - R684 - R684DT - R684DT Frutteto - R724 - R724DT - R754 - R754DT - R784 - R784DT - R854 - R854DT - R774 - R774DT - R955 - R955DT - R956 - R956.100 - R1106 - R1106DT - R1056 - R1156 - R1256 - R1306 Turbo DT - R1356DT - R1506 Turbo DT - R1556DT - 600 - 700 Turbo - 774.5 - 774.80 - 774.80N - 774.80 Gran Prix - 874 Turbo - 874.90 T Gran Prix.
15484	Sinterizzato	0.171.5459.2	SAME: Aster 60-70 - Explorer 55-60-60 II ^a - 60 Special - 65-65 Special - 70 II ^a - 70 Special - 75-80 II ^a - 80 Special - 90 II ^a Turbo - Jaguar 95 Export - Laser 90 - 100 - 110 - Leopard 90 Turbo - Tiger 100 - Tiger SIX 105 Export - Trident 130 Export - Explorer 90 II ^a
15485	Sinterizzato	3302.353. M1	LANDINI: R10000 DT - 100000 S - 10000 MK2 - R12000 DT - R12500 - 13000 - 13000 MK2 (dal 11/87) - R14500 Turbo - 14500 MK2 (dal 11/87) - R5530 F - F. DT - 5530 L - V - 6530 F - F. DT - R 6530 L - V - 6030 L Turbo - F
15486	Sinterizzato	3302.354. M1	Turbo - V Turbo - R5830 DT - R6830 DT - R7530 F - F DT - 7530 L - R8530 F - L - R7830 DT - R8830 DT.
15776	Sinterizzato	3.000.18384 3.209.65550	LAVERDA: 3350 - AM1200 - M100 - M1000AL - M112 - M120 - M130 - M150 - M152 - TA150